



VLT®  
HVAC Basic Drive



# Programming Guide

VLT® HVAC Basic Drive

Contents

<b>1 Introduction</b>	<b>5</b>
1.1.1 Copyright, Limitation of Liability and Revision Rights	5
1.1.2 Symbols	6
1.1.3 Abbreviations	6
1.1.5 Definitions	7
1.1.6 Electrical Overview	11
<b>2 How to Programme</b>	<b>12</b>
2.1 Programming with MCT-10 Setup software	12
2.2 Local Control Panel (LCP)	12
2.3 Menus	13
2.3.1 Status	13
2.3.2 Quick Menu	13
2.3.3 The FC101 Start-up Wizard for Open Loop Applications	13
2.3.4 Main Menu	18
2.4 Quick Transfer of Parameter Settings between Multiple Frequency Converters	19
2.5 Read-out and Programming of Indexed Parameters	19
2.6 Initialise the Frequency Converter to Default Settings in two Ways	19
<b>3 Parameters</b>	<b>20</b>
3.1 Main Menu - Operation and Display - Group 0	20
3.1.1 0-0* Basic Settings	20
3.1.2 0-1* Define and set-up Operations	21
3.1.3 0-3* LCP Custom Readout	22
3.1.4 0-4* LCP	23
3.1.5 0-5* Copy / Save	23
3.1.6 0-6* Password	23
3.2 Main Menu - Load and Motor - Group 1	24
3.2.1 1-0* General Settings	24
3.2.2 1-2* Motor Data	24
3.2.3 1-3* Adv. Motor Data	26
3.2.4 1-4* Cable Length	26
3.2.5 1-5* Load Indep. Setting	26
3.2.6 1-6* Load Depend. Setting	27
3.2.7 1-7* Start Adjustments	27
3.2.8 1-8* Stop Adjustments	28
3.2.9 1-9* Motor Temperature	28
3.3 Main Menu - Brakes - Group 2	29
3.3.1 2-1* Overvoltage Control	29
3.4 Main Menu - Reference/Ramps - Group 3	30

3.4.1 3-0* Reference Limits	30
3.4.2 3-1* References	30
3.4.3 3-4* Ramp 1	31
3.4.4 3-5* Ramp 2	31
3.4.5 3-8* Other Ramps	32
3.5 Main Menu - Limits/Warnings - Group 4	33
3.5.1 4-1* Motor Limits	33
3.5.2 4-5* Adj. Warnings	33
3.5.3 4-6* Speed Bypass	34
3.6 Main Menu - Digital In/Out - Group 5	35
3.6.1 5-0* Digital I/O Mode	35
3.6.2 5-1* Digital Inputs	35
3.6.3 5-4* Relays	38
3.6.4 5-9* Bus Controlled	40
3.7 Main Menu - Analog In/Out - Group 6	41
3.7.1 6-0* Analog I/O Mode	41
3.7.2 6-1* Analog Input 53	41
3.7.3 6-2* Analog Input 54	42
3.7.4 6-7* Analog/Digital Output 45	42
3.7.5 6-9* Analog/Digital Output 42	44
3.8 Main Menu - Communications and Options - Group 8	46
3.8.1 8-0* General Settings	46
3.8.2 8-3* FC Port Settings	46
3.8.3 8-5* Digital/Bus	47
3.8.4 8-7* BACnet	48
3.8.5 8-8* FC Port Diagnostics	49
3.8.6 8-9* Bus Feedback	49
3.9 Main Menu - Smart Logic - Group 13	50
3.9.1 13-** Prog. Features	50
3.9.2 13-0* SLC Settings	50
3.9.3 13-1* Comparators	52
3.9.4 13-2* Timers	53
3.9.5 13-4* Logic Rules	53
3.9.6 13-5* States	56
3.10 Main Menu - Special Functions - Group 14	58
3.10.1 14-0* Inverter Switching	58
3.10.2 14-1* Mains On/Off	58
3.10.3 14-2* Trip Reset	58
3.10.4 14-4* Energy Optimising	59
3.10.5 14-5* Environment	59

3.11 Main Menu - Drive Information - Group 15	61
3.11.1 15-0* Operating Data	61
3.11.2 15-3* Alarm Log	61
3.11.3 15-4* Drive Identification	61
3.12 Main Menu - Data Readouts - Group 16	63
3.12.1 16-0* General Status	63
3.12.2 16-1* Motor Status	63
3.12.3 16-3* Drive Status	64
3.12.4 16-5* Ref. & Feedb.	64
3.12.5 16-6* Inputs and Outputs	65
3.12.6 16-8* Fieldbus & FC Port	66
3.12.7 16-9* Diagnosis Read-Outs	66
3.13 Main Menu - Data Readouts 2 - Group 18	67
3.13.1 18-1* Fire Mode Log	67
3.14 Main Menu - FC Closed Loop - Group 20	67
3.14.1 20-0* Feedback	67
3.14.2 20-8* PI Basic Settings	67
3.14.3 20-9* PI Controller	68
3.15 Main Menu - Application Functions - Group 22	69
3.15.1 22-4* Sleep Mode	69
3.15.2 22-6* Broken Belt Detection	70
3.16 Main Menu - Application Functions 2 - Group 24	71
3.16.1 24-0* Fire Mode	71
3.16.2 24-1* Drive Bypass	72
<b>4 Troubleshooting</b>	<b>74</b>
4.1.1 Alarm Words	76
4.1.2 Warning Words	76
4.1.3 Extended Status Words	77
4.1.4 Fault Messages	77
<b>5 Parameter Lists</b>	<b>80</b>
5.1 Parameter Options	80
5.1.1 Default settings	80
5.1.2 0-** Operation / Display	81
5.1.3 1-** Load and Motor	82
5.1.4 2-** Brakes	83
5.1.5 3-** Reference/Ramps	83
5.1.6 4-** Limits/Warnings	84
5.1.7 5-** Digital In/Out	84
5.1.8 6-** Analog In/Out	85

5.1.9 8-** Comm. and Options	86
5.1.10 13-** Smart Logic	87
5.1.11 14-** Special Functions	87
5.1.12 15-** Drive Information	88
5.1.13 16-** Data Readouts	89
5.1.14 18-** Info & Readouts	90
5.1.15 20-** Drive Closed Loop	90
5.1.16 22-** Appl. Functions	90
5.1.17 24-** Appl. Functions 2	91
<b>Index</b>	<b>92</b>

## 1 Introduction

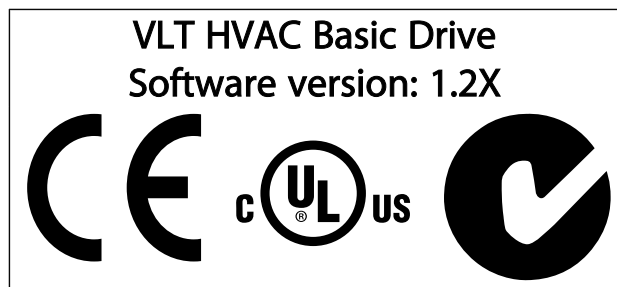

This guide can be used with all VLT HVAC Basic Drive frequency converters with software version 1.2X.  
The actual software version number can be read from *15-43 Software Version*.

### 1.1.1 Copyright, Limitation of Liability and Revision Rights

This publication contains information proprietary to Danfoss. By accepting and using this manual the user agrees that the information contained herein will be used solely for operating equipment from Danfoss or equipment from other vendors provided that such equipment is intended for communication with Danfoss equipment over a serial communication link. This publication is protected under the Copyright laws of Denmark and most other countries.

Danfoss does not warrant that a software program produced according to the guidelines provided in this manual will function properly in every physical, hardware or software environment.

Although Danfoss has tested and reviewed the documentation within this manual, Danfoss makes no warranty or representation, neither expressed nor implied, with respect to this documentation, including its quality, performance, or fitness for a particular purpose.

In no event shall Danfoss be liable for direct, indirect, special, incidental, or consequential damages arising out of the use, or the inability to use information contained in this manual, even if advised of the possibility of such damages. In particular, Danfoss is not responsible for any costs, including but not limited to those incurred as a result of lost profits or revenue, loss or damage of equipment, loss of computer programs, loss of data, the costs to substitute these, or any claims by third parties.

Danfoss reserves the right to revise this publication at any time and to make changes to its contents without prior notice or any obligation to notify former or present users of such revisions or changes.

### 1.1.2 Symbols

Symbols used in this guide.

#### NOTE

Indicates something to be noted by the reader.

#### **CAUTION**

Indicates a potentially hazardous situation which, if not avoided, may result in minor or moderate injury or equipment damage.

#### **WARNING**

Indicates a potentially hazardous situation which, if not avoided, could result in death or serious injury.

\* Indicates default setting

### 1.1.3 Abbreviations

Alternating current	AC
American wire gauge	AWG
Ampere/AMP	A
Automatic Motor Adaptation	AMA
Current limit	I <sub>LIM</sub>
Degrees Celsius	°C
Direct current	DC
Drive Dependent	D-TYPE
Electro Magnetic Compatibility	EMC
Electronic Thermal Relay	ETR
Frequency Converter	FC
Gram	g
Hertz	Hz
Horsepower	hp
Kilohertz	kHz
Local Control Panel	LCP
Meter	m
Millihenry Inductance	mH
Milliamper	mA
Millisecond	ms
Minute	min
Motion Control Tool	MCT
Nanofarad	nF
Newton Meters	Nm
Nominal motor current	I <sub>M,N</sub>
Nominal motor frequency	f <sub>M,N</sub>
Nominal motor power	P <sub>M,N</sub>
Nominal motor voltage	U <sub>M,N</sub>
Parameter	par.
Protective Extra Low Voltage	PELV
Printed Circuit Board	PCB
Rated Inverter Output Current	I <sub>INV</sub>
Revolutions Per Minute	RPM
Regenerative terminals	Regen
Second	s
Synchronous Motor Speed	n <sub>s</sub>
Torque limit	T <sub>LIM</sub>
Volts	V
The maximum output current	I <sub>VLT,MAX</sub>
The rated output current supplied by the frequency converter	I <sub>VLT,N</sub>

### 1.1.4 Available Literature for VLT HVAC Basic Drive

- Quick Guide MG.18.Ax.yy
- Programming Guide MG.18.Bx.yy provides information on how to programme and includes complete parameter descriptions.
- Design Guide MG.18.Cx.yy entails all technical information about the frequency converter and customer design and applications.
- PC-based Configuration Tool MCT-10, MG.10.Ax.yy enables the user to configure the frequency converter from a Windows™ based PC environment.
- Danfoss VLT® Energy Box software at [www.danfoss.com/BusinessAreas/DrivesSolutions](http://www.danfoss.com/BusinessAreas/DrivesSolutions) then choose PC Software Download VLT® Energy Box Software allows energy consumption comparisons of HVAC fans and pumps driven by Danfoss drives and alternative methods of flow control. This tool may be used to project, as accurately as possible, the costs, savings, and payback of using Danfoss drives on HVAC fans and pumps.

x = Revision number  
yy = Language code

Danfoss technical literature is available in print from your local Danfoss Sales Office or online at:  
[www.danfoss.com/BusinessAreas/DrivesSolutions/Documentations/Technical+Documentation.htm](http://www.danfoss.com/BusinessAreas/DrivesSolutions/Documentations/Technical+Documentation.htm)

### 1.1.5 Definitions

**Frequency converter:**

$I_{VLT,MAX}$   
Maximum output current.

$I_{VLT,N}$   
Rated output current supplied by the frequency converter.

$U_{VLT, MAX}$   
Maximum output voltage.

**Input:**

Control command

Start and stop the connected motor by means of LCP and digital inputs.

Functions are divided into two groups.

Functions in group 1 have higher priority than functions in group 2.

Group 1	Reset, Coasting stop, Reset and Coasting stop, Quick-stop, DC braking, Stop and the [OFF] key.
Group 2	Start, Latched start, Reversing, Start reversing, Jog and Freeze output

**Motor:**

Motor Running

Torque generated on output shaft and speed from zero rpm to max. speed on motor.

$f_{JOG}$   
Motor frequency when the jog function is activated (via digital terminals).

$f_M$   
Motor frequency.

$f_{MAX}$   
Maximum motor frequency.

$f_{MIN}$   
Minimum motor frequency.

$f_{M,N}$   
Rated motor frequency (nameplate data).

$I_M$   
Motor current (actual).

$I_{M,N}$   
Rated motor current (nameplate data).

$n_{M,N}$   
Rated motor speed (nameplate data).

$n_s$   
Synchronous motor speed

$$n_s = \frac{2 \times par. 1 - 23 \times 60 s}{par. 1 - 39}$$

$P_{M,N}$   
Rated motor power (nameplate data in kW or hp).

$T_{M,N}$   
Rated torque (motor).

$U_M$   
Instantaneous motor voltage.

$U_{M,N}$   
Rated motor voltage (nameplate data).

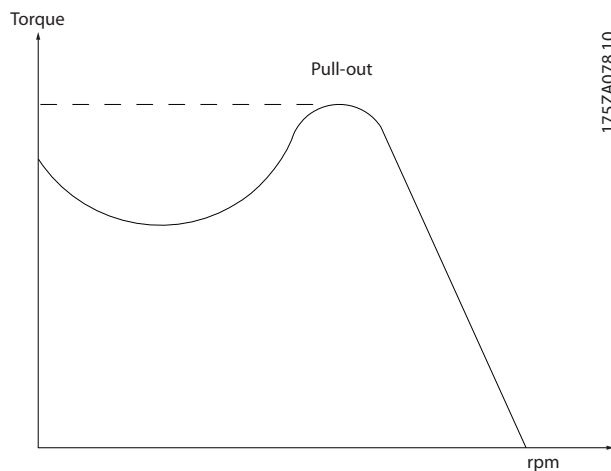

Break-away torque $\eta_{VLT}$ 

The efficiency of the frequency converter is defined as the ratio between the power output and the power input.

Start-disable command

A stop command belonging to the group 1 control commands - see this group.

Stop command

See Control commands.

**References:**Analog Reference

A signal transmitted to the analog inputs 53 or 54, can be voltage or current.

Binary Reference

A signal transmitted to the serial communication port.

Preset Reference

A defined preset reference to be set from -100% to +100% of the reference range. Selection of eight preset references via the digital terminals.

Ref<sub>MAX</sub>

Determines the relationship between the reference input at 100% full scale value (typically 10 V, 20mA) and the resulting reference. The maximum reference value set in 3-03 *Maximum Reference*.

Ref<sub>MIN</sub>

Determines the relationship between the reference input at 0% value (typically 0V, 0mA, 4mA) and the resulting reference. The minimum reference value set in 3-02 *Minimum Reference*.

**Miscellaneous:**Analog Inputs

The analog inputs are used for controlling various functions of the frequency converter.

There are two types of analog inputs:

Current input, 0-20mA and 4-20mA

Voltage input, 0-10V

Analog Outputs

The analog outputs can supply a signal of 0-20mA, 4-20mA.

Automatic Motor Adaptation, AMA

AMA algorithm determines the electrical parameters for the connected motor at standstill.

CTW

Control Word

Digital Inputs

The digital inputs can be used for controlling various functions of the frequency converter.

ETR

Electronic Thermal Relay is a thermal load calculation based on present load and time. Its purpose is to estimate the motor or frequency converter temperature.

Initialising

If initialising is carried out (*14-22 Operation Mode*), the frequency converter returns to the default setting.

Intermittent Duty Cycle

An intermittent duty rating refers to a sequence of duty cycles. Each cycle consists of an on-load and an off-load period. The operation can be either periodic duty or non-periodic duty.

LCP

The Local Control Panel makes up a complete interface for control and programming of the frequency converter. The control panel is detachable and can be installed up to 3 metres from the frequency converter, i.e. in a front panel by means of the installation kit option.

lsb

Least significant bit.

msb

Most significant bit.

MCM

Short for Mille Circular Mil, an American measuring unit for cable cross-section. 1 MCM = 0.5067mm<sup>2</sup>.

Process PI

The PI control maintains the desired speed, pressure, temperature, etc. by adjusting the output frequency to match the varying load.

Power Cycle

Switch off the mains until display (LCP) is dark – then turn power on again.

RCD

Residual Current Device.

### Set-up

You can save parameter settings in two Set-ups. Change between the two parameter Set-ups and edit one Set-up, while another Set-up is active.

### Slip Compensation

The frequency converter compensates for the motor slip by giving the frequency a supplement that follows the measured motor load keeping the motor speed almost constant.

Slip compensation is default set to off.

### Smart Logic Control (SLC)

The SLC is a sequence of user defined actions executed when the associated user defined events are evaluated as true by the Smart Logic Controller. (Par. group 13-\*\* [Smart Logic Control \(SLC\)](#).)

### STW

Status Word

### FC Standard Bus

Includes RS-485 bus with FC protocol. See *8-30 Protocol*.

### Thermistor

A temperature-dependent resistor placed where the temperature is to be monitored (frequency converter or motor).

### Trip

A state entered in fault situations, e.g. if the frequency converter is subject to an over-temperature or when the frequency converter is protecting the motor, process or mechanism. Restart is prevented until the cause of the fault has disappeared and the trip state is cancelled by activating reset or, in some cases, by being programmed to reset automatically. Trip may not be used for personal safety.

### Trip Lock

A state entered in fault situations when the frequency converter is protecting itself and requiring physical intervention, e.g. if the frequency converter is subject to a short circuit on the output. A locked trip can only be cancelled by cutting off mains, removing the cause of the fault, and reconnecting the frequency converter. Restart is prevented until the trip state is cancelled by activating reset or, in some cases, by being programmed to reset automatically. Trip may not be used for personal safety.

### VT Characteristics

Variable torque characteristics used for pumps and fans.

### VVC<sup>plus</sup>

If compared with standard voltage/frequency ratio control, Voltage Vector Control (VVC<sup>plus</sup>) improves the dynamics and the stability, both when the speed reference is changed and in relation to the load torque.

### Power Factor

The power factor is the relation between  $I_1$  and  $I_{RMS}$ .

$$\text{Power factor} = \frac{\sqrt{3} \times U \times I_1 \cos\varphi}{\sqrt{3} \times U \times I_{RMS}}$$

The power factor for 3-phase control:

$$= \frac{I_1 \times \cos\varphi}{I_{RMS}} = \frac{I_1}{I_{RMS}} \text{ since } \cos\varphi = 1$$

The power factor indicates to which extent the frequency converter imposes a load on the mains supply.

The lower the power factor, the higher the  $I_{RMS}$  for the same kW performance.

$$I_{RMS} = \sqrt{I_1^2 + I_5^2 + I_7^2 + \dots + I_n^2}$$

In addition, a high power factor indicates that the different harmonic currents are low.

The frequency converters' built-in DC coils produce a high power factor, which minimizes the imposed load on the mains supply.

## WARNING

**The voltage of the frequency converter is dangerous whenever connected to mains. Incorrect installation of the motor, frequency converter or fieldbus may cause death, serious personal injury or damage to the equipment. Consequently, the instructions in this manual, as well as national and local rules and safety regulations, must be complied with.**

### Safety Regulations

1. The mains supply to the frequency converter must be disconnected whenever repair work is to be carried out. Check that the mains supply has been disconnected and that the necessary time has elapsed before removing motor and mains supply plugs.
2. The [OFF] button on the control panel of the frequency converter does not disconnect the mains supply and consequently it must not be used as a safety switch.
3. The equipment must be properly earthed, the user must be protected against supply voltage and the motor must be protected against overload in accordance with applicable national and local regulations.
4. The earth leakage current exceeds 3.5mA.
5. Protection against motor overload is not included in the factory setting. If this function is desired, set *1-90 Motor Thermal Protection* to data value ETR trip 1 [4] or data value ETR warning 1 [3].
6. Do not remove the plugs for the motor and mains supply while the frequency converter is connected to mains. Check that the mains supply has been disconnected and that the necessary time has elapsed before removing motor and mains plugs.
7. Please note that the frequency converter has more voltage sources than L1, L2 and L3, when load

sharing (linking of DC intermediate circuit) or external 24V DC are installed. Check that all voltage sources have been disconnected and that the necessary time has elapsed before commencing repair work.

#### Warning against unintended start

1. The motor can be brought to a stop by means of digital commands, bus commands, references or a local stop, while the frequency converter is connected to mains. If personal safety considerations (e.g. risk of personal injury caused by contact with moving machine parts following an unintentional start) make it necessary to ensure that no unintended start occurs, these stop functions are not sufficient. In such cases the mains supply must be disconnected.
2. The motor may start while setting the parameters. If this means that personal safety may be compromised (e.g. personal injury caused by contact with moving machine parts), motor starting must be prevented, for instance by secure disconnection of the motor connection.
3. A motor that has been stopped with the mains supply connected, may start if faults occur in the electronics of the frequency converter, through temporary overload or if a fault in the power supply grid or motor connection is remedied. If unintended start must be prevented for personal safety reasons (e.g. risk of injury caused by contact with moving machine parts), the normal stop functions of the frequency converter are not sufficient.
4. Control signals from, or internally within, the frequency converter may in rare cases be activated

in error, be delayed or fail to occur entirely. When used in situations where safety is critical, these control signals must not be relied on exclusively.

### **⚠ WARNING**

#### High Voltage

**Touching the electrical parts may be fatal - even after the equipment has been disconnected from mains.**

**Also make sure that other voltage inputs have been disconnected, such as load sharing (linkage of DC intermediate circuit)**

**Systems where frequency converters are installed must, if necessary, be equipped with additional monitoring and protective devices according to the valid safety regulations, e.g. law on mechanical tools, regulations for the prevention of accidents etc. Modifications on the frequency converters by means of the operating software are allowed.**

#### NOTE

**Hazardous situations shall be identified by the machine builder/ integrator who is responsible for taking necessary preventive means into consideration. Additional monitoring and protective devices may be included, always according to valid national safety regulations, e.g. law on mechanical tools, regulations for the prevention of accidents.**

#### Protection Mode

Once a hardware limit on motor current or dc-link voltage is exceeded the frequency converter will enter *Protection mode*. *Protection mode* means a change of the PWM modulation strategy and a low switching frequency to minimize losses. This continues 10 sec after the last fault and increases the reliability and the robustness of the frequency converter while re-establishing full control of the motor. Parameter *0-07 Auto DC Braking IT* may cause PWM when coasted.

1.1.6 Electrical Overview

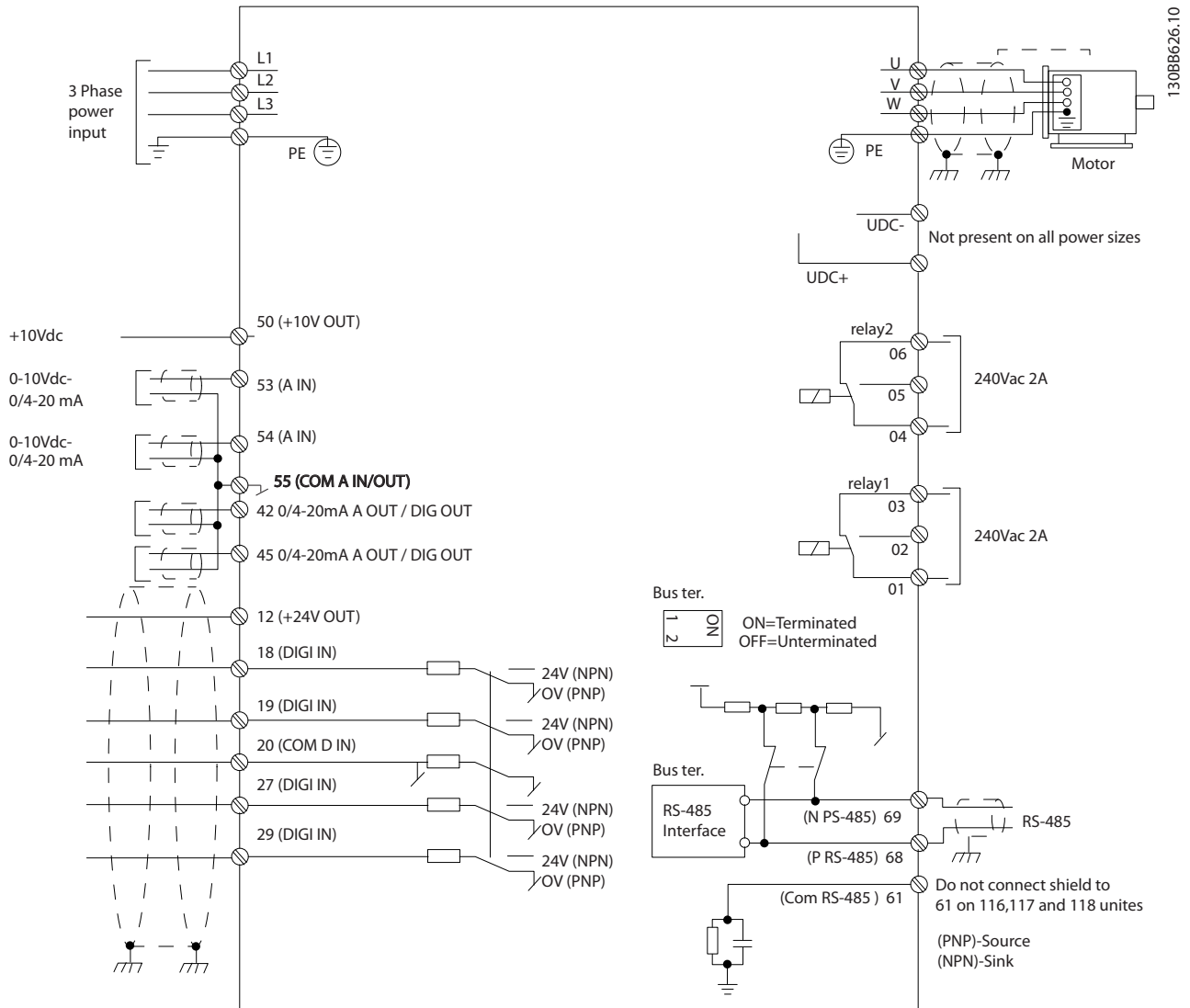

**NOTE**

Please note there is no access to UDC- and UDC+ on the following units:  
 IP20 380-480V 30-90kW

## 2 How to Programme

# 2

### 2.1 Programming with MCT-10 Setup software

The frequency converter can be programmed from a PC via RS-485 COM port by installing the MCT-10 Setup software. This software can either be ordered using code number 130B1000 or downloaded from the Danfoss Web site: <http://www.danfoss.com/BusinessAreas/DrivesSolutions/Software-download/> Please refer to manual MG.10.RX.YY.

### 2.2 Local Control Panel (LCP)

The following instructions are valid for the FC101 LCP. The LCP is divided into four functional sections:

- A. Alphanumeric display.
- B. Menu key.
- C. Navigation keys and indicator lights (LEDs).
- D. Operation keys and indicator lights (LEDs).

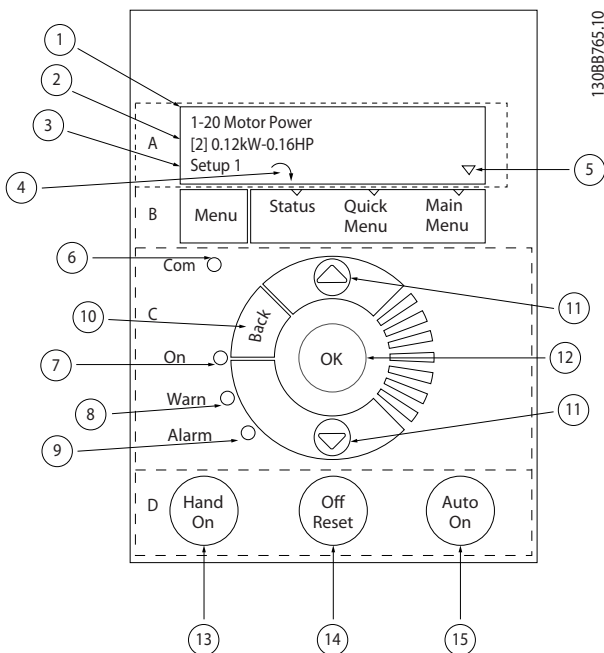

#### A. Alpha Numeric Display

The LCD-display is back-lit with 2 alpha-numeric lines. All data is displayed on the LCP.

A number of information can be read from the display:

1	Parameter number and name.
2	Parameter value.
3	Set-up number shows the active set-up and the edit set-up. If the same set-up acts as both active and edit set-up, only that set-up number is shown (factory setting). When active and edit set-up differ, both numbers are shown in the display (Setup 12). The number flashing, indicates the edit set-up.
4	Motor direction is shown to the bottom left of the display – indicated by a small arrow pointing either clockwise or counterclockwise.
5	The triangle indicates if the LCP is in status, quick menu or main menu.

#### B. Menu Key

Use the menu key to select between status, quick menu or main menu.

#### C. Navigation keys and indicator lights (LEDs)

6	Com led: Flashes when bus communication is communicating.
7	Green LED/On: Control section is working.
8	Yellow LED/Warn.: Indicates a warning.
9	Flashing Red LED/Alarm: Indicates an alarm.
10	[Back]: For moving to the previous step or layer in the navigation structure
11	Arrows [▲] [▼]: For maneuvering between parameter groups, parameters and within parameters. Can also be used for setting local reference.
12	[OK]: For selecting a parameter and for accepting changes to parameter settings

#### D. Operation keys and indicator lights (LEDs)

13	[Hand on]: Starts the motor and enables control of the frequency converter via the LCP. <b>NOTE</b> Please note that terminal 27 Digital Input (5-12 Terminal 27 Digital Input) has coast inverse as default setting. This means that [Hand On] will not start the motor if there is no 24V to terminal 27, so please connect terminal 12 to terminal 27.
14	[Off/Reset]: Stops the motor (off). If in alarm mode the alarm will be reset.
15	[Auto on]: Frequency converter is controlled either via control terminals or serial communication.

**At power-up**

At the first power-up the user is asked to choose preferred language. Once selected this screen will never be shown again in the following powerups, but language can still be changed in *0-01 Language*.

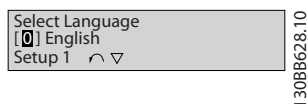

**2.3 Menus**

**2.3.1 Status**

When choosing the [Status] menu it is possible to choose between the following:

- Motor Frequency (Hz), par. 16-13;
- Motor Current (A), par. 16-14;
- Motor Speed Reference in Percentage (%), par. 16-02;
- Feedback, par. 16-52;
- Motor Power (kW) (if *0-03 Regional Settings* is set to [1] North America, Motor Power will be shown in the unit of hp instead of kW), par. 16-10 for kW, par. 16-11 for hp;
- Custom Readout par. 16-09;

**2.3.2 Quick Menu**

Allows quick setup of the frequency converter. The most common VLT HVAC Basic Drive functions can be programmed here: The [Quick Menu] consists of:

- Wizard for open loop applications
- Closed loop set-up wizard
- Motor set-up
- Changes made

**2.3.3 The FC101 Start-up Wizard for Open Loop Applications**

The built in *wizard* menu guides the installer through the set up of the frequency converter in a clear and structured manner in order to setup an open loop application. A open loop application is here an application with a start signal, analog reference (voltage or current) and optionally also relay signals (but no feed back signal from the process applied).

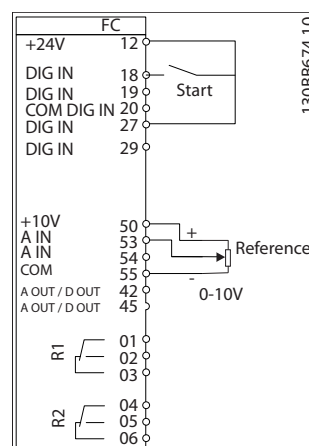

The wizard will initially be shown after power up until any parameter has been changed. The wizard can always be accessed again through the quick menu. Press [OK] to start the wizard. If [BACK] is pressed, the FC101 will return to the status screen.

The wizard will initially start up after power up until a parameter has been changed. The wizard can always be accessed again through the quick menu. Press [OK] to start the wizard. If *Cancel* is pressed, the FC101 will return to the status screen.

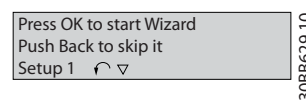

2

At power up the user is asked to choose the preferred language.

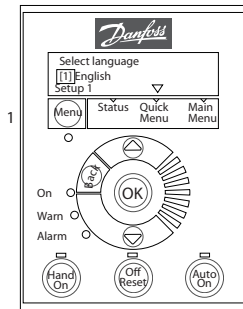

Power Up Screen



The next screen will be the Wizard screen.

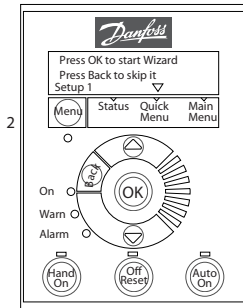

Wizard Screen

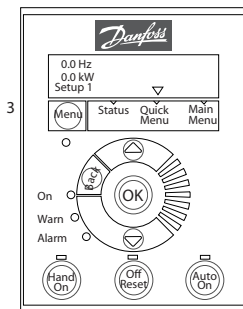

Status Screen

The Wizard can always be reentered via the Quick Menu!

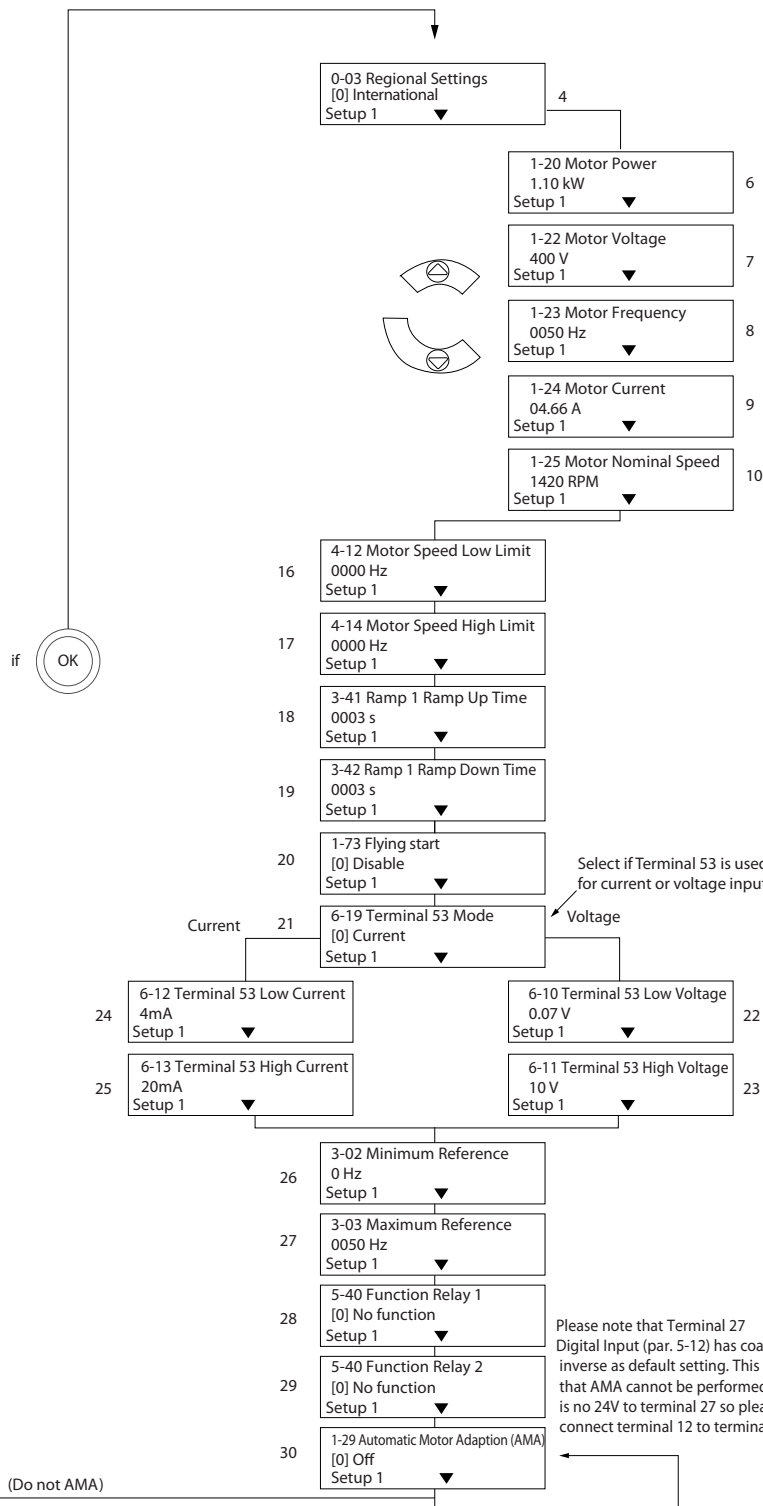
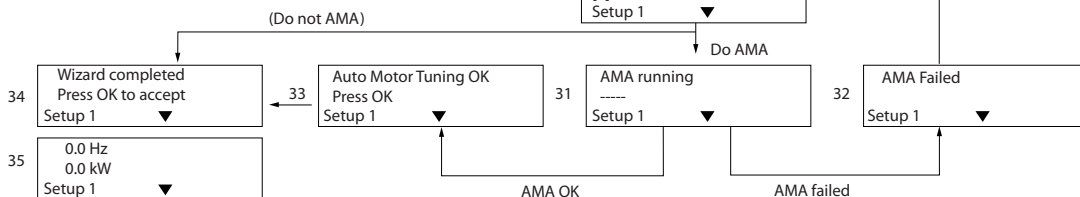

13088630.10

**The FC101 Start-up Wizard for Open Loop Applications**

No & Name	Range	Default	Function
0-03 <i>Regional Settings</i>	[0] International [1] US	0	
1-20 <i>Motor Power</i>	0.12-110kW/0.16-150hp	Size related	Enter motor power from nameplate data
1-22 <i>Motor Voltage</i>	50.0 - 1000.0V	Size related	Enter motor voltage from nameplate data
1-23 <i>Motor Frequency</i>	20.0 - 400.0Hz	Size related	Enter motor frequency from nameplate data
1-24 <i>Motor Current</i>	0.01 - 10000.00A	Size related	Enter motor current from nameplate data
1-25 <i>Motor Nominal Speed</i>	100.0 - 9999.0 RPM	Size related	Enter motor nominal speed from nameplate data
4-12 <i>Motor Speed Low Limit [Hz]</i>	0.0 - 400 Hz	0 Hz	Enter the minimum limit for low speed
4-14 <i>Motor Speed High Limit [Hz]</i>	0.0 - 400 Hz	65 Hz	Enter the maximum limit for high speed
3-41 <i>Ramp 1 Ramp up Time</i>	0.05 - 3600.0 s	Size related	Ramp up time from 0 to rated motor frequency par. 1-23
3-42 <i>Ramp 1 Ramp Down Time</i>	0.05 - 3600.0 s	Size related	Ramp down time from rated motor frequency par. 1-23 to 0
1-73 <i>Flying Start</i>	[0] Disabled [1] Enabled	0	Select Enable to enable the frequency converter to catch a spinning motor i.e. fan applications
6-19 <i>Terminal 53 mode</i>	[0] Current [1] Voltage	1	Select if terminal 53 is used for current- or voltage input
6-10 <i>Terminal 53 Low Voltage</i>	0-10V	0.07V	Enter the voltage that corresponds to the low reference value
6-11 <i>Terminal 53 High Voltage</i>	0-10V	10V	Enter the voltage that corresponds to the high reference value
6-12 <i>Terminal 53 Low Current</i>	0-20mA	4	Enter the current that corresponds to the low reference value
6-13 <i>Terminal 53 High Current</i>	0-20mA	20	Enter the current that corresponds to the high reference value
3-02 <i>Minimum Reference</i>	-4999-4999	0	The minimum reference is the lowest value obtainable by summing all references
3-03 <i>Maximum Reference</i>	-4999-4999	50	The maximum reference is the lowest obtainable by summing all references
5-40 <i>Function Relay [0] Function relay</i>	See 5-40 <i>Function Relay</i>	Alarm	Select the function to control output relay 1
5-40 <i>Function Relay [1] Function relay</i>	See 5-40 <i>Function Relay</i>	Drive running	Select the function to control output relay 2
1-29 <i>Automatic Motor Adaption (AMA)</i>	See 1-29 <i>Automatic Motor Adaption (AMA)</i>	Off	Performing an AMA optimizes motor performance



Closed Loop Set-up Wizard

2

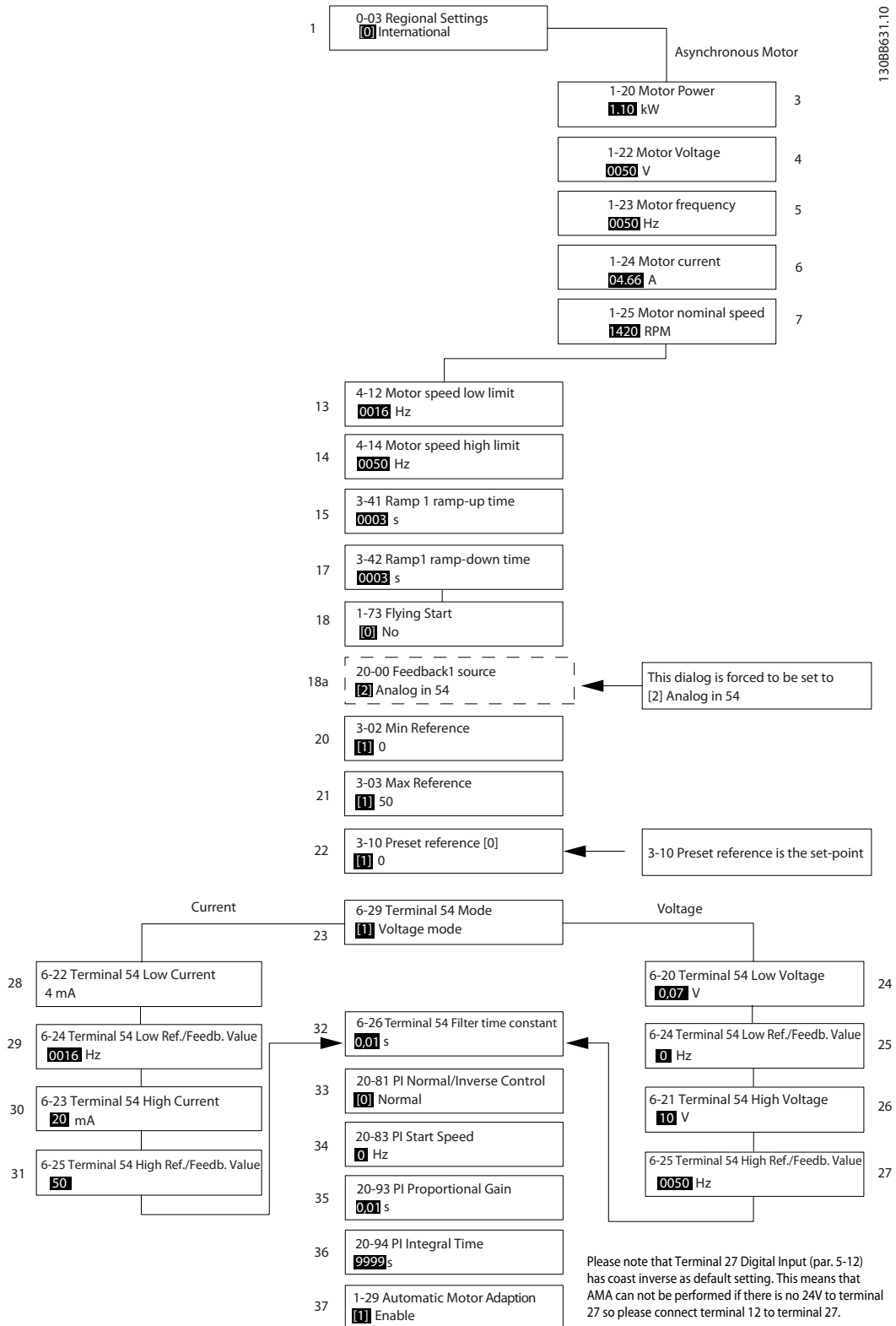

13088631.10

## Closed Loop Set-up Wizard

No & Name	Range	Default	Function
0-03 <i>Regional Settings</i>	[0] International [1] US	0	
1-20 <i>Motor Power</i>	0.09-110kW	Size related	Enter motor power from nameplate data
1-22 <i>Motor Voltage</i>	50.0 - 1000.0V	Size related	Enter motor voltage from nameplate data
1-23 <i>Motor Frequency</i>	20.0 - 400.0Hz	Size related	Enter motor frequency from nameplate data
1-24 <i>Motor Current</i>	0.01 - 10000.00A	Size related	Enter motor current from nameplate data
1-25 <i>Motor Nominal Speed</i>	100.0 - 9999.0RPM	Size related	Enter motor nominal speed from nameplate data
4-12 <i>Motor Speed Low Limit [Hz]</i>	0 - 400Hz	0.0Hz	Enter the minimum limit for low speed
4-14 <i>Motor Speed High Limit [Hz]</i>	0 - 400Hz	65Hz	Enter the maximum limit for high speed
3-41 <i>Ramp 1 Ramp up Time</i>	0.05 - 3600.0 s	Size related	Ramp up time from 0 to rated motor frequency par. 1-23
3-42 <i>Ramp 1 Ramp Down Time</i>	0.05 - 3600.0 s	Size related	Ramp down time from rated 1-23 <i>Motor Frequency</i> to 0
1-73 <i>Flying Start</i>	[0] Disabled [1] Enabled	0	Select Enable to enable the frequency converter to catch a spinning motor
3-02 <i>Minimum Reference</i>	-4999-4999	0	The minimum reference is the lowest value obtainable by summing all references
3-03 <i>Maximum Reference</i>	-4999-4999	50	The maximum reference is the highest value obtainable by summing all references
3-10 <i>Preset Reference</i>	-100-100%	0	Enter the set point
6-19 <i>Terminal 53 mode</i>	[0] Current [1] Voltage	1	Select if terminal 53 is used for current- or voltage input
6-10 <i>Terminal 53 Low Voltage</i>	0-10V	0.07V	Enter the voltage that corresponds to the low reference value
6-11 <i>Terminal 53 High Voltage</i>	0-10V	10V	Enter the voltage that corresponds to the low high reference value
6-12 <i>Terminal 53 Low Current</i>	0-20mA	4	Enter the current that corresponds to the high reference value
6-13 <i>Terminal 53 High Current</i>	0-20mA	20	Enter the current that corresponds to the high reference value
6-14 <i>Terminal 53 Low Ref./Feedb. Value</i>	-4999-4999	0	Enter the feedback value that corresponds to the voltage or current set in par. 6-10/6-12
6-15 <i>Terminal 53 High Ref./Feedb. Value</i>	-4999-4999	50	Enter the feedback value that corresponds to the voltage or current set in par. 6-11/6-13
6-16 <i>Terminal 53 Filter Time Constant</i>	0-10 s	0.01	Enter the filter time constant
20-81 <i>PI Normal/ Inverse Control</i>	[0] Normal [1] Inverse	0	Select <i>Normal</i> [0] to set the process control to increase the output speed when the process error is positive. Select <i>Inverse</i> [1] to reduce the output speed.
20-83 <i>PI Start Speed [Hz]</i>	0-200Hz	0	Enter the motor speed to be attained as a start signal for commencement of PI control
20-93 <i>PI Proportional Gain</i>	0-10	0.01	Enter the process controller proportional gain. Quick control is obtained at high amplification. However if amplification is too great, the process may become unstable
1-29 <i>Automatic Motor Adaption (AMA)</i>	See 1-29 <i>Automatic Motor Adaption (AMA)</i>	Off	Performing an AMA optimizes motor performance

### Motor Set-up

The Quick Menu Motor Set-up guides through the needed motor parameters.

No & Name	Range	Default	Function
0-03 <i>Regional Settings</i>	[0] International [1] US	0	
1-20 <i>Motor Power</i>	0.12-110kW/ 0.16-150hp	Size related	Enter motor power from nameplate data
1-22 <i>Motor Voltage</i>	50.0 - 1000.0V	Size related	Enter motor voltage from nameplate data
1-23 <i>Motor Frequency</i>	20.0 - 400.0Hz	Size related	Enter motor frequency from nameplate data
1-24 <i>Motor Current</i>	0.01 - 10000.00A	Size related	Enter motor current from nameplate data
1-25 <i>Motor Nominal Speed</i>	100.0 - 9999.0 RPM	Size related	Enter motor nominal speed from nameplate data
4-12 <i>Motor Speed Low Limit [Hz]</i>	0.0 - 400Hz	0.0Hz	Enter the minimum limit for low speed
4-14 <i>Motor Speed High Limit [Hz]</i>	0.0 - 400HZ	65	
3-41 <i>Ramp 1 Ramp up Time</i>	0.05 - 3600.0 s	Size related	Ramp up time from 0 to rated <i>1-23 Motor Frequency</i>
3-42 <i>Ramp 1 Ramp Down Time</i>	0.05 - 3600.0 s	Size related	Ramp down time from rated <i>1-23 Motor Frequency</i> to 0
1-73 <i>Flying Start</i>	[0] Disabled [1] Enabled	0	Select Enable to enable the frequency converter to catch a spinning motor

### Changes Made

Changes Made lists all parameters changed since factory setting. Only the changed parameters in current edit-setup are listed in changes made.

If the parameter's value is changed back to factory setting's value from another different value, the parameter will NOT be listed in Changes Made.

1. Press [MENU] key to enter the Quick Menu until indicator in display is placed above Quick Menu.
2. Press [▲] [▼] to select either FC101 wizard, closed loop setup, motor setup or changes made, then press [OK].
3. Press [▲] [▼] to browse through the parameters in the Quick Menu.
4. Press [OK] to select a parameter.
5. Press [▲] [▼] to change the value of a parameter setting.
6. Press [OK] to accept the change.
7. Press either [Back] twice to enter "Status", or press [Menu] once to enter "Main Menu".

### 2.3.4 Main Menu

[Main Menu] is used for programming all parameters. The Main Menu parameters can be accessed immediately unless a password has been created via *0-60 Main Menu Password*. For the majority of VLT HVAC Basic Drive applications it is not necessary to access the Main Menu parameters but instead the Quick Menu provides the simplest and quickest access to the typical required parameters.

The Main Menu accesses all parameters.

1. Press [MENU] key until indicator in display is placed above "Main Menu".
2. Use [▲] [▼] to browse through the parameter groups.
3. Press [OK] to select a parameter group.
4. Use [▲] [▼] to browse through the parameters in the specific group.
5. Press [OK] to select the parameter.
6. Use [▲] [▼] to set/change the parameter value.

[BACK] is used to go one level back.

## 2.4 Quick Transfer of Parameter Settings between Multiple Frequency Converters

Once the set-up of a frequency converter is complete, Danfoss recommends that you store the data in the LCP or on a PC via MCT-10 Setup software tool.

Data storage in LCP:

1. Go to *0-50 LCP Copy*
2. Press the [OK] key
3. Select "All to LCP"
4. Press the [OK] key

### **⚠ WARNING**

**Stop the motor before performing this operation.**

You can now connect the LCP to another frequency converter and copy the parameter settings to this frequency converter as well.

Data transfer from LCP to frequency converter:

1. Go to *0-50 LCP Copy*
2. Press the [OK] key
3. Select "All from LCP"
4. Press the [OK] key

### **NOTE**

**Stop the motor before performing this operation.**

## 2.5 Read-out and Programming of Indexed Parameters

Use *par. 3-10 Preset Reference* as an example:  
Choose the parameter, press [OK], and use the up/down navigation keys to scroll through the indexed values. To change the parameter value, select the indexed value and press [OK]. Change the value by using the up/down keys. Press [OK] to accept the new setting. Press [CANCEL] to abort. Press [Back] to leave the parameter.

## 2.6 Initialise the Frequency Converter to Default Settings in two Ways

Recommended initialisation (via *14-22 Operation Mode*)

1. Select *14-22 Operation Mode*.
2. Press [OK].
3. Select *Initialisation* and Press [OK].
4. Cut off the mains supply and wait until the display turns off.
5. Reconnect the mains supply - the frequency converter is now reset. *Except the following parameters.*

*8-30 Protocol*

*8-31 Address*

*8-32 Baud Rate*

*8-33 Parity / Stop Bits*

*8-35 Minimum Response Delay*

*8-36 Maximum Response Delay*

*8-37 Maximum Inter-char delay*

*8-70 BACnet Device Instance*

*8-72 MS/TP Max Masters*

*8-73 MS/TP Max Info Frames*

*8-74 "I am" Service*

*8-75 Intialisation Password*

*15-00 Operating Hours to 15-05 Over Volt's*

*15-03 Power Up's*

*15-04 Over Temp's*

*15-05 Over Volt's*

*15-30 Alarm Log: Error Code*

*15-4\* Drive identification parameters*

### **Two finger initialization:**

1. Power off the frequency converter.
2. Press [OK] and [MENU].
3. Power up the frequency converter while still pressing the keys above for 10s.
4. The frequency converter is now reset, except the following parameters:

*15-00 Operating Hours*

*15-03 Power Up's*

*15-04 Over Temp's*

*15-05 Over Volt's*

*15-4\* Drive identification parameters*

Initialisation of parameters is conformed by AL80 in the display after the power cycle.

## 3 Parameters

### 3

### 3.1 Main Menu - Operation and Display - Group 0

Parameters related to the fundamental functions of the frequency converter, function of the LCP buttons and configuration of the LCP display.

#### 3.1.1 0-0\* Basic Settings

0-01 Language		
Option:	Function:	
		Defines the language to be used in the display.
[0] *	English	
[1]	Deutsch	
[2]	Francais	
[3]	Dansk	
[4]	Spanish	
[5]	Italiano	
[28]	Bras.port	
[255]	No Text	

0-03 Regional Settings		
Option:	Function:	
		This parameter cannot be adjusted while the motor is running. In order to meet the needs for different default settings in different parts of the world, <i>0-03 Regional Settings</i> is implemented in the frequency converter. The selected setting influences the default setting of the motor nominal frequency.
[0] *	International	Sets default value of <i>1-23 Motor Frequency</i> [50Hz].
[1]	North America	Sets the default value of <i>1-23 Motor Frequency</i> to 60Hz.

0-04 Operating State at Power-up		
Option:	Function:	
		Select the operating mode upon reconnection of the frequency converter to mains voltage after power down when operating in Hand (local) mode.
[0] *	Resume	Resumes operation of the frequency converter maintaining the same local reference and the same start/stop condition (applied by [Hand On]/[Off] on the LCP or Hand Start via a digital input as before the frequency converter was powered down.

0-04 Operating State at Power-up		
Option:	Function:	
[1]	Forced stop, ref=old	Uses saved reference [1] to stop the frequency converter but at the same time retain the local speed reference in memory prior to power down. After mains voltage is reconnected and after receiving a start command (using the LCP [Hand On] button or Hand Start command via a digital input) the frequency converter restarts and operates at the retained speed reference.

0-06 GridType		
Option:	Function:	
		Select the grid type of the supply voltage/frequency. <b>NOTE</b> <b>Not all choices are supported in all power sizes.</b>  IT grid is a supply mains, where there are no connections to ground.  Delta is a supply mains where the secondary part of the transformer is delta connected and one phase is connected to ground.
[0]	200-240V/50Hz/IT-grid	
[1]	200-240V/50Hz/Delta	
[2]	200-240V/50Hz	
[10]	380-440V/50Hz/IT-grid	
[11]	380-440V/50Hz/Delta	
[12]	380-440V/50Hz	
[20]	440-480V/50Hz/IT-grid	
[21]	440-480V/50Hz/Delta	
[22]	440-480V/50Hz	
[30]	525-600V/50Hz/IT-grid	
[31]	525-600V/50Hz/Delta	
[32]	525-600V/50Hz	
[100]	200-240V/60Hz/IT-grid	
[101]	200-240V/60Hz/Delta	
[102]	200-240V/60Hz	
[110]	380-440V/60Hz/IT-grid	
[111]	380-440V/60Hz/Delta	
[112]	380-440V/60Hz	

0-06 GridType	
Option:	Function:
[120]	440-480V/60Hz/IT-grid
[121]	440-480V/60Hz/Delta
[122]	440-480V/60Hz
[130]	525-600V/60Hz/IT-grid
[131]	525-600V/60Hz/Delta
[132]	525-600V/60Hz

0-07 Auto DC Braking IT	
Option:	Function:
	Protective function against overvoltage at coast. <div style="border: 1px solid black; padding: 5px; display: inline-block;"> <b>⚠ WARNING</b>                      Can cause PWM when coasted.                 </div>
[0]	Off Function is not active.

0-10 Active Set-up	
Option:	Function:
	Select the set-up in which the frequency converter is to operate. Use <i>0-51 Set-up Copy</i> to copy a set-up to one or all other set-ups. To avoid conflicting settings of the same parameter within two different set-ups, link the set-ups together using <i>0-12 Link Setups</i> . Stop the frequency converter before switching between set-ups where parameters marked 'not changeable during operation' have different values. Parameters which are 'not changeable during operation' are marked FALSE in the parameter lists in the section <i>Parameter Lists</i> .
[1] *	Set-up 1 Set-up 1 is active.
[2]	Set-up 2 Set-up 2 is active.
[9]	Multi Set-up Is used for remote selection of set-ups using digital inputs and the serial communication port. This set-up uses the settings from <i>0-12 Link Setups</i> .

### 3.1.2 0-1\* Define and set-up Operations

Define and control the individual parameter set-ups. User defined parameters and miscellaneous external inputs (e.g. bus, LCP, analog/digital inputs, feedback, etc.) controls the functionality of the frequency converter.

A complete set of all parameters controlling the frequency converter is called a set-up. The frequency converter contains 2 set-ups, Set-up1 and Set-up2. Furthermore, a fixed set of factory settings can be copied into one or more set-ups.

Some of the advantages of having more than one set-up in the frequency converter are:

- Run motor in one set-up (Active Set-up) while updating parameters in another set-up (Edit Set-up)
- Connect various motors (one at a time) to frequency converter. Motor data for various motors can be placed in different set-ups.
- Rapidly change settings of frequency converter and/or motor while motor is running e.g.. Ramp time or preset references) via bus or digital inputs.

The Active Set-up can be set as Multi Set-up where the active set-up is selected via input on a digital input terminal and/or via the bus control word.

0-11 Programming Set-up	
Option:	Function:
	Select the set-up to be edited (i.e. programmed) during operation; either the active set-up or the inactive set-up. The set-up number being edited is displayed in the LCP flashing.
[1]	Set-up 1 <i>Set-up 1</i> [1] to <i>Set-up 2</i> [2] can be edited freely during operation, independently of the active set-up.
[2]	Set-up 2
[9] *	Active Set-up (i.e. the set-up in which the frequency converter is operating) can also be edited during operation.

0-12 Link Setups	
Option:	Function:
	The link ensures synchronizing of the "not changeable during operation" parameter values enabling shift from one set-up to another during operation.  If the set-ups are not linked, a change between them is not possible while the motor is running. Thus the set-up change does not occur until the motor is coasted.
[0]	Not linked Leaves parameters unchanged in both set-ups and cannot be changed while motor runs.
[20] *	Linked Copies "not changeable during operation" parameters from one set-up to the other, so they are identical in both set-ups.

### 3.1.3 0-3\* LCP Custom Readout

It is possible to customize the display elements for various purposes: \*Custom Readout. Value proportional to speed (Linear, squared or cubed depending on unit selected in 0-30 Custom Readout Unit) \*Display Text. Text string stored in a parameter.

#### Custom Readout

The calculated value to be displayed is based on settings in 0-30 Custom Readout Unit, 0-31 Custom Readout Min Value (linear only), 0-32 Custom Readout Max Value, 4-14 Motor Speed High Limit [Hz] and actual speed.

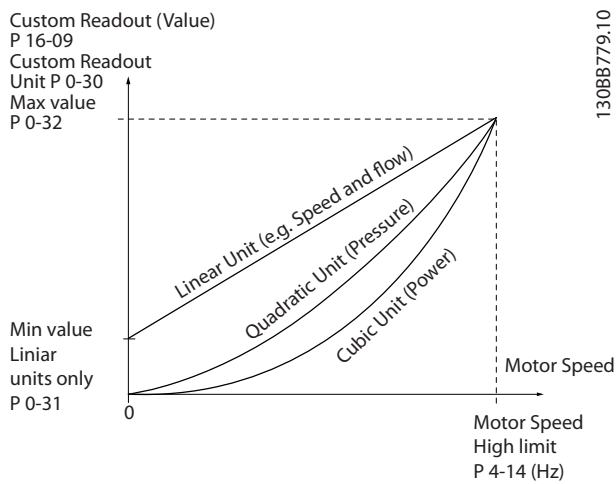

The relation will depend on the type of unit selected in 0-30 Custom Readout Unit:

Unit Type	Speed Relation
Dimensionless	Linear
Speed	
Flow, volume	
Flow, mass	
Velocity	
Length	
Temperature	
Pressure	Quadratic
Power	Cubic

0-30 Custom Readout Unit	
Option:	Function:
	Program a value to be shown in the display of the LCP. The value has a linear, squared or cubed relation to speed. This relation depends on the unit selected (see table above). The actual calculated value can be read in 16-09 Custom Readout.
[0]	None
[1] *	%

0-30 Custom Readout Unit	
Option:	Function:
[5]	PPM
[10]	l/Min
[11]	RPM
[12]	Pulse/s
[20]	l/s
[21]	l/min
[22]	l/h
[23]	m <sup>3</sup> /s
[24]	m <sup>3</sup> /min
[25]	m <sup>3</sup> /h
[30]	kg/s
[31]	kg/min
[32]	kg/h
[33]	t/min
[34]	t/h
[40]	m/s
[41]	m/min
[45]	m
[60]	Degree Celsius
[70]	mbar
[71]	bar
[72]	Pa
[73]	kPa
[74]	m Wg
[80]	kW
[120]	GPM
[121]	gal/s
[122]	gal/min
[123]	gal/h
[124]	CFM
[127]	ft <sup>3</sup> /h
[140]	ft/s
[141]	ft/min
[160]	Degree Fahr
[170]	psi
[171]	lb/in <sup>2</sup>
[172]	in WG
[173]	ft WG
[180]	hp

0-31 Custom Readout Min Value		
Range:	Function:	
0.0 CustomReadoutUnit*	[0.0 - 999999.99 CustomReadoutUnit]	This parameter allows the choice of the min. value of the custom defined readout (occurs at zero speed). It is only possible to select a value different to 0 when selecting a linear unit in 0-30 Custom Readout Unit. For Quadratic and Cubic units the minimum value will be 0.

0-32 Custom Readout Max Value		
Range:	Function:	
100.0 Custom-ReadoutUnit*	[0.0 - 999999.99 CustomRea-doutUnit]	This parameter sets the max value to be shown when the speed of the motor has reached the set value for <i>4-14 Motor Speed High Limit [Hz]</i> .

0-37 Display Text 1		
Range:	Function:	
0 *	[0 - 0 ]	In this parameter it is possible to write an individual text string to be read via serial communication. Only used when running BACnet.

0-38 Display Text 2		
Range:	Function:	
0 *	[0 - 0 ]	In this parameter it is possible to write an individual text string to be read via serial communication. Only used when running BACnet.

0-39 Display Text 3		
Range:	Function:	
0 *	[0 - 0 ]	In this parameter it is possible to write an individual text string to be read via serial communication. Only used when running BACnet.

### 3.1.4 0-4\* LCP

Enable, disable and password protect individual keys on the LCP.

0-40 [Hand on] Key on LCP		
Option:	Function:	
[0]	Disable All	Select Disabled [0] to avoid accidental start of the frequency converter in Hand Mode.
[1] *	Enable All	[Hand on] Key is enabled.

0-42 [Auto on] Key on LCP		
Option:	Function:	
[0]	Disable All	Select Disabled [0] to avoid accidental start of the frequency converter from LCP.
[1] *	Enable All	[Auto on] Key is enabled.

0-44 [Off / Reset] Key on LCP		
Option:	Function:	
[0]	Disable All	
[1] *	Enable All	
[2]	Enable Reset Only	Off is disabled.

### 3.1.5 0-5\* Copy / Save

Copy parameter settings between set-ups and to/from the LCP.

0-50 LCP Copy		
Option:	Function:	
[0] *	No copy	
[1]	All to LCP	Copies all parameters in all set-ups from the frequency converter memory to the LCP memory. For service purposes it is recommended to copy all parameters to the LCP after commissioning.
[2]	All from LCP	Copies all parameters in all set-ups from the LCP memory to the frequency converter memory.
[3]	Size indep. from LCP	Copies only the parameters that are independent of the motor size. The latter selection can be used to programme several frequency converters with the same function without disturbing motor data which are already set.

0-51 Set-up Copy		
Option:	Function:	
[0] *	No copy	No function
[1]	Copy from setup 1	Copy from setup 1 to setup 2.
[2]	Copy from setup 2	Copy from setup 2 to setup 1.
[9]	Copy from Factory setup	Copy factory setting to programming setup (chosen in <i>0-11 Programming Set-up</i> ).

### 3.1.6 0-6\* Password

0-60 Main Menu Password		
Range:	Function:	
0 *	[0.0 - 999.0 ]	Define the password for access to the Main Menu via the [Main Menu] key. Setting value to 0 disables the password-function.



### 3.2 Main Menu - Load and Motor - Group 1

Parameters related to the motor nameplate load compensations and application load type.

#### 3.2.1 1-0\* General Settings

1-00 Configuration Mode		
Option:	Function:	
[0] *	Open Loop	Motor speed is determined by applying a speed reference or by setting desired speed when in Hand Mode. Open Loop is also used if the frequency converter is part of a closed loop control system based on an external PI controller providing a speed reference signal as output.
[3]	Closed Loop	Motor Speed will be determined by a reference from the built-in PI controller varying the motor speed as of a closed loop control process (e.g. constant pressure or flow). The PI controller must be configured in parameter group20-**.

**NOTE**

This parameter cannot be changed when motor is running.

**NOTE**

When set for Closed Loop, the commands Reversing and Start Reversing will not reverse the direction of the motor.

1-01 Motor Control Principle		
Option:	Function:	
[0]	U/f	Is used for parallel connected motors and/or special motor applications. The U/f settings are set in parameters 1-55 and 1-56.  <b>NOTE</b> When running U/f control slip and load compensations are not included.
[1] *	VVC+	Normal running mode, including slip- and load compensations.

1-03 Torque Characteristics		
Option:	Function:	
[1] *	Variable Torque	<i>Variable Torque</i> [1]: For speed control of centrifugal pumps and fans. Also to be used when controlling more than one motor from the same frequency converter (e.g. multiple condenser fans or cooling tower fans). Provides a voltage which is optimized for a squared torque load characteristic of the motor.

1-03 Torque Characteristics		
Option:	Function:	
[3]	Auto Energy Optim.	<i>Auto Energy Optimization VT</i> [3]: For optimum energy efficient speed control of centrifugal pumps and fans. Provides a voltage which is optimized for a squared torque load characteristic of the motor but in addition the AEO feature will adapt the voltage exactly to the current load situation, thereby reducing energy consumption and audible noise from the motor.

1-06 Clockwise Direction		
Option:	Function:	
[0] *	Normal	Motor shaft will turn in clockwise direction when frequency converter is connected U -> U; V -> V, and W -> W to motor.
[1]	Inverse	Motor shaft will turn in counter clockwise direction when frequency converter is connected U -> U; V -> V, and W -> W to motor.

This parameter cannot be changed while the motor is running.

#### 3.2.2 1-2\* Motor Data

Parameter group 1-2\* comprises input data from the nameplate on the connected motor.

**NOTE**

Changing the value of these parameters affects the setting of other parameters.

1-20 Motor Power		
Range:	Function:	
[2]	0.12 kW - 0.16 hp	
[3]	0.18 kW - 0.25 hp	
[4]	0.25 kW - 0.33Hp	
[5]	0.37 kW - 0.50 hp	
[6]	0.55 kW - 0.75 hp	
[7]	0.75 kW - 1.00 hp	
[8]	1.10 kW - 1.50 hp	
[9]	1.50 kW - 2.00 hp	
[10]	2.20 kW - 3.00 hp	
[11]	3.00 kW - 4.00 hp	
[12]	3.70 kW - 5.00 hp	
[13]	4.00 kW - 5.40 hp	
[14]	5.50 kW - 7.50 hp	
[15]	7.50 kW - 10.0 hp	
[16]	11.00 kW - 15.00 hp	

1-20 Motor Power		
Range:		Function:
[17]	15.00kW - 20 hp	
[18]	18.5kW - 25 hp	
[19]	22kW - 30 hp	
[20]	30kW - 40 hp	
[21]	37kW - 50 hp	
[22]	45kW - 60 hp	
[23]	55kW - 75 hp	
[24]	75kW - 100 hp	
[25]	90kW - 120 hp	
[26]	110kW - 150 hp	

1-22 Motor Voltage		
Range:		Function:
Size related*	[50 - 1000 V]	Enter the nominal motor voltage according to the motor nameplate data. The default value corresponds to the nominal rated output of the unit. This parameter cannot be adjusted while the motor is running.

1-23 Motor Frequency		
Range:		Function:
Size related*	[20 - 400 Hz]	Select the motor frequency value from the motor nameplate data. For 87 Hz operation with 230/400 V motors, set the nameplate data for 230V/50Hz. Adapt 4-14 <i>Motor Speed High Limit [Hz]</i> and 3-03 <i>Maximum Reference</i> to the 87Hz application.

**NOTE**

This parameter cannot be adjusted while the motor is running.

1-24 Motor Current		
Range:		Function:
Size related*	[0.01 - 26.0 A]	Enter the nominal motor current value from the motor nameplate data. This data is used for calculating motor torque, motor thermal protection etc.

**NOTE**

This parameter cannot be adjusted while the motor is running.

1-25 Motor Nominal Speed		
Range:		Function:
Size related*	[100.0 - 60000.0 RPM]	Enter the nominal motor speed value from the motor nameplate data. This data is used for calculating automatic motor compensations.

**NOTE**

This parameter cannot be adjusted while the motor is running.

1-29 Automatic Motor Adaption (AMA)		
Option:		Function:
[0] *	Off	No function
[1]	Enable Complete AMA	Performs AMA of the stator resistance $R_s$ , the stator leakage reactance $X_1$ , the rotor leakage reactance $X_2$ and the main reactance $X_h$ .  <b>NOTE</b> Please note that terminal 27 Digital Input (5-12 <i>Terminal 27 Digital Input</i> ) has coast inverse as default setting. This means that AMA can not be performed if there is no 24V to terminal 27, so please connect terminal 12 to terminal 27.
[2]	Enable Reduced AMA	Performs a reduced AMA of the stator resistance $R_s$ in the system only. Select this option if an LC filter is used between the frequency converter and the motor.

Activate the AMA function by pressing [Hand on] after selecting [1] or [2]. After a normal sequence, the display will read: "Press [OK] to finish AMA". After pressing the [OK] key the frequency converter is ready for operation.

**NOTE**

- For the best adaptation of the frequency converter, run AMA on a cold motor
- AMA cannot be performed while the motor is running
- AMA can not be performed on a motor with a bigger power rating than the frequency converter, e.g. when a 5.5kW motor is connected to a 4kW frequency converter.

**NOTE**

Avoid generating external torque during AMA.

**NOTE**

If one of the settings in parameter group 1-2\* Motor Data is changed, the advanced motor parameters, 1-30 Stator Resistance (Rs) to 1-39 Motor Poles, will return to default setting.

This parameter cannot be adjusted while the motor is running.

**NOTE**

Full AMA should be run without filter only while reduced AMA should be run with filter.

3.2.3 1-3\* Adv. Motor Data

Parameters for advanced motor data. The motor data in 1-30 Stator Resistance (Rs) to 1-39 Motor Poles must match the relevant motor in order to run the motor optimally. The default settings are figures based on common motor parameter values from normal standard motors. If the motor parameters are not set correctly, a malfunction of the frequency converter system may occur. If the motor data is not known, running an AMA (Automatic Motor Adaptation) is recommended. See the *Automatic Motor Adaptation* section. The AMA sequence will adjust all motor parameters.

1-30 Stator Resistance (Rs)		
Range:	Function:	
Size related* [0.0 - 99.99 Ohm]	Set the stator resistance value. Enter the value from a motor data sheet or perform an AMA on a cold motor. This parameter cannot be adjusted while the motor is running.	

1-33 Stator Leakage Reactance (X1)		
Range:	Function:	
Size related* [0.0 - 999.9 Ohm]	Set stator leakage reactance of motor.	

1-35 Main Reactance (Xh)		
Range:	Function:	
Size related* [0.0 - 999.9 Ohm]	Set the main reactance of the motor using one of these methods:	
	<ol style="list-style-type: none"> <li>Run an AMA on a cold motor. The frequency converter will measure the value from the motor.</li> <li>Enter the X<sub>h</sub> value manually. Obtain the value from the motor supplier.</li> <li>Use the X<sub>h</sub> default setting. The frequency converter establishes the setting on the basis of the motor name plate data.</li> </ol>	

**NOTE**

This parameter cannot be adjusted while running.

1-39 Motor Poles														
Range:	Function:													
4.0 * [2.0 - 100.0 ]	Enter the number of motor poles.													
	<table border="1"> <thead> <tr> <th>Poles</th> <th>~n<sub>n</sub>@ 50Hz</th> <th>~n<sub>n</sub>@ 60Hz</th> </tr> </thead> <tbody> <tr> <td>2</td> <td>2700-3000</td> <td>3250-3600</td> </tr> <tr> <td>4</td> <td>1350-1500</td> <td>1625-1800</td> </tr> <tr> <td>6</td> <td>700-1000</td> <td>840-1200</td> </tr> </tbody> </table>	Poles	~n <sub>n</sub> @ 50Hz	~n <sub>n</sub> @ 60Hz	2	2700-3000	3250-3600	4	1350-1500	1625-1800	6	700-1000	840-1200	
Poles	~n <sub>n</sub> @ 50Hz	~n <sub>n</sub> @ 60Hz												
2	2700-3000	3250-3600												
4	1350-1500	1625-1800												
6	700-1000	840-1200												
	The table shows the number of poles for normal speed ranges of various motor types. Define motors designed for other frequencies separately. The motor pole value is always an even number, because it refers to the total number of poles, not pairs of poles. This parameter cannot be adjusted while the motor is running.													

3.2.4 1-4\* Cable Length

1-42 Motor Cable Length		
Range:	Function:	
50.0 m* [0.0 - 150.0 m]	Only effect on smaller drives. Set the motor cable length during commissioning	

1-43 Motor Cable Length Feet		
Range:	Function:	
144 ft* [0 - 431 ft]	Only effect on smaller drives. Set the motor cable length during commissioning	

3.2.5 1-5\* Load Indep. Setting

1-50 Motor Magnetisation at Zero Speed		
Range:	Function:	
100.0 %* [0.0 - 300.0 %]	Use this parameter along with 1-52 Min Speed Normal Magnetising [Hz] to obtain a different thermal load on the motor when running at low speed. Enter a value which is a percentage of the rated magnetising current. If the setting is too low, the torque on the motor shaft may be reduced.	

1-52 Min Speed Normal Magnetising [Hz]		
Range:	Function:	
0.0 Hz* [0.0 - 10.0 Hz]	Set the required frequency for normal magnetising current. Use this parameter along with 1-50 Motor Magnetisation at Zero Speed. See drawing for 1-50 Motor Magnetisation at Zero Speed.	

1-55 U/f Characteristic - U		
Range:	Function:	
Size related* [0.0 - 999.0 V]	Enter voltage at each frequency point to manually form a U/f characteristic matching motor. Frequency points are defined in 1-56 U/f Characteristic - F .	

1-56 U/f Characteristic - F		
Range:	Function:	
Size related* [0.0 - 400.0 Hz]	Enter frequency points to manually form a U/f characteristic matching motor. Voltage at each point is defined in 1-55 U/f Characteristic - U. Make a U/f characteristic based on 6 definable voltages and frequencies, see below figure. Simplify U/f characteristics by merging 2 or more points (voltages and frequencies), respectively, are set equal.	

3.2.6 1-6\* Load Depend. Setting

1-62 Slip Compensation		
Range:	Function:	
0 %* [-400 - 399 %]	Enter the % value for slip compensation to compensate for tolerances in the value of $n_{M,N}$ . Slip compensation is calculated automatically, i.e. on the basis of the rated motor speed $n_{M,N}$ .	

1-63 Slip Compensation Time Constant		
Range:	Function:	
0.1 s* [0.05 - 5.0 s]	Enter the slip compensation reaction speed. A high value results in slow reaction, and a low value results in quick reaction. If low-frequency resonance problems arise, use a longer time setting.	

1-64 Resonance Dampening		
Range:	Function:	
100.0 %* [0.0 - 500.0 %]	Enter the resonance dampening value. Set 1-64 Resonance Dampening and 1-65 Resonance Dampening Time Constant to help eliminate high-frequency resonance problems. To reduce resonance oscillation, increase the value of 1-64 Resonance Dampening.	

1-65 Resonance Dampening Time Constant		
Range:	Function:	
0.0050 %* [0.0050 - 0.05 %]	Set 1-64 Resonance Dampening and 1-65 Resonance Dampening Time Constant to help eliminate high-frequency resonance problems. Enter the time constant that provides the best dampening.	

3.2.7 1-7\* Start Adjustments

1-71 Start Delay		
Range:	Function:	
0.0 s* [0.0 - 10.0 s]	This parameter enables a delay of the starting time. The frequency converter begins with the start function selected in 1-72 Start Function. Set the start delay time until acceleration is to begin.	

1-72 Start Function		
Option:	Function:	
[0]	DC Hold/delay time	Motor is energized with 2-00 DC Hold/ Motor Preheat Current during start delay time.
[2] *	Coast/delay time	Inverter is coasted during start delay time (inverter off).

1-73 Flying Start		
Option:	Function:	
[0] *	Disabled	Select Enable [1] to enable the frequency converter to catch a motor spinning due to mains drop-out. Select Disable [0] if this function is not required. When par. 1-73 is enabled par. 1-71 and 1-72 have no function. Par 1-73 is active in VVC+ mode only.
[1]	Enabled	

### 3.2.8 1-8\* Stop Adjustments

1-80 Function at Stop		
Option:	Function:	
		Select the drive function after a stop command or after the speed is ramped down to the settings in par. 1-82. Function at Stop
[0] *	Coast	Leaves motor in free mode.
[1]	DC hold / Motor Preheat	Energizes motor with a DC holding current (see 2-00 DC Hold/Motor Preheat Current).

1-82 Min Speed for Function at Stop [Hz]		
Range:	Function:	
0.0 Hz*	[0.0 - 20.0 Hz]	Set the output frequency at which to activate 1-80 Function at Stop.

### 3.2.9 1-9\* Motor Temperature

1-90 Motor Thermal Protection		
Option:	Function:	
		Using ETR (Electronic Thermal Relay) the motor temperature is calculated based on frequency, speed and time. Danfoss recommends using the ETR function, if a thermistor is not present.  <b>NOTE</b> ETR calculation is based on motor data from group 1-2*.
[0] *	No protection	Disables temperature monitoring.
[1]	Thermistor warning	A thermistor connected to either digital or analog input gives a warning if upper limit of motor temperature range is exceeded, (see 1-93 Thermistor Source).
[2]	Thermistor trip	A thermistor connected to either digital or analog input gives an alarm and makes the frequency converter trip if upper limit of motor temperature range is exceeded, (see 1-93 Thermistor Source).
[3]	ETR warning 1	If calculated upper limit of motor temperature range is exceeded, a warning occurs.
[4]	ETR trip 1	If 90% of calculated upper limit of motor temperature range is exceeded, an alarm occurs and frequency converter trips.

1-93 Thermistor Source		
Option:	Function:	
		Select the input which the thermistor (PTC sensor) should be connected. When using an analog input, the same analog can not be used as a reference in par. 3-15 to 3-17.
[0] *	None	
[1]	Analog input AI53	
[6]	Digital input DI29	

#### NOTE

This parameter cannot be adjusted while the motor is running.

#### NOTE

Digital input should be set to [0] PNP - Active at 24V in 5-03 Digital Input 29 Mode.

### 3.3 Main Menu - Brakes - Group 2

2-00 DC Hold/Motor Preheat Current		
Range:		Function:
50.0 %*	[0.0 - 160.0 %]	Set holding current as a percentage of the rated motor current IM,N 1-24 Motor Current. 2-00 DC Hold/Motor Preheat Current holds the motor function (holding torque) or pre-heats the motor. This parameter is active if DC hold is selected in 1-72 Start Function [0] or 1-80 Function at Stop [1].

#### NOTE

The maximum value depends on the rated motor current. Avoid 100% current for too long. It may damage the motor.

2-01 DC Brake Current		
Range:		Function:
50.0 %*	[0.0 - 150.0 %]	Set current as % of rated motor current, 1-24 Motor Current. DC brake current is applied on stop command, when speed is below the limit set in 2-04 DC Brake Cut In Speed; when the DC Brake Inverse function is active; or via the serial port. See 2-02 DC Braking Time for duration.
50.0 %*	[0.0 - 150.0 %]	

#### NOTE

The maximum value depends on the rated motor current. Avoid 100% current for too long. It may damage the motor.

2-02 DC Braking Time		
Range:		Function:
10.0 s*	[0.0 - 60.0 s]	Set the duration of the DC braking current set in 2-01 DC Brake Current, once activated.

2-04 DC Brake Cut In Speed		
Range:		Function:
0.0 Hz*	[0.0 - 400.0 Hz]	This parameter is for setting the DC brake cut in speed at which the DC braking current 2-01 DC Brake Current is to be active, in connection with a stop command.

### 3.3.1 2-1\* Overvoltage Control

Par. group for selecting dynamic braking parameters.

2-10 Brake Function		
Option:		Function:
[0]	Off	No brake resistor installed.

2-17 Over-voltage Control		
Option:		Function:
		Select whether to enable OVC, which reduces the risk of drive trip due to over voltage on the DC link caused by generative power from load.
[0]	Disabled	No OVC required.
[2] *	Enabled	Activates OVC.

#### NOTE

The ramp time is automatically adjusted to avoid tripping of the frequency converter.

### 3.4 Main Menu - Reference/Ramps - Group 3

#### 3.4.1 3-0\* Reference Limits

Parameters for setting the reference unit, limits and ranges.

Please also see parameter group 20-0\* for information on settings in closed loop.

3-02 Minimum Reference		
Range:	Function:	
0.0 ReferenceFeed-backUnit*	[-4999.0 - 4999.0 ReferenceFeed-backUnit]	The Minimum Reference is the lowest value obtainable by summing all references.

3-03 Maximum Reference		
Range:	Function:	
50.0 Reference-FeedbackUnit*	[-4999.0 - 4999.0 ReferenceFeed-backUnit]	The Maximum Reference is the highest value obtainable by summing all references. The Maximum Reference unit matches the choice of configuration in 1-00 Configuration Mode.

#### 3.4.2 3-1\* References

3-10 Preset Reference		
Range:	Function:	
0.0 %*	[-100.0 - 100.0 %]	Enter up to eight different preset references (0-7) in this parameter, using array programming. Select Preset Reference bit 0 / 1 / 2 [16] , [17] or [18] for the corresponding digital inputs in parameter group 5.1* Digital Inputs.

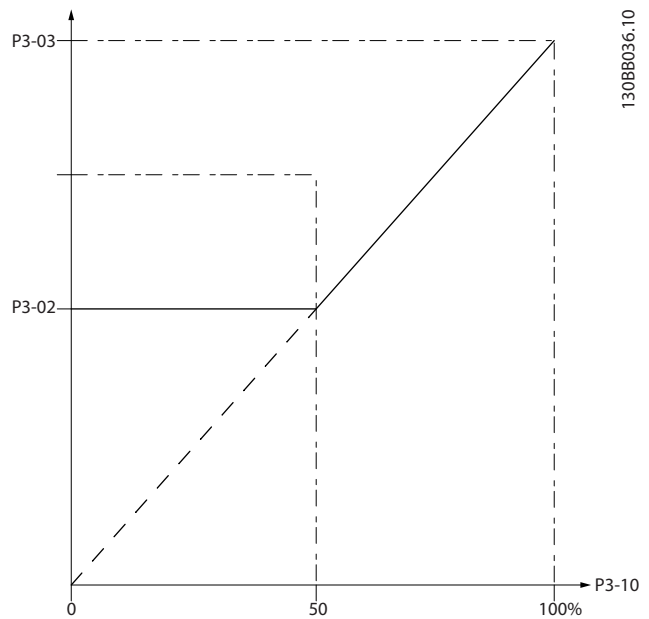

3-11 Jog Speed [Hz]		
Range:	Function:	
5.0 Hz*	[0.0 - 400.0 Hz]	The jog speed is a fixed output speed at which the frequency converter is running when the jog function is activated. See also 3-80 Jog Ramp Time.

3-14 Preset Relative Reference		
Range:	Function:	
0.0 %*	[-100.0 - 100.0 %]	Define fixed value in % to be added to variable value defined in par. 3-18, <i>Relative Scaling Reference Source</i> .  The sum of fixed and variable values (labelled Y in illustration below) is multiplied with actual reference (labelled X in illustration). This product is added to actual reference $X + X \times \frac{Y}{100}$

3-15 Reference 1 Source		
Option:	Function:	
[0]	No function	
[1] *	Analog in 53	Select the input to be used for the first reference signal. 3-15 Reference 1 Source, 3-16 Reference 2 Source and 3-17 Reference 3 Source define up to three different reference signals. The sum of these reference signals defines the actual reference. See also 1-93 Thermistor Source.

3-15 Reference 1 Source		
Option:	Function:	
[2]	Analog in 54	
[11]	Local bus reference	

3-16 Reference 2 Source		
Option:	Function:	
		Select the input to be used for the second reference signal. 3-15 Reference 1 Source, 3-16 Reference 2 Source and 3-17 Reference 3 Source define up to three different reference signals. The sum of these reference signals defines the actual reference. See also 1-93 Thermistor Source.
[0]	No function	
[1]	Analog in 53	
[2] *	Analog in 54	
[11]	Local bus reference	

3-17 Reference 3 Source		
Option:	Function:	
		Select the reference input to be used for the third reference signal. 3-15 Reference 1 Source, 3-16 Reference 2 Source and 3-17 Reference 3 Source define up to three different reference signals. The sum of these reference signals defines the actual reference.  This parameter cannot be adjusted while the motor is running.
[0]	No function	
[1]	Analog in 53	
[2]	Analog in 54	
[11] *	Local bus reference	

### 3.4.3 3-4\* Ramp 1

Configure the ramp parameter, ramping times, for each of the two ramps (parameter group 3-4\* and parameter group 3-5\*).

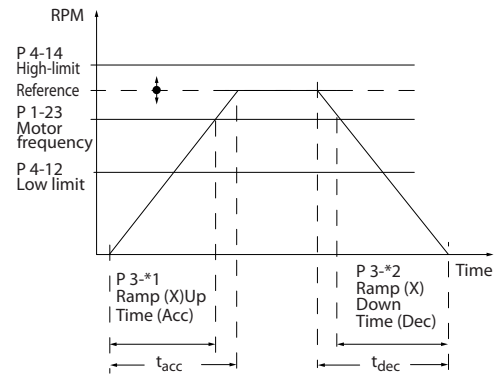

13088801.10

3

3-41 Ramp 1 Ramp up Time		
Range:	Function:	
Size related*	[0.05 - 3600.0 s]	Enter acceleration time from 0Hz to Motor Frequency in par 1-23. Choose a ramp-up time such that the output current does not exceed the current limit in par. 4-18 Current Limit during ramping. See ramp down time in par. 3-42.

3-42 Ramp 1 Ramp Down Time		
Range:	Function:	
Size related*	[0.05 - 3600.0 s]	Enter the deceleration time from 0 Hz the Motor Frequency in par 1-23 to 0 Hz. Choose a ramp-up time such that the output current does not exceed the current limit in par. 4-18 Current Limit during ramping. See ramp-up time in par. 3-41.

### 3.4.4 3-5\* Ramp 2

Choosing ramp parameters, see parameter group 3-4\*.

3-51 Ramp 2 Ramp up Time		
Range:	Function:	
Size related*	[0.05 - 3600.0 s]	Enter acceleration time from 0 Hz to 1-23 Motor Frequency. Choose a ramp-up time such that the output current does not exceed the current limit in 4-18 Current Limit during ramping. See ramp-down time in 3-52 Ramp 2 Ramp down Time.



3-52 Ramp 2 Ramp down Time		
Range:		Function:
Size related*	[0.05 - 3600.0 s]	Enter the deceleration time from 0Hz the <i>1-23 Motor Frequency</i> to 0Hz. Choose a ramp-up time such that the output current does not exceed the current limit in <i>4-18 Current Limit</i> during ramping. See ramp-up time in <i>3-51 Ramp 2 Ramp up Time</i> .

### 3.4.5 3-8\* Other Ramps

3-80 Jog Ramp Time		
Range:		Function:
Size related*	[0.05 - 3600.0 s]	Enter the jog ramp time, i.e. the acceleration/deceleration time between 0Hz to <i>1-23 Motor Frequency</i> . Ensure that the resultant output current required for the given jog ramp time does not exceed the current limit in <i>4-18 Current Limit</i> . The jog ramp time starts upon activation of a jog signal via the control panel, a selected digital input, or the serial communication port.

3-81 Quick Stop Ramp Time		
Range:		Function:
Size related*	[0.05 - 3600.0 s]	Enter the quick stop ramp time from the <i>1-23 Motor Frequency</i> to 0Hz. During ramping, no over-voltage may arise in the inverter, nor may the generated current exceed the limit in <i>4-18 Current Limit</i> is activated by means of a signal on a selected digital input or via the serial communication port.

### 3.5 Main Menu - Limits/Warnings - Group 4

#### 3.5.1 4-1\* Motor Limits

Define current and speed limits for the motor, and the reaction of the frequency converter when the limits are exceeded.

4-10 Motor Speed Direction		
Option:	Function:	
[0]	Clockwise	Only operation in clockwise direction will be allowed.
[2] *	Both directions	Operation in both clockwise and anti-clockwise direction will be allowed.

#### NOTE

The setting in *4-10 Motor Speed Direction* has impact on *1-73 Flying Start*.

4-12 Motor Speed Low Limit [Hz]		
Range:	Function:	
0.0 Hz*	[0.0 - 400.0 Hz]	Enter the minimum limit for motor speed. The Motor Speed Low Limit can be set to correspond to the minimum output frequency of the motor shaft. The Speed Low Limit must not exceed the setting in <i>4-14 Motor Speed High Limit [Hz]</i> .

4-14 Motor Speed High Limit [Hz]		
Range:	Function:	
65.0 Hz*	[0.1 - 400.0 Hz]	Enter the maximum limit for motor speed. <i>4-14 Motor Speed High Limit [Hz]</i> can be set to match the manufacturer's recommended max. motor speed. The Motor Speed High Limit must exceed the value in <i>4-12 Motor Speed Low Limit [Hz]</i> .

#### NOTE

Max. output frequency cannot exceed 10% of the inverter switching frequency (*14-01 Switching Frequency*).

#### NOTE

Motor Speed High Limit cannot be set higher than *4-19 Max Output Frequency*.

4-18 Current Limit		
Range:	Function:	
110.0 %*	[0.0 - 300.0 %]	Enter the current limit for motor and generator operation (in % of rated motor current. If the value is higher than maximum rated output from frequency converter, current will still be limited by the frequency converters maximum current). If a setting in <i>1-00 Configuration Mode</i> to <i>1-25 Motor Nominal Speed</i> is changed, <i>4-18 Current Limit</i> is not automatically reset to the default setting.

4-19 Max Output Frequency		
Range:	Function:	
65.0 Hz*	[0.0 - 400.0 Hz]	Enter the max. output frequency value. <i>4-19 Max Output Frequency</i> specifies the absolute limit on the frequency converter output frequency for improved safety in applications where accidental over-speeding must be avoided. This absolute limit applies to all configurations and is independent of the setting in <i>1-00 Configuration Mode</i> .

#### 3.5.2 4-5\* Adj. Warnings

Define adjustable warning limits for current. Warnings are shown on the display, programmed output or serial bus.

4-50 Warning Current Low		
Range:	Function:	
0.00 A*	[0.00 - 194.00 A]	Enter the I-low value. When the motor current falls below this limit, a bit in the drives statusword will be set. This value can also be programmed to produce a signal on the digital output or the relay output.

4-51 Warning Current High		
Range:	Function:	
194.00 A*	[0.00 - 194.00 A]	Enter the I-high value. When the motor current exceeds this limit, a bit in the drives statusword will be set. This value can also be programmed to produce a signal on the digital output or the relay output.

4-58 Missing Motor Phase Function		
Option:	Function:	
[0]	Off	No alarm is displayed if a missing motor phase occurs.
[1] *	On	An alarm is displayed if a missing motor phase occurs.

**NOTE**

This parameter cannot be adjusted while the motor is running.

3.5.3 4-6\* Speed Bypass

Define the Speed Bypass areas for the ramps. Some systems call for avoiding certain output frequencies or speeds, due to resonance problems in the system. Three frequency ranges can be avoided.

4-61 Bypass Speed From [Hz]		
Array [3]		
Range:	Function:	
0.0 Hz*	[0.0 - 400.0 Hz]	Some systems call for avoiding certain output speeds due to resonance problems in the system. Enter the lower limits of the speeds to be avoided.

4-63 Bypass Speed To [Hz]		
Array [3]		
Range:	Function:	
0.0 Hz*	[0.0 - 400.0 Hz]	Some systems call for avoiding certain output speeds due to resonance problems in the system. Enter the upper limits of the speeds to be avoided.

3.5.4 Semi-Automatic Bypass Speed Set-up

The Semi-Automatic Bypass Speed Set-up can be used to facilitate the programming of the frequencies to be skipped due to resonances in the system.

The following process is to be carried out:

1. Stop the motor.

**NOTE**

Please note that smaller frequency converters have a ramp time of 3 seconds which can make it difficult to set the bypass speeds. Please adjust the ramp times in 3-41 Ramp 1 Ramp up Time and 3-42 Ramp 1 Ramp Down Time.

2. Select Enabled in 4-64 Semi-Auto Bypass Set-up.
3. Press [Hand On] on the LCP to start the search for frequency bands causing resonances. The motor will ramp up according to the ramp set.

**NOTE**

Please note that terminal 27 Digital Input 5-12 Terminal 27 Digital Input has coast inverse as default setting. This means that [Hand On] will not start the motor if there is no 24V to terminal 27, so please connect terminal 12 to terminal 27.

4. When sweeping through a resonance band, press [OK] on the LCP when leaving the band. The actual frequency will be stored as the first element in 4-63 Bypass Speed To [Hz] (array). Repeat this for each resonance band identified at the ramp-up (maximum three can be adjusted).
5. When maximum speed has been reached, the motor will automatically begin to ramp-down. Repeat the above procedure when speed is leaving the resonance bands during the deceleration. The actual frequencies registered when pressing [OK] will be stored in 4-61 Bypass Speed From [Hz].
6. When the motor has ramped down to stop, press [OK]. The 4-64 Semi-Auto Bypass Set-up will automatically reset to Off. The frequency converter will stay in Hand On mode until [Off] or [Auto On] is pressed on the LCP.

If the frequencies for a certain resonance band are not registered in the right order (frequency values stored in By Pass Speed To are higher than those in By Pass Speed From) or if they do not have the same numbers of registrations for the By Pass From and By Pass To, all registrations will be cancelled and the following message is displayed: *Collected speed areas overlapping or not completely determined. Press [Cancel] to abort.*

4-64 Semi-Auto Bypass Set-up		
Option:	Function:	
[0] *	Off	
[1]	Enable	

### 3.6 Main Menu - Digital In/Out - Group 5

#### 3.6.1 5-0\* Digital I/O Mode

Parameters for configuring the input and output using NPN and PNP.

These parameters cannot be adjusted while the motor is running.

5-00 Digital Input Mode		
Option:	Function:	
		Set NPN or PNP mode for digital inputs 18,19 and 27. Digital Input Mode
[0] *	PNP	Action on positive directional pulses (0). PNP systems are pulled down to GND.
[1]	NPN	Action on negative directional pulses (1). NPN systems are pulled up to +24V, internally in the frequency converter.

5-03 Digital Input 29 Mode		
Option:	Function:	
[0] *	PNP	
[1]	NPN	

#### 3.6.2 5-1\* Digital Inputs

Parameters for configuring the input functions for the input terminals.

The digital inputs are used for selecting various functions in the frequency converter. All digital inputs can be set to the following functions:

Digital input function	Description
[0] No operation	No reaction to signals transmitted to terminal.
[1] Reset	Resets frequency converter after a TRIP/ALARM. Not all alarms can be reset.
[2] Coast inverse	Leaves motor in free mode. Logic '0' => coasting stop. (Default Digital input 27): Coasting stop, inverted input (NC).
[3] Coast and reset inverse	Reset and coasting stop inverted input (NC). Leaves motor in free mode and resets the frequency converter. Logic '0' => coasting stop and reset.
[4] Quick Stop inverse	Inverted input (NC). Generates a stop in accordance with the quick-stop ramp time set in 3-81 Quick Stop Ramp Time. When motor stops, shaft is in free mode.

[5] DC-brake inverse	Inverted input for DC braking (NC). Stops motor by energising it with DC current for a certain time period, see 2-01 DC Brake Current. Function is only active when value in 2-02 DC Braking Time is different from 0.
[6] Stop inverse	Stop inverted function. Generates stop function when selected terminal goes from logical level "1" to "0" (not latched). Stop is performed according to selected ramp time.
[7] External Interlock	Same function as Coasting stop, inverse, but External Interlock generates the alarm message 'external fault' on the display when the terminal which is programmed for Coast Inverse is logic '0'. The alarm message will also be active via digital outputs and relay outputs, if programmed for External Interlock. The alarm can be reset using a digital input or the [Reset] key if the cause for the External Interlock has been removed.
*[8] Start	Select start for a start/stop command. Logic '1' = start, logic '0' = stop. (Default Digital input 18)
[9] Latched start	Motor starts, if a pulse is applied for min. 2ms. Motor stops when Stop inverse is activated.
[10] Reversing	Change direction of motor shaft rotation. Reversing signal only changes direction of rotation; it does not activate start function. Select Both directions [2] in 4-10 Motor Speed Direction. 0 = normal, 1 = reversing.
[11] Start reversing	Use for start/stop and for reversing at the same time. Signals on start [8] are not allowed at the same time. 0 = stop, 1 = start reversing.
[14] Jog	Used for activating jog speed. See 3-11 Jog Speed [Hz]. (Default Digital input 29)
[16] Preset ref bit 0	Enables a choice between one of the eight preset references according to the table below.
[17] Preset ref bit 1	Enables a choice between one of the eight preset references according to the table below.
[18] Preset ref bit 2	Enables a choice between one of the eight preset references according to Table 3.1.
[19] Freeze reference	Freeze actual reference. The frozen reference is now the point of enable/condition for Speed up and Speed down to be used. If Speed up/down is used, speed change always follows ramp 2 (3-51 Ramp 2 Ramp up Time and 3-52 Ramp 2 Ramp down Time) in the range 3-02 Minimum Reference - 3-03 Maximum Reference.

[20] Freeze output	Freezes actual reference. The frozen reference is now the point of enable/condition for Speed up and Speed down to be used. If Speed up/down is used, the speed change always follows ramp 2
[21] Speed up	For digital control of the up/down speed is desired (motor potentiometer). Activate this function by selecting either Freeze reference or Freeze output. When Speed up is activated for less than 400 msec. the resulting reference will be increased by 0.1%. If Speed up is activated for more than 400 msec. the resulting reference will ramp according to Ramp 1 in 3-41 Ramp 1 Ramp up Time.
[22] Speed down	Same as Speed up [21], but reference decreases.
[23] Set-up select bit 0	Selects one of the two set-ups. Set 0-10 Active Set-up to Multi Set-up.
[34] Ramp bit 0	Select which ramp to use. Logic "0" will select ramp 1 while logic "1" will select ramp 2.
[37] Fire mode	A signal applied will put the frequency converter into Fire Mode and all other commands will be disregarded. See 24-0* Fire Mode.
[52] Run permissive	<p>The input terminal, for which the Run permissive has been programmed must be logic "1" before a start command can be accepted. Run permissive has a logic 'AND' function related to the terminal which is programmed for <i>START</i> [8], <i>Jog</i> [14] or <i>Freeze Output</i> [20], which means that in order to start running the motor, both conditions must be fulfilled. If Run permissive is programmed on multiple terminals, Run permissive needs only be logic '1' on one of the terminals for the function to be carried out. The digital output signal for Run Request (<i>Start</i> [8], <i>Jog</i> [14] or <i>Freeze output</i> [20]) programmed in par. 5-3*, or par. 5-4*, will not be affected by Run Permissive.</p> <p><b>NOTE</b>  <b>If no Run permissive signal is applied but either Run, Jog or Freeze commands is activated, the status line in the display will show either Run Requested, Jog Requested or Freeze Requested.</b></p>

[53] Hand Start	A signal applied will put the frequency converter into Hand mode as if button [Hand On] on the LCP has been pressed and a normal stop command will be overridden. If disconnecting the signal, the motor will stop. To make any other start commands valid, another digital input must be assigned to <i>Auto Start</i> and a signal applied to this. The [Hand On] and [Auto On] buttons on the LCP has no impact. The [Off] button on the LCP will override <i>Hand Start</i> and <i>Auto Start</i> . Press either the [Hand On] or [Auto On] button to make <i>Hand Start</i> and <i>Auto Start</i> active again. If no signal on neither <i>Hand Start</i> nor <i>Auto Start</i> , the motor will stop regardless of any normal Start command applied. If signal applied to both <i>Hand Start</i> and <i>Auto Start</i> , the function will be <i>Auto Start</i> .
[54] Auto start	A signal applied will put the frequency converter into Auto mode as if the LCP button [Auto On] has been pressed. See also <i>Hand Start</i> [53].
[60] Counter A (up)	Input for increment counting in the SLC counter.
[61] Counter A (down)	Input for decrement counting in the SLC counter.
[62] Reset Counter A	Input for reset of counter A.
[63] Counter B (up)	Input for increment counting in the SLC counter.
[64] Counter B (down)	Input for decrement counting in the SLC counter.
[65] Reset Counter B	Input for reset of counter B

Selected preset ref.:	Preset ref. bit 2	Preset ref. bit 1	Preset ref. bit
Preset reference 1	0	0	0
Preset reference 2	0	0	1
Preset reference 3	0	1	0
Preset reference 4	0	1	1
Preset reference 5	1	0	0
Preset reference 6	1	0	1
Preset reference 7	1	1	0
Preset reference 8	1	1	1

Table 3.1 Selected preset reference

5-10 Terminal 18 Digital Input		
Parameter for configuring the input function on input terminal 18.		
Option:	Function:	
[0]	No operation	
[1]	Reset	
[2]	Coast inverse	
[3]	Coast and reset inverse	
[4]	Quick Stop inverse	
[5]	DC-brake inverse	
[6]	Stop inverse	
[7]	External Interlock	
[8] *	Start	
[9]	Latched start	
[10]	Reversing	
[11]	Start reversing	
[14]	Jog	
[16]	Preset ref bit 0	
[17]	Preset ref bit 1	
[18]	Preset ref bit 2	
[19]	Freeze reference	
[20]	Freeze output	
[21]	Speed up	
[22]	Speed down	
[23]	Set-up select bit 0	
[34]	Ramp bit 0	
[37]	Fire mode	
[52]	Run permissive	
[53]	Hand Start	
[54]	Auto start	
[60]	Counter A (up)	
[61]	Counter A (down)	
[62]	Reset Counter A	
[63]	Counter B (up)	
[64]	Counter B (down)	
[65]	Reset Counter B	

5-11 Terminal 19 Digital Input		
Parameter for configuring the input function on input terminal 19.		
Option:	Function:	
[0] *	No operation	
[1]	Reset	
[2]	Coast inverse	
[3]	Coast and reset inverse	
[4]	Quick Stop inverse	
[5]	DC-brake inverse	
[6]	Stop inverse	
[7]	External Interlock	
[8]	Start	
[9]	Latched start	
[10]	Reversing	
[11]	Start reversing	
[14]	Jog	

5-11 Terminal 19 Digital Input		
Parameter for configuring the input function on input terminal 19.		
Option:	Function:	
[16]	Preset ref bit 0	
[17]	Preset ref bit 1	
[18]	Preset ref bit 2	
[19]	Freeze reference	
[20]	Freeze output	
[21]	Speed up	
[22]	Speed down	
[23]	Set-up select bit 0	
[34]	Ramp bit 0	
[37]	Fire mode	
[52]	Run permissive	
[53]	Hand Start	
[54]	Auto start	
[60]	Counter A (up)	
[61]	Counter A (down)	
[62]	Reset Counter A	
[63]	Counter B (up)	
[64]	Counter B (down)	
[65]	Reset Counter B	

5-12 Terminal 27 Digital Input		
Parameter for configuring the input function on input terminal 27.		
Option:	Function:	
[0]	No operation	
[1]	Reset	
[2] *	Coast inverse	
[3]	Coast and reset inverse	
[4]	Quick Stop inverse	
[5]	DC-brake inverse	
[6]	Stop inverse	
[7]	External Interlock	
[8]	Start	
[9]	Latched start	
[10]	Reversing	
[11]	Start reversing	
[14]	Jog	
[16]	Preset ref bit 0	
[17]	Preset ref bit 1	
[18]	Preset ref bit 2	
[19]	Freeze reference	
[20]	Freeze output	
[21]	Speed up	
[22]	Speed down	
[23]	Set-up select bit 0	
[34]	Ramp bit 0	
[37]	Fire mode	
[52]	Run permissive	
[53]	Hand Start	
[54]	Auto start	

5-12 Terminal 27 Digital Input		
Parameter for configuring the input function on input terminal 27.		
Option:	Function:	
[60]	Counter A (up)	
[61]	Counter A (down)	
[62]	Reset Counter A	
[63]	Counter B (up)	
[64]	Counter B (down)	
[65]	Reset Counter B	

5-13 Terminal 29 Digital Input		
Parameter for configuring the input function on input terminal 29.		
Option:	Function:	
[0]	No operation	
[1]	Reset	
[2]	Coast inverse	
[3]	Coast and reset inverse	
[4]	Quick Stop inverse	
[5]	DC-brake inverse	
[6]	Stop inverse	
[7]	External Interlock	
[8]	Start	
[9]	Latched start	
[10]	Reversing	
[11]	Start reversing	
[14] *	Jog	
[16]	Preset ref bit 0	
[17]	Preset ref bit 1	
[18]	Preset ref bit 2	
[19]	Freeze reference	
[20]	Freeze output	
[21]	Speed up	
[22]	Speed down	
[23]	Set-up select bit 0	
[34]	Ramp bit 0	
[37]	Fire mode	
[52]	Run permissive	
[53]	Hand Start	
[54]	Auto start	
[60]	Counter A (up)	
[61]	Counter A (down)	
[62]	Reset Counter A	
[63]	Counter B (up)	
[64]	Counter B (down)	
[65]	Reset Counter B	

### 3.6.3 5-4\* Relays

Parameters for configuring the timing and the output functions for the relays.

5-40 Function Relay		
<b>Array (Relay 1 [0], Relay 2 [1])</b>		
Select options to define the function of the relays. The selection of each mechanical relay is realised in an array parameter.		
Option:	Function:	
[0] *	No operation	Default for both relays
[1]	Control ready	Control board receives supply voltage.
[2]	Drive ready	Frequency converter is ready for operation and applies supply signal on control board.
[3]	Drive ready/ remote control	Frequency converter is ready for operation in Auto On-mode.
[4]	Standby / no warning	Frequency converter is ready for operation. No start or stop command is given. No warnings are present.
[5]	VLT running	Motor is running.
[6]	Running / no warning	Motor runs, and no warning are present.
[7]	Run in range/no warning	Motor runs within programmed current ranges, see 4-50 <i>Warning Current Low</i> and 4-51 <i>Warning Current High</i> . No warnings are present.
[8]	Run on ref/no warning	Motor runs at reference speed and with no warnings.
[9]	Alarm	An alarm activates output.
[10]	Alarm or warning	An alarm or warning activates output.
[12]	Out of current range	Motor current is outside range set in 4-50 <i>Warning Current Low</i> and 4-51 <i>Warning Current High</i> .
[13]	Below current, low	Motor current is lower than set in 4-50 <i>Warning Current Low</i> .
[14]	Above current, high	Motor current is higher than set in 4-51 <i>Warning Current High</i> .
[21]	Thermal warning	The thermal warning turns on when the temperature exceeds the limit in motor, frequency converter or thermistor.
[22]	Ready, no thermal warning	Frequency converter is ready for operation and no over-temperature warning is present.
[23]	Remote, ready, no thermal warning	Frequency converter is ready for operation in Auto mode, and no over-temperature warning is present.

5-40 Function Relay		
Array (Relay 1 [0], Relay 2 [1])		
Select options to define the function of the relays. The selection of each mechanical relay is realised in an array parameter.		
Option:	Function:	
[24]	Ready, Voltage OK	Frequency converter is ready for operation and mains voltage is within specified voltage range.
[25]	Reverse	Motor runs/is ready to run clockwise when logic = 0 and counter clockwise when logic = 1. Output changes as soon as reversing signal is applied.
[26]	Bus OK	Active communication (no time-out) via serial communication port.
[35]	External Interlock	See digital input.
[36]	Control word bit 11	Bit 11 in control word controls relay.
[37]	Control word bit 12	Bit 12 in control word controls relay.
[45]	Bus Control	
[60]	Comparator 0	See parameter group 13-1*. If Comparator 0 is evaluated as TRUE, the output will go high. Otherwise, it will be low.
[61]	Comparator 1	See parameter group 13-1*. If Comparator 2 is evaluated as TRUE, the output will go high. Otherwise, it will be low.
[62]	Comparator 2	See parameter group 13-1*. If Comparator 2 is evaluated as TRUE, the output will go high. Otherwise, it will be low.
[63]	Comparator 3	See parameter group 13-1*. If Comparator 3 is evaluated as TRUE, the output will go high. Otherwise, it will be low.
[64]	Comparator 4	See parameter group 13-1*. If Comparator 4 is evaluated as TRUE, the output will go high. Otherwise, it will be low.
[65]	Comparator 5	See parameter group 13-1*. If Comparator 5 is evaluated as TRUE, the output will go high. Otherwise, it will be low.
[70]	Logic rule 0	See parameter group 13-4*. If Logic Rule 0 is evaluated as TRUE, the output will go high. Otherwise, it will be low.
[71]	Logic rule 1	See parameter group 13-4*. If Logic Rule 1 is evaluated as TRUE, the output will go high. Otherwise, it will be low.
[72]	Logic rule 2	See parameter group 13-4*. If Logic Rule 2 is evaluated as TRUE, the output will go high. Otherwise, it will be low.
[73]	Logic rule 3	See parameter group 13-4*. If Logic Rule 3 is evaluated as TRUE, the output will go high. Otherwise, it will be low.

5-40 Function Relay		
Array (Relay 1 [0], Relay 2 [1])		
Select options to define the function of the relays. The selection of each mechanical relay is realised in an array parameter.		
Option:	Function:	
[74]	Logic rule 4	See parameter group 13-4*. If Logic Rule 4 is evaluated as TRUE, the output will go high. Otherwise, it will be low.
[75]	Logic rule 5	See parameter group 13-4*. If Logic Rule 5 is evaluated as TRUE, the output will go high. Otherwise, it will be low.
[80]	SL digital output A	See 13-52 <i>SL Controller Action</i> . The input will go high whenever the Smart Logic Action [38] <i>Set dig. out. A high</i> is executed. The input will go low whenever the Smart Logic Action [32] <i>Set dig. out. A low</i> is executed.
[81]	SL digital output B	See 13-52 <i>SL Controller Action</i> . The input will go high whenever the Smart Logic Action [39] <i>Set dig. out. B high</i> is executed. The input will go low whenever the Smart Logic Action [33] <i>Set dig. out. B low</i> is executed.
[82]	SL digital output C	See 13-52 <i>SL Controller Action</i> . The input will go high whenever the Smart Logic Action [40] <i>Set dig. out. C high</i> is executed. The input will go low whenever the Smart Logic Action [34] <i>Set dig. out. C low</i> is executed.
[83]	SL digital output D	See 13-52 <i>SL Controller Action</i> . The input will go high whenever the Smart Logic Action [41] <i>Set dig. out. D high</i> is executed. The input will go low whenever the Smart Logic Action [35] <i>Set dig. out. D low</i> is executed.
[160]	No alarm	The output is high when no alarm is present.
[161]	Running reverse	The output is high when the frequency converter is running counter clockwise (the logical product of the status bits 'running' AND 'reverse').
[165]	Local ref. active	The output is high when 3-13 <i>Reference Site</i> = [2] <i>Local</i> or when 3-13 <i>Reference Site</i> = [0] <i>Linked to hand auto</i> at the same time as the LCP is in [Hand on] mode.
[166]	Remote ref. active	The output is high when 3-13 <i>Reference Site</i> [1] or <i>Linked to hand/auto</i> [0] while the LCP is in [Auto on] mode.
[167]	Start command activ	The output is high when there is an active Start command (i.e. via digital input bus connection or [Hand on] or [Auto on], and no Stop command is active.



5-40 Function Relay		
Array (Relay 1 [0], Relay 2 [1])		
Select options to define the function of the relays. The selection of each mechanical relay is realised in an array parameter.		
Option:	Function:	
[168]	Drive in hand mode	The output is high when the frequency converter is in Hand on mode (as indicated by the LED light above [Hand on]).
[169]	Drive in auto mode	The output is high when the frequency converter is in Hand on mode (as indicated by the LED light above [Auto on]).
[193]	Sleep Mode	The frequency converter/system has turned into sleep mode. See par. 22-4*.
[194]	Broken Belt Function	A Broken Belt condition has been detected. This function must be enabled in 22-60 Broken Belt Function.
[196]	Fire Mode	The frequency converter is operating in Fire Mode. See parameter group 24-0* Fire Mode.
[198]	Drive Bypass	To be used as signal for activating an external electromechanical bypass switching the motor direct on line. See 24-1* Drive Bypass.

### 3.6.4 5-9\* Bus Controlled

This parameter group selects digital and relay outputs via a fieldbus setting.

5-90 Digital & Relay Bus Control		
Range:	Function:	
0.0 *	[0.0 - 0xFFFFFFFF ]	This parameter holds the state of the digital outputs and relays that is controlled by bus. A logical '1' indicates that the output is high or active. A logical '0' indicates that the output is low or inactive.

Bit 0 - 3	Reserved
Bit 4	Relay 1 output terminal
Bit 5	Relay 2 output terminal
Bit 6 - 23	Reserved
Bit 24	Terminal 42 Digital Output
Bit 25	Terminal 45 Digital Output
Bit 26 - 31	Reserved

### 3.7 Main Menu - Analog In/Out - Group 6

Parameter group for setting up the analog I/O configuration and the digital output. The frequency converter is equipped with 2 analog inputs: Terminal 53 and 54. The analog inputs can freely be allocated to either voltage (0 - 10V) or current input (0/4 - 20mA)

#### 3.7.1 6-0\* Analog I/O Mode

6-00 Live Zero Timeout Time		
Range:	Function:	
10.0 s*	[1.0 - 99.0 s]	Enter the time-out time.

6-01 Live Zero Timeout Function		
Option:	Function:	
	Select the time-out function. The function set in 6-01 Live Zero Timeout Function will be activated if the input signal on terminal 53 or 54 is below 50% of the value in 6-10 Terminal 53 Low Voltage, 6-12 Terminal 53 Low Current, 6-20 Terminal 54 Low Voltage or 6-22 Terminal 54 Low Current for a time period defined in 6-00 Live Zero Timeout Time.	
[0] *	Off	
[1]	Freeze output	
[2]	Stop	
[3]	Jogging	
[4]	Max. speed	
[5]	Stop and trip	

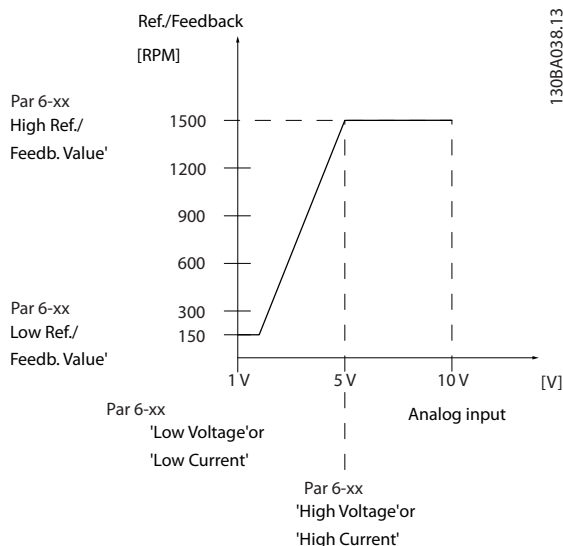

#### 3.7.2 6-1\* Analog Input 53

Parameters for configuring the scaling and limits for analog input 53 (terminal 53).

6-10 Terminal 53 Low Voltage		
Range:	Function:	
0.07 V*	[0.0 - 10.0 V]	Enter the voltage (V) that corresponds to 6-14 Terminal 53 Low Ref./Feedb. Value. The value must be set at >1V in order to activate 6-01 Live Zero Timeout Function.

6-11 Terminal 53 High Voltage		
Range:	Function:	
10.0 V*	[0.0 - 10.0 V]	Enter the voltage (V) that corresponds to the high reference value (set in par. 6-15).

6-12 Terminal 53 Low Current		
Range:	Function:	
4.0 mA*	[0.0 - 20.0 mA]	Enter the low current value. This reference signal should correspond to the low reference/feedback value, set in 6-14 Terminal 53 Low Ref./Feedb. Value. The value must be set at >2mA in order to activate the Live Zero Time-out Function in 6-01 Live Zero Timeout Function.

6-13 Terminal 53 High Current		
Range:	Function:	
20.0 mA*	[0.0 - 20.0 mA]	Enter the high current value corresponding to the high reference/feedback set in 6-15 Terminal 53 High Ref./Feedb. Value.

6-14 Terminal 53 Low Ref./Feedb. Value		
Range:	Function:	
0.0 *	[-4999.0 - 4999.0]	Enter the reference or feedback value that corresponds to the voltage or current set in par. 6-10/6-12.

6-15 Terminal 53 High Ref./Feedb. Value		
Range:	Function:	
50.0 *	[-4999.0 - 4999.0]	Enter the reference or feedback value that corresponds to the voltage or current set in par. 6-11/6-13.

3

6-16 Terminal 53 Filter Time Constant		
Range:		Function:
0.01 s*	[0.01 - 10.0 s]	Enter the time constant. This is a first-order digital low pass filter time constant for suppressing electrical noise in terminal 53. A high time constant value improves dampening but also increases the time delay through the filter. This parameter cannot be adjusted while the motor is running.

6-19 Terminal 53 mode		
Option:		Function:
		Select if terminal 54 is used for current- or voltage input.
[0]	Current mode	
[1]	Voltage mode	

### 3.7.3 6-2\* Analog Input 54

Parameters for configuring the scaling and limits for analog input 54 (terminal 54).

6-20 Terminal 54 Low Voltage		
Range:		Function:
0.07 V*	[0.0 - 10.0 V]	Enter the voltage (V) that corresponds to the low reference value (set in 6-24 Terminal 54 Low Ref./Feedb. Value). The value must be set at >1V in order to activate 6-01 Live Zero Timeout Function.

6-21 Terminal 54 High Voltage		
Range:		Function:
10.0 V*	[0.0 - 10.0 V]	Enter the voltage (V) that corresponds to the high reference value (set in 6-25 Terminal 54 High Ref./Feedb. Value).

6-22 Terminal 54 Low Current		
Range:		Function:
4.0 mA*	[0.0 - 20.0 mA]	Enter the low current value. This reference signal should correspond to the low reference/feedback value, set in 6-24 Terminal 54 Low Ref./Feedb. Value. The value must be set at >2 mA in order to activate the Live Zero Timeout Function in 6-01 Live Zero Timeout Function.

6-23 Terminal 54 High Current		
Range:		Function:
20.0 mA*	[0.0 - 20.0 mA]	Enter the high current value corresponding to the high reference/feedback value set in 6-25 Terminal 54 High Ref./Feedb. Value.
20.0 mA*	[par. 6-22 - 20.00 mA]	

6-24 Terminal 54 Low Ref./Feedb. Value		
Range:		Function:
0.0 *	[-4999.0 - 4999.0 ]	Enter the reference or feedback value that corresponds to the voltage or current set in 6-21 Terminal 54 High Voltage/6-22 Terminal 54 Low Current.

6-25 Terminal 54 High Ref./Feedb. Value		
Range:		Function:
50.0 *	[-4999.0 - 4999.0 ]	Enter the reference or feedback value that corresponds to the voltage or current set in 6-21 Terminal 54 High Voltage/6-23 Terminal 54 High Current.

6-26 Terminal 54 Filter Time Constant		
Range:		Function:
0.01 s*	[0.01 - 10.0 s]	Enter the time constant. This is a first-order digital low pass filter time constant for suppressing electrical noise in terminal 54. A high time constant value improves dampening but also increases the time delay through the filter. This parameter cannot be adjusted while the motor is running.

6-29 Terminal 54 mode		
Option:		Function:
		Select if terminal 54 is used for current- or voltage input.
[0]	Current mode	
[1]	Voltage mode	

### 3.7.4 6-7\* Analog/Digital Output 45

Parameters for configuring the scaling and limits for analog/digital output Terminal 45. Analog outputs are current outputs: 0/4 - 20mA. Resolution on analog output is 12 bit. Analog output terminals can also be setup as digital output.

6-70 Terminal 45 Mode		
Option:		Function:
		Set terminal 45 to act as analog output or as digital output.
[0] *	0-20 mA	
[1]	4-20 mA	
[2]	Digital Output	

6-71 Terminal 45 Analog Output		
Option:		Function:
		Select the function of Terminal 45 as an analog current output. See also 6-70 Terminal 45 Mode.
[0] *	No operation	
[100]	Output frequency	0 - 100Hz

6-71 Terminal 45 Analog Output		
Option:	Function:	
[101]	Reference	MinRef. - MaxRef.
[102]	Feedback	MinFB - MaxFB
[103]	Motor current	0 - I <sub>max</sub>
[106]	Power	0 - P <sub>nom</sub>
[139]	Bus Control	0 - 100%

6-72 Terminal 45 Digital Output		
Option:	Function:	
		Select the function of Terminal 45 as a digital current output. See also 6-70 Terminal 45 Mode. See 5-40 Function Relay for description of the choices.
[0] *	No operation	
[1]	Control ready	
[2]	Drive ready	
[3]	Drive ready/remote control	
[4]	Standby / no warning	
[5]	VLT running	
[6]	Running / no warning	
[7]	Run in range/no warning	
[8]	Run on ref/no warning	
[9]	Alarm	
[10]	Alarm or warning	
[12]	Out of current range	
[13]	Below current, low	
[14]	Above current, high	
[21]	Thermal warning	
[22]	Ready, no thermal warning	
[23]	Remote, ready, no thermal warning	
[24]	Ready, Voltage OK	
[25]	Reverse	
[26]	Bus OK	
[35]	External Interlock	
[36]	Control word bit 11	
[45]	Bus Control	
[60]	Comparator 0	
[61]	Comparator 1	
[62]	Comparator 2	
[63]	Comparator 3	
[64]	Comparator 4	
[65]	Comparator 5	
[70]	Logic rule 0	
[71]	Logic rule 1	
[72]	Logic rule 2	
[73]	Logic rule 3	
[74]	Logic rule 4	
[75]	Logic rule 5	

6-72 Terminal 45 Digital Output		
Option:	Function:	
[80]	SL digital output A	
[81]	SL digital output B	
[82]	SL digital output C	
[83]	SL digital output D	
[160]	No alarm	
[161]	Running reverse	
[165]	Local ref. active	
[166]	Remote ref. active	
[167]	Start command activ	
[168]	Drive in hand mode	
[169]	Drive in auto mode	
[193]	Sleep Mode	
[194]	Broken Belt Function	
[196]	Fire Mode	
[198]	Drive Bypass	

6-73 Terminal 45 Output Min Scale		
Range:	Function:	
0.0 %* [0.0 - 200.0 %]	Scale for the minimum output (0 or 4mA) of the analogue signal at Terminal 45. Set the value to be the percentage of the full range of the variable selected in 6-71 Terminal 45 Analog Output.	

6-74 Terminal 45 Output Max Scale		
Range:	Function:	
100.0 %* [0.0 - 200.0 %]	Scale for the maximum output (20mA) of the analog signal at Terminal 45. Set the value to be the percentage of the full range of the variable selected in 6-71 Terminal 45 Analog Output.	

6-76 Terminal 45 Output Bus Control		
Range:	Function:	
0.0 %*	[0.0 - 100.0 %]	

### 3.7.5 6-9\* Analog/Digital Output 42

Parameters for configuring the limits for analog/digital output Terminal 42. Analog outputs are current outputs: 0/4 - 20mA. Resolution on analog outputs is 12 bit. Analog output terminals can also be setup as digital output.

6-90 Terminal 42 Mode		
Option:	Function:	
		Set Terminal 42 to act as analog output or as digital output.
[0] *	0-20 mA	
[1]	4-20 mA	
[2]	Digital Output	

6-91 Terminal 42 Analog Output		
Option:	Function:	
		Select the function of Terminal 42 as an analog current output. See also <i>6-90 Terminal 42 Mode</i> .
[0] *	No operation	
[100]	Output frequency	0 - 100Hz
[101]	Reference	MinRef. - MaxRef.
[102]	Feedback	MinFB - MaxFB
[103]	Motor current	0 - I <sub>max</sub>
[106]	Power	0 - P <sub>nom</sub>
[139]	Bus Control	0 - 100%

6-92 Terminal 42 Digital Output		
Option:	Function:	
		Select the function of Terminal 42 as an analog current output. See also <i>6-90 Terminal 42 Mode</i> . See <i>5-40 Function Relay</i> for description of the choices.
[0] *	No operation	
[1]	Control ready	
[2]	Drive ready	
[3]	Drive ready/remote control	
[4]	Standby / no warning	
[5]	VLT running	
[6]	Running / no warning	
[7]	Run in range/no warning	
[8]	Run on ref/no warning	
[9]	Alarm	
[10]	Alarm or warning	
[12]	Out of current range	
[13]	Below current, low	
[14]	Above current, high	
[21]	Thermal warning	

6-92 Terminal 42 Digital Output		
Option:	Function:	
[22]	Ready, no thermal warning	
[23]	Remote, ready, no thermal warning	
[24]	Ready, Voltage OK	
[25]	Reverse	
[26]	Bus OK	
[35]	External Interlock	
[36]	Control word bit 11	
[45]	Bus Control	
[60]	Comparator 0	
[61]	Comparator 1	
[62]	Comparator 2	
[63]	Comparator 3	
[64]	Comparator 4	
[65]	Comparator 5	
[70]	Logic rule 0	
[71]	Logic rule 1	
[72]	Logic rule 2	
[73]	Logic rule 3	
[74]	Logic rule 4	
[75]	Logic rule 5	
[80]	SL digital output A	
[81]	SL digital output B	
[82]	SL digital output C	
[83]	SL digital output D	
[160]	No alarm	
[161]	Running reverse	
[165]	Local ref. active	
[166]	Remote ref. active	
[167]	Start command activ	
[168]	Drive in hand mode	
[169]	Drive in auto mode	
[193]	Sleep Mode	
[194]	Broken Belt Function	
[196]	Fire Mode	
[198]	Drive Bypass	

6-93 Terminal 42 Output Min Scale		
Range:	Function:	
0.0 %*	[0.0 - 200.0 %]	Scale for the minimum output (0 or 4mA) of the analogue signal at Terminal 42. Set the value to be the percentage of the full range of the variable selected in <i>6-91 Terminal 42 Analog Output</i> .

6-94 Terminal 42 Output Max Scale		
Range:		Function:
100.0 %*	[0.0 - 200.0 %]	<p>Scale for the maximum output (20mA) of the scaling at Terminal 42. Set the value to be the percentage of the full range of the variable selected in 6-91 Terminal 42 Analog Output.</p> <p>0/4 20 Current (mA)</p> <p>0% Analogue Output Min Scale par. 6-93    Analogue Output Max Scale par. 6-94    100% Variable for output example: Power</p>

6-96 Terminal 42 Output Bus Control		
Range:		Function:
0.0 %*	[0.0 - 100.0 %]	

### 3.8 Main Menu - Communications and Options - Group 8

#### 3.8.1 8-0\* General Settings

8-01 Control Site		
Option:	Function:	
		Select Digital and ctrl.word [0] for using digital input and control word. Select Digital only [1] to use digital inputs only. Select Control word only [2] to use control word only. This parameter overrules settings in 8-50 Coasting Select to 8-56 Preset Reference Select.
[0] *	Digital and ctrl.word	Control by using both digital input and control word.
[1]	Digital only	Control by using digital inputs only.
[2]	Controlword only	Control by using control word only.

8-02 Control Source		
Option:	Function:	
		Select the source of the control word.
[0]	None	
[1] *	FC Port	

#### NOTE

This parameter cannot be adjusted while the motor is running.

8-03 Control Timeout Time		
Range:	Function:	
1.0 s*	[0.1 - 6500.0 s]	Enter the maximum time expected to pass between the reception of two consecutive telegrams. If this time is exceeded, it indicates that the serial communication has stopped. The function selected in 8-04 Control Timeout Function Control Time-out Function will then be carried out.

8-04 Control Timeout Function		
Option:	Function:	
		Select the timeout function. The timeout function is activated when the control word fails to be updated within the time period specified in 8-03 Control Timeout Time.
[0] *	Off	
[1]	Freeze output	
[2]	Stop	
[3]	Jogging	
[4]	Max. speed	
[5]	Stop and trip	

8-04 Control Timeout Function		
Option:	Function:	
[20]	N2 Override Release	

8-06 Reset Control Word Timeout		
Option:	Function:	
[0] *	No function	
[1]	Do reset	Reset control word timeout.

#### 3.8.2 8-3\* FC Port Settings

8-30 Protocol		
Option:	Function:	
		Select the protocol for the integrated RS-485 port.
[0] *	FC	Communication according to the FC Protocol.
[2]	Modbus RTU	Communication according to the Modbus RTU protocol.
[3]	Metasys N2	Communication protocol. The N2 software protocol is designed to be general in nature in order to accommodate the unique properties each device may have.
[5]	BACNet	

#### NOTE

Further details can be found in the Metasys manual.

8-31 Address		
Range:	Function:	
1.0 *	[0.0 - 247 ]	Enter the address for the RS-485 port. Valid range: 1 - 126 for FC-bus OR 1-247 for Modbus.

8-32 Baud Rate		
Option:	Function:	
		Select the baud rate for the RS-485 port
[0]	2400 Baud	
[1]	4800 Baud	
[2] *	9600 Baud	
[3]	19200 Baud	
[4]	38400 Baud	
[5]	57600 Baud	
[6]	76800 Baud	
[7]	115200 Baud	

Default refers to the FC Protocol.

8-33 Parity / Stop Bits		
Option:	Function:	
		Parity and Stop Bits for the protocol using the FC Port. For some of the protocols, not all options are available.
[0] *	Even Parity, 1 Stop Bit	

8-33 Parity / Stop Bits		
Option:	Function:	
[1]	Odd Parity, 1 Stop Bit	
[2]	No Parity, 1 Stop Bit	
[3]	No Parity, 2 Stop Bits	

8-35 Minimum Response Delay		
Range:	Function:	
0.01 s* [0.0010 - 0.5 s]	Specify the minimum delay time between receiving a request and transmitting a response. This is used for overcoming modem turnaround delays.	

8-36 Maximum Response Delay		
Range:	Function:	
Size related* [0.1 - 10.0 s]	Specify the maximum permissible delay time between receiving a request and transmitting the response. If this time is exceeded, no response will be returned.	

8-37 Maximum Inter-char delay		
Range:	Function:	
0.025 s* [0.025 - 0.025 s]	Specify the maximum delay time between 2 characters in a message. Exceeding this delay time will cause the message to be discarded.	

### 3.8.3 8-5\* Digital/Bus

Parameters for configuring the control word Digital/Bus merging.

8-50 Coasting Select		
Option:	Function:	
		Select control of the coasting function via the terminals (digital input) and/or via the bus. <b>NOTE</b> This parameter is active only when <b>8-01 Control Site</b> is set to [0] Digital and control word.
[0]	Digital input	Activates coast via a digital input.
[1]	Bus	Activates coast via the serial communication port.
[2]	Logic AND	Activates coast via the fieldbus/serial communication port, AND additionally via one of the digital inputs.
[3] *	Logic OR	Activates coast via the serial communication port OR via one of the digital inputs.

8-51 Quick Stop Select		
Option:	Function:	
		Select control of the Quick Stop function via the terminals (digital input) and/or via the bus. <b>NOTE</b> This parameter is active only when <b>8-01 Control Site</b> is set to [0] Digital and control word.
[0]	Digital input	
[1]	Bus	Activates Quick stop via the serial communication port.
[2]	Logic AND	Activates Quick stop via the serial communication port, AND additionally via one of the digital inputs.
[3] *	Logic OR	Activates Quick stop via the serial communication port OR via one of the digital inputs.

8-52 DC Brake Select		
Option:	Function:	
		Select control of the DC brake via the terminals (digital input). <b>NOTE</b> This parameter is active only when <b>8-01 Control Site</b> is set to [0] Digital and control word.
[0]	Digital input	Activates DC brake via a digital input.
[1]	Bus	Activates DC brake via the serial communication port.
[2]	Logic AND	Activates DC brake via the serial communication port, AND additionally via one of the digital inputs.
[3] *	Logic OR	Activates DC brake via the serial communication port OR via one of the digital inputs.

8-53 Start Select		
Option:	Function:	
		Select control of the frequency converter start function via the terminals (digital input). <b>NOTE</b> This parameter is active only when <b>8-01 Control Site</b> is set to [0] Digital and control word.
[0]	Digital input	Activates Start command via a digital input.
[1]	Bus	Activates Start command via the serial communication port.



8-53 Start Select		
Option:	Function:	
[2]	Logic AND	Activates Start command via the serial communication port, AND additionally via one of the digital inputs.
[3] *	Logic OR	Activates Start command via the serial communication port OR via one of the digital inputs.

8-54 Reversing Select		
Option:	Function:	
		Select control of the frequency converter reverse function via the terminals (digital input) and/or via the serial communication port.  <b>NOTE</b> This parameter is active only when 8-01 Control Site is set to [0] Digital and control word.
[0] *	Digital input	Activates Reverse command via a digital input.
[1]	Bus	Activates Reverse command via the serial communication port.
[2]	Logic AND	Activates Reverse command via the serial communication port, AND additionally via one of the digital inputs.
[3]	Logic OR	Activates Reverse command via the serial communication port OR via one of the digital inputs.

8-55 Set-up Select		
Option:	Function:	
		Select control of the frequency converter set-up selection via the terminals (digital input) and/or via the serial communication port.  <b>NOTE</b> This parameter is active only when 8-01 Control Site is set to [0] Digital and control word.
[0]	Digital input	Activates the set-up selection via a digital input.
[1]	Bus	Activates the set-up selection via the serial communication port.
[2]	Logic AND	Activates the set-up selection via the serial communication port, AND additionally via one of the digital inputs.
[3] *	Logic OR	Activate the set-up selection via the serial communication port OR via one of the digital inputs.

8-56 Preset Reference Select		
Option:	Function:	
		Select control of the frequency converter Preset Reference selection via the terminals (digital input) and/or via the serial communication port.
[0]	Digital input	Activates Preset Reference selection via a digital input.
[1]	Bus	Activates Preset Reference selection via the serial communication port.
[2]	Logic AND	Activates Preset Reference selection via the serial communication port, AND additionally via one of the digital inputs.
[3] *	Logic OR	Activates the Preset Reference selection via the serial communication port OR via one of the digital inputs.

### 3.8.4 8-7\* BACnet

8-70 BACnet Device Instance		
Range:	Function:	
1 *	[0 - 0x3FFFFEUL ]	Enter a unique ID number for the BACnet device.

8-72 MS/TP Max Masters		
Range:	Function:	
127.0 *	[0.0 - 127.0 ]	Define the address of the master which holds the highest address in this network. Decreasing this value optimises polling for the token.

8-73 MS/TP Max Info Frames		
Range:	Function:	
1.0 *	[1.0 - 65534.0 ]	Define how many info/data frames the device is allowed to send while holding the token.

8-74 "I am" Service		
Option:	Function:	
[0] *	Send at power-up	
[1]	Continuously	Choose whether the device should send the "I-Am" service message only at power-up or continuously with an interval of approx. 1 min.

8-75 Intialisation Password		
Range:	Function:	
admin *	[1 - 1 ]	Enter the password needed for execution of Drive Re-initialisation.

### 3.8.5 8-8\* FC Port Diagnostics

These parameters are used for monitoring the Bus communication via the Port.

8-80 Bus Message Count		
Range:	Function:	
0.0 *	[0.0 - 65536.0 ]	This parameter shows the number of valid telegrams detected on the bus.

8-81 Bus Error Count		
Range:	Function:	
0.0 *	[0.0 - 65536.0 ]	This parameter shows the number of telegrams with faults (e.g. CRC fault), detected on the bus.

8-82 Slave Messages Rcvd		
Range:	Function:	
0.0 *	[0.0 - 65536.0 ]	This parameter shows the number of valid telegrams addressed to the slave, sent by the frequency converter.

8-83 Slave Error Count		
Range:	Function:	
0.0 *	[0.0 - 65536.0 ]	This parameter shows the number of error telegrams, which could not be executed by the frequency converter.

8-84 Slave Messages Sent		
Range:	Function:	
0.0 *	[0.0 - 65536.0 ]	This parameter shows the number of messages sent from the slave.

8-85 Slave Timeout Errors		
Range:	Function:	
0.0 *	[0.0 - 65536.0 ]	This parameter shows the number of slave timeout errors.

8-88 Reset FC port Diagnostics		
Option:	Function:	
[0] *	Do not reset	
[1]	Reset counter	

### 3.8.6 8-9\* Bus Feedback

8-94 Bus Feedback 1		
Range:	Function:	
0.0 *	[-32768.0 - 32767.0 ]	Write a feedback to this parameter via the serial communication port . This parameter must be selected in <i>20-00 Feedback 1 Source</i> as a feedback source. (Hex-value 4000h corresponds to 100% feedback / range is +/-200%)

### 3.9 Main Menu - Smart Logic - Group 13

#### 3.9.1 13-\*\* Prog. Features

Smart Logic Control (SLC) is essentially a sequence of user defined actions (see 13-52 *SL Controller Action* [x]) executed by the SLC when the associated user defined event (see 13-51 *SL Controller Event* [x]) is evaluated as TRUE by the SLC. Events and actions are each numbered and linked together in pairs. This means that when event [0] is fulfilled (attains the value TRUE), action [0] is executed. After this, the conditions of event [1] will be evaluated and if evaluated TRUE, action [1] will be executed and so on. Only one event will be evaluated at any time. If an event is evaluated as FALSE, nothing happens (in the SLC) during the current scan interval and no other events will be evaluated. This means that when the SLC starts, it evaluates event [0] (and only event [0]) each scan interval. Only when event [0] is evaluated TRUE, will the SLC execute action [0] and start evaluating event [1]. It is possible to programme from 1 to 20 events and actions. When the last event/action have been executed, the sequence starts over again from event [0]/action [0].

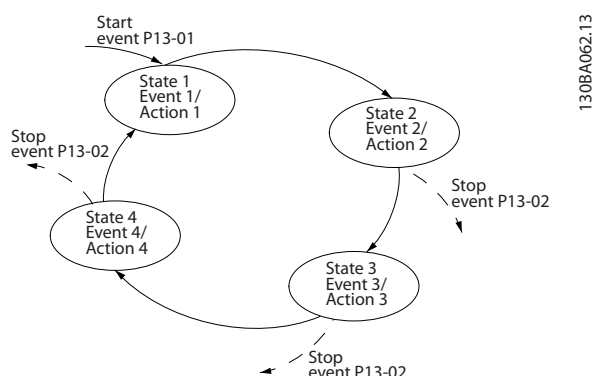

Illustration 3.1 Example with three event/actions

#### Starting and stopping the SLC:

Starting and stopping the SLC can be done by selecting *On* [1] or *Off* [0] in 13-00 *SL Controller Mode*. The SLC always starts in state 0 (where it evaluates event [0]). The SLC starts when the Start Event (defined in 13-01 *Start Event*) is evaluated as TRUE (provided that *On* [1] is selected in 13-00 *SL Controller Mode*). The SLC stops when the Stop Event (13-02 *Stop Event*) is TRUE. 13-03 *Reset SLC* resets all SLC parameters and starts programming from scratch.

#### 3.9.2 13-0\* SLC Settings

Use the SLC settings to activate, deactivate and reset the Smart Logic Control sequence. The logic functions and comparators are always running in the background, which opens for separate control of digital inputs and outputs. .

13-00 SL Controller Mode		
Option:	Function:	
		Select On [1] to enable the Smart Logic Control to start when a start command is present, e.g. via a digital input. Select Off [0] to disable the Smart Logic Control.
[0]	Off	Disables the Smart Logic Controller.
[1]	On	Enables the Smart Logic Controller.

13-01 Start Event		
Option:	Function:	
		Select the boolean (TRUE or FALSE) input to activate Smart Logic Control.
[0]	False	Enters the fixed value of FALSE in the logic rule.
[1]	True	Enters the fixed value TRUE in the logic rule.
[2]	Running	The motor is running.
[3]	In range	Motor runs within programmed current ranges (4-50 <i>Warning Current Low</i> and 4-51 <i>Warning Current High</i> )
[4]	On reference	The motor runs at reference speed.
[7]	Out of current range	The motor current is outside the range set in 4-18 <i>Current Limit</i> .
[8]	Below I low	The motor current is lower than set in 4-50 <i>Warning Current Low</i> .
[9]	Above I high	The motor current is higher than set in 4-51 <i>Warning Current High</i> .
[16]	Thermal warning	The thermal warning turns on when the temperature exceeds the limit in the motor, the frequency converter or the thermistor.
[17]	Mains out of range	
[18]	Reversing	The frequency converter is reversing.
[19]	Warning	A warning is present.
[20]	Alarm (trip)	An alarm is present.
[21]	Alarm (trip lock)	A trip lock alarm is present.
[22]	Comparator 0	Use the result of comparator 0 in the logic rule.
[23]	Comparator 1	Use the result of comparator 1 in the logic rule.
[24]	Comparator 2	Use the result of comparator 2 in the logic rule.

13-01 Start Event		
Option:	Function:	
[25]	Comparator 3	Use the result of comparator 3 in the logic rule.
[26]	Logic rule 0	Use the result of logic rule 0 in the logic rule.
[27]	Logic rule 1	Use the result of logic rule 1 in the logic rule.
[28]	Logic rule 2	Use the result of logic rule 2 in the logic rule.
[29]	Logic rule 3	Use the result of logic rule 3 in the logic rule.
[33]	Digital input DI18	Use the value of DI18 in the logic rule (High = TRUE).
[34]	Digital input DI19	Use the value of DI19 in the logic rule (High = TRUE).
[35]	Digital input DI27	Use the value of DI27 in the logic rule (High = TRUE).
[36]	Digital input DI29	Use the value of DI29 in the logic rule (High = TRUE).
[39] *	Start command	This event is TRUE if the frequency converter is started by any means (either via digital input, field bus or other).
[40]	Drive stopped	This event is TRUE if the frequency converter is stopped or coasted by any means (either via digital input, fieldbus or other).
[42]	Auto reset trip	This event is TRUE if the frequency converter is tripped (but not trip-locked) and an Automatic Reset is issued.
[50]	Comparator 4	Use the result of comparator 4 in the logic rule.
[51]	Comparator 5	Use the result of comparator 5 in the logic rule.
[60]	Logic rule 4	Use the result of logic rule 4 in the logic rule.
[61]	Logic rule 5	Use the result of logic rule 5 in the logic rule.
[83]	Broken belt	A broken belt condition has been detected. This function must be enabled in 22-60 <i>Broken Belt Function</i> .

13-02 Stop Event		
Option:	Function:	
		Select the condition (TRUE or FALSE) which will deactivate the Smart Logic Controller.
[0]	False	Enters the fixed value of FALSE in the logic rule.

13-02 Stop Event		
Option:	Function:	
[1]	True	Enters the fixed value TRUE in the logic rule.
[2]	Running	See 13-01 <i>Start Event</i> for further description.
[3]	In range	See 13-01 <i>Start Event</i> for further description.
[4]	On reference	See 13-01 <i>Start Event</i> for further description.
[7]	Out of current range	See 13-01 <i>Start Event</i> for further description.
[8]	Below I low	See 13-01 <i>Start Event</i> for further description.
[9]	Above I high	See 13-01 <i>Start Event</i> for further description.
[16]	Thermal warning	See 13-01 <i>Start Event</i> for further description.
[17]	Mains out of range	See 13-01 <i>Start Event</i> for further description.
[18]	Reversing	See 13-01 <i>Start Event</i> for further description.
[19]	Warning	See 13-01 <i>Start Event</i> for further description.
[20]	Alarm (trip)	See 13-01 <i>Start Event</i> for further description.
[21]	Alarm (trip lock)	See 13-01 <i>Start Event</i> for further description.
[22]	Comparator 0	Use the result of comparator 0 in the logic rule.
[23]	Comparator 1	Use the result of comparator 1 in the logic rule.
[24]	Comparator 2	Use the result of comparator 2 in the logic rule.
[25]	Comparator 3	Use the result of comparator 3 in the logic rule.
[26]	Logic rule 0	Use the result of logic rule 0 in the logic rule.
[27]	Logic rule 1	Use the result of logic rule 1 in the logic rule.
[28]	Logic rule 2	Use the result of logic rule 2 in the logic rule.
[29]	Logic rule 3	Use the result of logic rule 3 in the logic rule.
[30]	SL Time-out 0	Use the result of timer 0 in the logic rule.
[31]	SL Time-out 1	Use the result of timer 1 in the logic rule.
[32]	SL Time-out 2	Use the result of timer 2 in the logic rule.

13-02 Stop Event		
Option:	Function:	
[33]	Digital input DI18	Use the value of DI18 in the logic rule (High = TRUE).
[34]	Digital input DI19	
[35]	Digital input DI27	Use the value of DI27 in the logic rule (High = TRUE).
[36]	Digital input DI29	Use the value of DI29 in the logic rule (High = TRUE).
[39]	Start command	This event is TRUE if the frequency converter is started by any means (either via digital input, fieldbus or other).
[40]	Drive stopped	This event is TRUE if the frequency converter is stopped or coasted by any means (either via digital input, fieldbus or other).
[42]	Auto reset trip	This event is TRUE if the frequency converter is tripped (but not trip-locked) and an Automatic Reset is issued.
[50]	Comparator 4	Use the result of comparator 4 in the logic rule.
[51]	Comparator 5	Use the result of comparator 5 in the logic rule.
[60]	Logic rule 4	Use the result of logic rule 4 in the logic rule.
[61]	Logic rule 5	Use the result of logic rule 5 in the logic rule.
[70]	SL Time-out 3	Use the result of timer 3 in the logic rule.
[71]	SL Time-out 4	Use the result of timer 4 in the logic rule.
[72]	SL Time-out 5	Use the result of timer 5 in the logic rule.
[73]	SL Time-out 6	Use the result of timer 6 in the logic rule.
[74]	SL Time-out 7	Use the result of timer 7 in the logic rule.
[83]	Broken belt	A broken belt condition has been detected. This function must be enabled in 22-60 Broken Belt Function.

13-03 Reset SLC		
Option:	Function:	
[0] *	Do not reset SLC	Retains programmed settings in all group 13 parameters (13-*).
[1]	Reset SLC	Resets all group 13 parameters (13-*) to default settings.

### 3.9.3 13-1\* Comparators

Comparators are used for comparing continuous variables (i.e. output frequency, output current, analog input etc.) to fixed preset values.

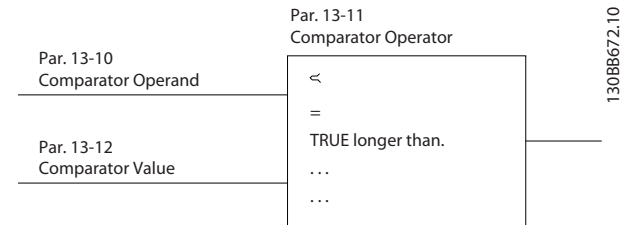

In addition, there are digital values that will be compared to fixed time values. See explanation in 13-10 *Comparator Operand*. Comparators are evaluated once in each scan interval. Use the result (TRUE or FALSE) directly. All parameters in this parameter group are array parameters with index 0 to 5. Select index 0 to programme Comparator 0, select index 1 to programme Comparator 1, and so on.

13-10 Comparator Operand		
Array [6]		
Option:	Function:	
		Select the variable to be monitored by the comparator.
[0] *	Disabled	
[1]	Reference	
[2]	Feedback	
[3]	Motor speed	
[4]	Motor current	
[6]	Motor power	
[7]	Motor voltage	
[12]	Analog input AI53	
[13]	Analog input AI54	
[20]	Alarm number	
[30]	Counter A	
[31]	Counter B	

13-11 Comparator Operator		
Array [6]		
Option:	Function:	
[0]	Less Than (<)	Select < [0] for the result of the evaluation to be TRUE, when the variable selected in 13-10 <i>Comparator Operand</i> is smaller than the fixed value in 13-12 <i>Comparator Value</i> . The result will be FALSE, if the variable selected in 13-10 <i>Comparator Operand</i> is greater than the fixed value in 13-12 <i>Comparator Value</i> .
[1] *	Approx.Equal (~)	Select ≈ [1] for the result of the evaluation to be TRUE, when the variable selected in 13-10 <i>Comparator Operand</i> is approxi-

13-11 Comparator Operator		
Array [6]		
<b>Option:</b>	<b>Function:</b>	
	mately equal to the fixed value in 13-12 Comparator Value.	
[2]	Greater Than (>)	Select > [2] for the inverse logic of option < [0].

13-12 Comparator Value		
Array [6]		
<b>Range:</b>	<b>Function:</b>	
0.0 * [-9999.0 - 9999.0 ]	Enter the 'trigger level' for the variable that is monitored by this comparator. This is an array parameter containing comparator values 0 to 5.	

### 3.9.4 13-2\*Timers

Use the result (TRUE or FALSE) from *timers* directly to define an *event* (see 13-51 *SL Controller Event*), or as boolean input in a *logic rule* (see 13-40 *Logic Rule Boolean 1*, 13-42 *Logic Rule Boolean 2* or 13-44 *Logic Rule Boolean 3*). A timer is only FALSE when started by an action (i.e. Start timer 1 [29]) until the timer value entered in this parameter is elapsed. Then it becomes TRUE again.

All parameters in this parameter group are array parameters with index 0 to 2. Select index 0 to program Timer 0, select index 1 to program Timer 1, and so on.

13-20 SL Controller Timer		
Array [8]		
<b>Range:</b>	<b>Function:</b>	
0.0 s* [0.0 - 3600.0 s]	Enter the value to define the duration of the FALSE output from the programmed timer. A timer is only FALSE if it is started by an action (see par. 13-52 [29-31] and 13-52 [70-74] Start timer X) and until the timer value has elapsed. Array par. containing timers 0 to 7.	

### 3.9.5 13-4\* Logic Rules

Combine up to three boolean inputs (TRUE / FALSE inputs) from timers, comparators, digital inputs, status bits and events using the logical operators AND, OR, and NOT. Select boolean inputs for the calculation in 13-40 *Logic Rule Boolean 1*, 13-42 *Logic Rule Boolean 2* and 13-44 *Logic Rule Boolean 3*. Define the operators used to logically combine the selected inputs in 13-41 *Logic Rule Operator 1* and 13-43 *Logic Rule Operator 2*.

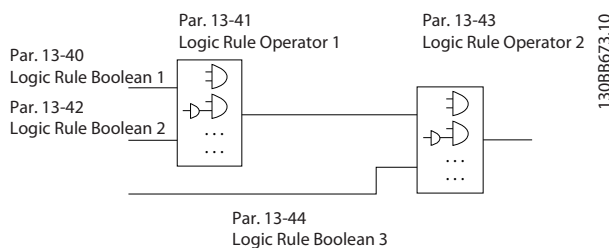

#### Priority of calculation

The results of 13-40 *Logic Rule Boolean 1*, 13-41 *Logic Rule Operator 1* and 13-42 *Logic Rule Boolean 2* are calculated first. The outcome (TRUE / FALSE) of this calculation is combined with the settings of 13-43 *Logic Rule Operator 2* and 13-44 *Logic Rule Boolean 3*, yielding the final result (TRUE / FALSE) of the logic rule.

13-40 Logic Rule Boolean 1		
Array [6]		
<b>Option:</b>	<b>Function:</b>	
[0] * False	Enters the fixed value of FALSE in the logic rule.	
[1] True	Enters the fixed value TRUE in the logic rule.	
[2] Running	See 13-01 Start Event for further description.	
[3] In range	See 13-01 Start Event for further description.	
[4] On reference	See 13-01 Start Event for further description.	
[7] Out of current range	See 13-01 Start Event for further description.	
[8] Below I low	See 13-01 Start Event for further description.	
[9] Above I high	See 13-01 Start Event for further description.	
[16] Thermal warning	See 13-01 Start Event for further description.	
[17] Mains out of range	See 13-01 Start Event for further description.	
[18] Reversing	See 13-01 Start Event for further description.	
[19] Warning	See 13-01 Start Event for further description.	
[20] Alarm (trip)	See 13-01 Start Event for further description.	
[21] Alarm (trip lock)	See 13-01 Start Event for further description.	
[22] Comparator 0	Use the result of comparator 0 in the logic rule.	

13-40 Logic Rule Boolean 1		
Array [6]		
Option:	Function:	
[23]	Comparator 1	Use the result of comparator 1 in the logic rule.
[24]	Comparator 2	Use the result of comparator 2 in the logic rule.
[25]	Comparator 3	Use the result of comparator 3 in the logic rule.
[26]	Logic rule 0	Use the result of logic rule 0 in the logic rule.
[27]	Logic rule 1	Use the result of logic rule 1 in the logic rule.
[28]	Logic rule 2	Use the result of logic rule 2 in the logic rule.
[29]	Logic rule 3	Use the result of logic rule 3 in the logic rule.
[30]	SL Time-out 0	Use the result of timer 0 in the logic rule.
[31]	SL Time-out 1	Use the result of timer 1 in the logic rule.
[32]	SL Time-out 2	Use the result of timer 2 in the logic rule.
[33]	Digital input DI18	Use the value of DI18 in the logic rule (High = TRUE).
[34]	Digital input DI19	Use the value of DI19 in the logic rule (High = TRUE).
[35]	Digital input DI27	Use the value of DI27 in the logic rule (High = TRUE).
[36]	Digital input DI29	Use the value of DI29 in the logic rule (High = TRUE).
[39]	Start command	This logic rule is TRUE if the frequency converter is started by any means (either via digital input, or other).
[40]	Drive stopped	This logic rule is TRUE if the frequency converter is stopped or coasted by any means (either via digital input, or other).
[42]	Auto reset trip	This logic rule is TRUE if the frequency converter is tripped (but not trip-locked) and an Automatic Reset is issued.
[50]	Comparator 4	Use the result of comparator 4 in the logic rule.
[51]	Comparator 5	Use the result of comparator 5 in the logic rule.
[60]	Logic rule 4	Use the result of logic rule 4 in the logic rule.
[61]	Logic rule 5	Use the result of logic rule 5 in the logic rule.

13-40 Logic Rule Boolean 1		
Array [6]		
Option:	Function:	
[70]	SL Time-out 3	Use the result of timer 3 in the logic rule.
[71]	SL Time-out 4	Use the result of timer 4 in the logic rule.
[72]	SL Time-out 5	Use the result of timer 5 in the logic rule.
[73]	SL Time-out 6	Use the result of timer 6 in the logic rule.
[74]	SL Time-out 7	Use the result of timer 7 in the logic rule.
[83]	Broken belt	A broken belt condition has been detected. This function must be enabled in <i>22-60 Broken Belt Function</i> .
[100]	Firemode	The frequency converter is operating in fire mode. See parameter group 24-0* <i>Fire Mode</i>

13-41 Logic Rule Operator 1		
Option:	Function:	
[0] *	Disabled	
[1]	AND	
[2]	OR	
[3]	AND NOT	
[4]	OR NOT	
[5]	NOT AND	
[6]	NOT OR	
[7]	NOT AND NOT	
[8]	NOT OR NOT	

13-42 Logic Rule Boolean 2		
Array [6]		
Option:	Function:	
[0] *	False	Select the second boolean (TRUE or FALSE) input for the selected logic rule.  See <i>13-40 Logic Rule Boolean 1</i> for further descriptions of choices and their functions.
[1]	True	
[2]	Running	
[3]	In range	
[4]	On reference	
[7]	Out of current range	
[8]	Below I low	
[9]	Above I high	
[16]	Thermal warning	
[17]	Mains out of range	

13-42 Logic Rule Boolean 2		
Array [6]		
Option:	Function:	
[18]	Reversing	
[19]	Warning	
[20]	Alarm (trip)	
[21]	Alarm (trip lock)	
[22]	Comparator 0	
[23]	Comparator 1	
[24]	Comparator 2	
[25]	Comparator 3	
[26]	Logic rule 0	
[27]	Logic rule 1	
[28]	Logic rule 2	
[29]	Logic rule 3	
[30]	SL Time-out 0	
[31]	SL Time-out 1	
[32]	SL Time-out 2	
[33]	Digital input DI18	
[34]	Digital input DI19	
[35]	Digital input DI27	
[36]	Digital input DI29	
[39]	Start command	
[40]	Drive stopped	
[42]	Auto reset trip	
[50]	Comparator 4	
[51]	Comparator 5	
[60]	Logic rule 4	
[61]	Logic rule 5	
[70]	SL Time-out 3	
[71]	SL Time-out 4	
[72]	SL Time-out 5	
[73]	SL Time-out 6	
[74]	SL Time-out 7	
[83]	Broken belt	A broken belt condition has been detected. This function must be enabled in 22-60 Broken Belt Function.
[100]	Firemode	The frequency converter is operating in fire mode. See parameter group 24-0* Fire Mode

13-43 Logic Rule Operator 2		
Array [6]		
Option:	Function:	
	Select the second logical operator to be used on the boolean input calculated in 13-40 Logic Rule Boolean 1, 13-41 Logic Rule Operator 1, and 13-42 Logic Rule Boolean 2, and the boolean input coming from 13-42 Logic Rule Boolean 2. [13-44] signifies the boolean input of 13-44 Logic Rule Boolean 3. [13-40/13-42] signifies the boolean input calculated in 13-40 Logic Rule Boolean 1,	

13-43 Logic Rule Operator 2		
Array [6]		
Option:	Function:	
	13-41 Logic Rule Operator 1, and 13-42 Logic Rule Boolean 2. DISABLED [0] (factory setting). select this option to ignore 13-44 Logic Rule Boolean 3.	
[0] *	Disabled	
[1]	AND	
[2]	OR	
[3]	AND NOT	
[4]	OR NOT	
[5]	NOT AND	
[6]	NOT OR	
[7]	NOT AND NOT	
[8]	NOT OR NOT	

13-44 Logic Rule Boolean 3		
Array [6]		
Option:	Function:	
	Select the third boolean (TRUE or FALSE) input for the selected logic rule.  See 13-40 Logic Rule Boolean 1 for further descriptions of choices and their functions.	
[0] *	False	
[1]	True	
[2]	Running	
[3]	In range	
[4]	On reference	
[7]	Out of current range	
[8]	Below I low	
[9]	Above I high	
[16]	Thermal warning	
[17]	Mains out of range	
[18]	Reversing	
[19]	Warning	
[20]	Alarm (trip)	
[21]	Alarm (trip lock)	
[22]	Comparator 0	
[23]	Comparator 1	
[24]	Comparator 2	
[25]	Comparator 3	
[26]	Logic rule 0	
[27]	Logic rule 1	
[28]	Logic rule 2	
[29]	Logic rule 3	
[30]	SL Time-out 0	
[31]	SL Time-out 1	
[32]	SL Time-out 2	
[33]	Digital input DI18	
[34]	Digital input DI19	



13-44 Logic Rule Boolean 3		
Array [6]		
Option:	Function:	
[35]	Digital input DI27	
[36]	Digital input DI29	
[39]	Start command	
[40]	Drive stopped	
[42]	Auto reset trip	
[50]	Comparator 4	
[51]	Comparator 5	
[60]	Logic rule 4	
[61]	Logic rule 5	
[70]	SL Time-out 3	
[71]	SL Time-out 4	
[72]	SL Time-out 5	
[73]	SL Time-out 6	
[74]	SL Time-out 7	
[83]	Broken belt	
[100]	Firemode	

### 3.9.6 13-5\* States

13-51 SL Controller Event		
Array [20]		
Option:	Function:	
		Select the boolean input (TRUE or FALSE) to define the Smart Logic Controller event.  See <i>13-02 Stop Event</i> for further descriptions of choices and their functions.
[0]	False	
[1] *	True	
[2]	Running	
[3]	In range	
[4]	On reference	
[7]	Out of current range	
[8]	Below I low	
[9]	Above I high	
[16]	Thermal warning	
[17]	Mains out of range	
[18]	Reversing	
[19]	Warning	
[20]	Alarm (trip)	
[21]	Alarm (trip lock)	
[22]	Comparator 0	
[23]	Comparator 1	
[24]	Comparator 2	
[25]	Comparator 3	
[26]	Logic rule 0	
[27]	Logic rule 1	
[28]	Logic rule 2	
[29]	Logic rule 3	

13-51 SL Controller Event		
Array [20]		
Option:	Function:	
[30]	SL Time-out 0	
[31]	SL Time-out 1	
[32]	SL Time-out 2	
[33]	Digital input DI18	
[34]	Digital input DI19	
[35]	Digital input DI27	
[36]	Digital input DI29	
[39]	Start command	
[40]	Drive stopped	
[42]	Auto reset trip	
[50]	Comparator 4	
[51]	Comparator 5	
[60]	Logic rule 4	
[61]	Logic rule 5	
[70]	SL Time-out 3	
[71]	SL Time-out 4	
[72]	SL Time-out 5	
[73]	SL Time-out 6	
[74]	SL Time-out 7	
[83]	Broken belt	

13-52 SL Controller Action		
Array [20]		
Option:	Function:	
		Select the action corresponding to the SLC event. Actions are executed when the corresponding event (defined in <i>13-51 SL Controller Event</i> ) is evaluated as true. The following actions are available for selection:
[0] *	Disabled	
[1]	No action	
[2]	Select set-up 1	Changes the active set-up (0-10 Active Set-up) to '1'.
[3]	Select set-up 2	Changes the active set-up (0-10 Active Set-up) to '2'.
[10]	Select preset ref 0	Selects preset reference 0.
[11]	Select preset ref 1	Selects preset reference 1.
[12]	Select preset ref 2	Selects preset reference 2.
[13]	Select preset ref 3	Selects preset reference 3.
[14]	Select preset ref 4	Selects preset reference 4.
[15]	Select preset ref 5	Selects preset reference 5.
[16]	Select preset ref 6	Selects preset reference 6.
[17]	Select preset ref 7	Selects preset reference 7. If the active preset reference is changed, it will merge with other preset reference commands coming from either the digital inputs or via a fieldbus.

13-52 SL Controller Action		
Array [20]		
Option:	Function:	
[18]	Select ramp 1	Selects ramp 1
[19]	Select ramp 2	Selects ramp 2
[22]	Run	Issues a start command to the frequency converter.
[23]	Run reverse	Issues a start reverse command to the frequency converter.
[24]	Stop	Issues a stop command to the frequency converter.
[25]	Qstop	Issues a quick stop command to the frequency converter.
[26]	DC Brake	Issues a DC stop command to the frequency converter.
[27]	Coast	The frequency converter coasts immediately. All stop commands including the coast command stop the SLC.
[28]	Freeze output	Freezes the output frequency of the frequency converter.
[29]	Start timer 0	Starts timer 0, see 13-20 SL Controller Timer for further description.
[30]	Start timer 1	Starts timer 1, see 13-20 SL Controller Timer for further description.
[31]	Start timer 2	Starts timer 2, see 13-20 SL Controller Timer for further description.
[32]	Set digital out A low	Any output with 'digital output 1' selected is low (off).
[33]	Set digital out B low	Any output with 'digital output 2' selected is low (off).
[34]	Set digital out C low	Any output with 'digital output 3' selected is low (off).
[35]	Set digital out D low	Any output with 'digital output 4' selected is low (off).
[38]	Set digital out A high	Any output with 'digital output 1' selected is high (closed).
[39]	Set digital out B high	Any output with 'digital output 2' selected is high (closed).
[40]	Set digital out C high	Any output with 'digital output 3' selected is high (closed).
[41]	Set digital out D high	Any output with 'digital output 4' selected is high (closed).
[60]	Reset Counter A	Resets Counter A to zero.
[61]	Reset Counter B	Resets Counter B to zero.
[70]	Start timer 3	Starts timer 3, see 13-20 SL Controller Timer for further description.

13-52 SL Controller Action		
Array [20]		
Option:	Function:	
[71]	Start timer 4	Starts timer 4, see 13-20 SL Controller Timer for further description.
[72]	Start timer 5	Starts timer 5, see 13-20 SL Controller Timer for further description.
[73]	Start timer 6	Starts timer 6, see 13-20 SL Controller Timer for further description.
[74]	Start timer 7	Starts timer 7, see 13-20 SL Controller Timer for further description.
[100]	ResetAlarm	

### 3.10 Main Menu - Special Functions - Group 14

#### 3.10.1 14-0\* Inverter Switching

14-01 Switching Frequency		
Option:	Function:	
		Select the inverter switching frequency. Changing the switching frequency can help to reduce acoustic noise from the motor.  <b>NOTE</b> The output frequency value of the frequency converter must never exceed 1/10 of the switching frequency. When the motor is running, adjust the switching frequency in 14-01 Switching Frequency until the motor is as noiseless as possible.  <b>NOTE</b> Not all choices are available in all power sizes.
[0]	Ran3	3kHz true random PWM (White noise modulation)
[1]	Ran5	5kHz true random PWM (white noise modulation)
[2]	2.0 kHz	
[3]	3.0 kHz	
[4]	4.0 kHz	
[5]	5.0 kHz	
[6]	6.0 kHz	
[7]	8.0 kHz	
[8]	10.0 kHz	
[9]	12.0kHz	
[10]	16.0kHz	

14-03 Overmodulation		
Option:	Function:	
[0]	Off	Selects no overmodulation of the output voltage in order to avoid torque ripple on the motor shaft.
[1] *	On	The over-modulation function generates an extra voltage of up-to 8% of $U_{max}$ output voltage without over-modulation, which results in an extra torque of 10-12% in the middle of the over-synchronous range (from 0% at nominal speed rising to approximately 12% at double nominal speed).

14-08 Damping Gain Factor		
Range:	Function:	
96.0 %*	[0.0 - 100.0 %]	

#### 3.10.2 14-1\* Mains On/Off

Parameters for configuring mains failure monitoring and handling.

14-12 Function at Mains Imbalance		
Option:	Function:	
		Operation under severe main imbalance conditions reduces the lifetime of the motor. Conditions are considered severe if the motor is operated continuously near nominal load (e.g. a pump or fan running near full speed). When a severe mains imbalance is detected:
[0] *	Trip	Select <i>Trip</i> [0] to trip the frequency converter.
[1]	Warning	Select <i>Warning</i> [1] to issue a warning.
[2]	Disabled	Select <i>Disabled</i> [2] for no action.
<b>CAUTION</b> May cause reduced life time.		

#### 3.10.3 14-2\* Trip Reset

14-20 Reset Mode		
Option:	Function:	
		Select the reset function after tripping. Once reset, the frequency converter can be restarted.
[0] *	Manual reset	Select <i>Manual reset</i> [0], to perform a reset via [RESET] or via the digital inputs.
[1]	Automatic reset x 1	Select <i>Automatic reset x 1...x20</i> [1]-[12] to perform between one and twenty automatic resets after tripping.
[2]	Automatic reset x 2	
[3]	Automatic reset x 3	
[4]	Automatic reset x 4	
[5]	Automatic reset x 5	
[6]	Automatic reset x 6	
[7]	Automatic reset x 7	
[8]	Automatic reset x 8	
[9]	Automatic reset x 9	
[10]	Automatic reset x 10	
[11]	Automatic reset x 15	
[12]	Automatic reset x 20	
[13]	Infinite auto reset	Select <i>Infinite Automatic Reset</i> [13] for continuous resetting after tripping.

**NOTE**

Automatic reset will also be active for resetting safe stop function.

14-21 Automatic Restart Time		
Range:		Function:
10.0 s*	[0.0 - 600.0 s]	Enter the time interval from trip to start of the automatic reset function. This parameter is active when 14-20 Reset Mode is set to Automatic reset [1] - [13].

14-22 Operation Mode		
Option:	Function:	
		Select Initialisation[2] to reset all parameter values to default.
[0] *	Normal operation	Select Normal operation [0] for normal operation of the frequency converter with the motor in the selected application.
[2]	Initialisation	Select Initialisation [2] to reset all parameter values to default settings, except for 15-03 Power Up's, 15-04 Over Temp's and 15-05 Over Volt's. The frequency converter will reset during the next power-up. 14-22 Operation Mode will also revert to the default setting Normal operation [0].

14-27 Action At Inverter Fault		
Option:	Function:	
		Select how the frequency converter should react at inverter fault. Action At Inverter Fault
[0]	Trip	
[1] *	Warning	

3.10.4 14-4\*Energy Optimising

Parameters for adjusting the energy optimisation level in both Variable Torque (VT) and Automatic Energy Optimization (AEO) mode.

Automatic Energy Optimization is only active if 1-03 Torque Characteristics, is set for Auto Energy Optim. [3].

14-40 VT Level		
Range:		Function:
90 %*	[40 - 90 %]	Enter the level of motor magnetisation at low speed. Selection of a low value reduces energy loss in the motor, but also reduces load capability. This parameter cannot be adjusted while the motor is running.

14-41 AEO Minimum Magnetisation		
Range:		Function:
66 %*	[40 - 75 %]	Enter the minimum allowable magnetisation for AEO. Selection of a low value reduces energy loss in the motor, but can also reduce resistance to sudden load changes.

3.10.5 14-5\* Environment

These parameters help the frequency converter to operate under special environmental conditions.

14-50 RFI Filter		
Option:	Function:	
[0]	Off	Select Off [0] only if the frequency converter is fed by an isolated mains source (IT mains). In this mode, the internal RFI filter capacitors between chassis and the mains RFI filter circuit are cut-out to reduce the ground capacity currents.
[1] *	On	Select On [1] to ensure that the frequency converter complies with EMC standards.

14-51 DC-Link Voltage Compensation		
Option:	Function:	
[0]	Off	Disables DC Link Compensation.
[1] *	On	Enables DC Link Compensation.

14-52 Fan Control		
Option:	Function:	
		Only valid for the following frequency converters: 380-480V, 30-90kW.
[0] *	Auto	
[4]	Auto Low Temp Env.	

14-53 Fan Monitor		
Option:	Function:	
		Select which reaction the frequency converter should take in case a fan fault is detected. (Only valid for some drive sizes.)
[0]	Disabled	
[1] *	Warning	
[2]	Trip	

14-55 Output Filter		
Option:	Function:	
		Select whether a output filter is present.
[0] *	No Filter	
[1]	Sine-Wave Filter	
[3]	Sine-Wave Filter with Feedback	

**14-63 Min Switch Frequency**

Set the minimum switch frequency allowed by the output filter.

**Range:**
**Function:**

1.0 kHz*	[1.0 - 16.0 kHz]	
----------	------------------	--

### 3.11 Main Menu - Drive Information - Group 15

Parameter group containing frequency converter information such as operating data, hardware configuration and software versions.

#### 3.11.1 15-0\* Operating Data

15-00 Operating Hours		
Range:	Function:	
0 h* h]	[0.0 - 2.147483647E9	View how many hours the frequency converter has run. The value is saved when the frequency converter is turned off.

15-01 Running Hours		
Range:	Function:	
0 h* h]	[0.0 - 2.147483647E9	View how many hours the motor has run. Reset the counter in 15-07 Reset Running Hours Counter. The value is saved when the frequency converter is turned off.

15-02 kWh Counter		
Range:	Function:	
0 kWh* kWh]	[0.0 - 65535	View the output power of the frequency converter in kWh as a mean value over one hour. Reset the counter in 15-06 Reset kWh Counter.

15-03 Power Up's		
Range:	Function:	
0 * ]	[0.0 - 2147483647 ]	View the number of times the frequency converter has been powered up.

15-04 Over Temp's		
Range:	Function:	
0 * ]	[0.0 - 65535 ]	View the number of frequency converter temperature faults which have occurred.

15-05 Over Volt's		
Range:	Function:	
0 * ]	[0.0 - 65535 ]	View the number of frequency converter overvoltages which have occurred.

15-06 Reset kWh Counter		
Option:	Function:	
[0] * ]	Do not reset	
[1]	Reset counter	Select <i>Reset</i> [1] and press [OK] to reset the kWh counter to zero (see 15-02 kWh Counter).

### NOTE

The reset is carried out by pressing [OK].

15-07 Reset Running Hours Counter		
Option:	Function:	
[0] * ]	Do not reset	
[1]	Reset counter	Select <i>Reset counter</i> [1] and press [OK] to reset Running Hours counter (15-01 Running Hours) and to zero (see also 15-01 Running Hours).

3

#### 3.11.2 15-3\* Alarm Log

Parameters in this group are array parameters, where up to 10 fault logs can be viewed. [0] is the most recent logged data, and [9] the oldest. Error codes, values, and time stamp can be viewed for all logged data.

15-30 Alarm Log: Error Code		
Range:	Function:	
0 * ]	[0.0 - 255 ]	View the error code and look up its meaning in the <i>Troubleshooting</i> chapter.

15-31 Alarm Log: Value		
Range:	Function:	
0 * ]	[-32767 - 32767]	View a description of the error. This parameter is used in combination with alarm 38 Internal Fault.

#### 3.11.3 15-4\* Drive Identification

Parameters containing read only information about the hardware and software configuration of the frequency converter.

15-40 FC Type		
Range:	Function:	
0 * ]	[0 - 0 ]	View the FC type. The read-out is identical to the frequency converter series power field of the type code definition, characters 1-6.

15-41 Power Section		
Range:	Function:	
0 * ]	[0 - 0 ]	View the FC type. The read-out is identical to the frequency converter series power field of the type code definition, characters 7-10.

15-42 Voltage		
Range:	Function:	
0 * ]	[0 - 0 ]	View the FC type. The read-out is identical to the frequency converter series power field of the type code definition, characters 11-12.

15-43 Software Version		
Range:	Function:	
0 *	[0 - 0 ]	View the software version of the frequency converter.

15-44 Ordered TypeCode		
Range:	Function:	
0 *	[0 - 0 ]	View the type code string used for re-ordering the frequency converter in its original configuration.

15-46 Drive Ordering No		
Range:	Function:	
0 *	[0 - 0 ]	View the 8-digit ordering number used for re-ordering the frequency converter in its original configuration.

15-47 Power Card Ordering No		
Range:	Function:	
0 *	[0 - 0 ]	View the power card ordering number.

15-48 LCP Id No		
Range:	Function:	
0 *	[0 - 0 ]	View the LCP ID number.

15-49 SW ID Control Card		
Range:	Function:	
0 *	[0 - 0 ]	View the control card software version number.

15-50 SW ID Power Card		
Range:	Function:	
0 *	[0 - 0 ]	View the power card software version number.

15-51 Drive Serial Number		
Range:	Function:	
0 *	[0 - 0 ]	View the frequency converter serial number.

15-53 Power Card Serial Number		
Range:	Function:	
0 *	[0 - 0 ]	View the power card serial number.

15-92 Defined Parameters		
Option:	Function:	
		View a list of all defined parameters in the frequency converter. The list ends with 0.

15-97 Application Type		
Range:	Function:	
0 *	[0 - 1 ]	

15-98 Drive Identification		
Option:	Function:	
		This parameter contains data used for the MCT-10 Setup software.

### 3.12 Main Menu - Data Readouts - Group 16

#### 3.12.1 16-0\* General Status

16-00 Control Word		
Range:	Function:	
0 *	[0 - 65535 ]	View the Control word sent from the frequency converter via the serial communication port in hex code.

Bit number															
15	14	13	12	11	10	9	8	7	6	5	4	3	2	1	0
Bit	Bit = 0							Bit = 1							
00	Preset reference choice lsb														
01	Preset reference choice second bit of preset references														
02	DC brake							Ramp							
03	Coasting							Enable							
04	Quick-stop							Ramp							
05	Freeze output							Ramp							
06	Ramp stop							Start							
07	No function							Reset							
08	No function							Jog							
09	Ramp 1							Ramp 2							
10	Data not valid							Valid							
11	Relay_A not active							Relay_A activated							
12	Relay_B not active							Relay_B activated							
13	Choice of Setup lsb														
14	No function							No function							
15	No function							Reversing							

Table 3.2 Control Word

16-01 Reference [Unit]		
Range:	Function:	
0.0 ReferenceFeed-backUnit*	[-4999.0 - 4999.0 ReferenceFeed-backUnit]	View the present reference value applied on impulse or analog basis in the unit resulting from the configuration selected in 1-00 Configuration Mode (Hz).

16-02 Reference [%]		
Range:	Function:	
0.0 %*	[-200.0 - 200.0 %]	View the total reference. The total reference is the sum of digital, analog, preset, bus, and freeze references.

16-03 Status Word		
Range:	Function:	
0 *	[0 - 65535 ]	View the Status word sent from the frequency converter via the serial communication port in hex code.

Bit number															
15	14	13	12	11	10	9	8	7	6	5	4	3	2	1	0
Bit	Bit = 0							Bit = 1							
00	Control not ready							Ready							
01	VLT not ready							Ready							
02	Coasting							Enable							
03	No fault							Trip							
04	No warning							Warning							
05	Reserved														
06	No trip lock							Trip lock							
07	No warning							Warning							
08	Speed ≠ ref.							Speed = ref.							
09	Local control							Bus control							
10	Out of range							Frequency OK							
11	Not running							Running							
12	No function														
13	Voltage OK							Above limit							
14	Current OK							Above limit							
15	Temperature OK							Above limit							

Table 3.3 Status Word

16-05 Main Actual Value [%]		
Range:	Function:	
0.0 %*	[-200.0 - 200.0 %]	View the two-byte word sent with the Status word to the bus Master reporting the Main Actual Value.

16-09 Custom Readout		
Range:	Function:	
0.0 CustomReadoutUnit*	[0.0 - 9999.0 CustomReadoutUnit]	View the user-defined readouts as defined in 0-30 Custom Readout Unit, 0-31 Custom Readout Min Value and 0-32 Custom Readout Max Value. Custom Readout

#### 3.12.2 16-1\* Motor Status

16-10 Power [kW]		
Range:	Function:	
0.00 kW*	[0.00 - 1000.00 kW]	Displays DC link power in kW. The value shown is calculated on the basis of the actual motor voltage and motor current.



16-11 Power [hp]		
Range:	Function:	
0.00 hp* [0.00 - 1000.00 hp]	View the DC link power in hp. The value shown is calculated on the basis of the actual motor voltage and motor current.	

16-12 Motor Voltage		
Range:	Function:	
0.0 V* [0.0 - 6553.0 V]	View the motor voltage, a calculated value used for controlling the motor.	

16-13 Frequency		
Range:	Function:	
0.0 Hz* [0.0 - 6553.5 Hz]	View the motor frequency, without resonance dampening.	

16-14 Motor Current		
Range:	Function:	
0.00 A* [0.00 - 655.35 A]	View the motor current measured as a mean value, IRMS.	

16-15 Frequency [%]		
Range:	Function:	
0.0 %* [0.0 - 6553.5 %]	View a two-byte word reporting the actual motor frequency (without resonance dampening) as a percentage (scale 0000-4000 Hex) of 4-19 Max Output Frequency.	

16-18 Motor Thermal		
Range:	Function:	
0.0 %* [0.0 - 100.0 %]	View the calculated motor temperature in percentage of allowed maximum. At 100% a trip will occur, if selected in 1-90 Motor Thermal Protection. The basis for the calculation is the ETR function selected in 1-90 Motor Thermal Protection.	

### 3.12.3 16-3\* Drive Status

16-30 DC Link Voltage		
Range:	Function:	
0 V* [0 - 6553.5 V]	View a measured value.	

16-34 Heatsink Temp.		
Range:	Function:	
0 C* [0 - 255 C]	View the temperature of the frequency converters heat sink.	

16-35 Inverter Thermal		
Range:	Function:	
0.0 %* [0.0 - 255.0 %]	View the percentage of thermal load on the frequency converter. At 100% a trip will occur.	

16-36 Inv. Nom. Current		
Range:	Function:	
0.0 A* [0.0 - 655.35 A]	View the inverter nominal current, which should match the nameplate data on the connected motor. The data are used for motor protection, etc.	

16-37 Inv. Max. Current		
Range:	Function:	
0.0 A* [0.0 - 655.35 A]	View the inverter maximum current. The data are used for calculation of frequency converter protection, etc.	

16-38 SL Controller State		
Range:	Function:	
0 * [0 - 255 ]	View the actual state of the Smart Logic Controller (SLC).	

### 3.12.4 16-5\* Ref. & Feedb.

16-50 External Reference		
Range:	Function:	
0.0 %* [-200.0 - 200.0 %]	View the total reference, the sum of digital, analog, preset, bus and freeze references.	

16-52 Feedback[Unit]		
Range:	Function:	
0.0 ProcessCtrlUnit* [-4999.0 - 4999.0 ProcessCtrlUnit]	View the feedback resulting from the selection of scaling in 3-02 Minimum Reference and 3-03 Maximum Reference.	

## 3.12.5 16-6\* Inputs and Outputs

16-60 Digital input		
Range:	Function:	
0 * [0 - 65535 ]	View actual state of the digital inputs 18, 19, 27 and 29.	
	<b>Bits definition</b>	
	Bit 0	Unused
	Bit 1	Unused
	Bit 2	Digital input term. 29
	Bit 3	Digital input term. 27
	Bit 4	Digital input term. 19
	Bit 5	Digital input term. 18
	Bit 6~15	Unused

16-61 Terminal 53 Setting		
Option:	Function:	
	View the setting of input terminal 53. Current = 0; Voltage = 1.	
[0] *	Current mode	
[1]	Voltage mode	

16-62 Analog Input AI53		
Range:	Function:	
1.000 * [0.000 - 20.000 ]	View the actual value at input 53.	

16-63 Terminal 54 Setting		
Option:	Function:	
	View the setting of input terminal 54. Current = 0; Voltage = 1.	
[0] *	Current mode	
[1]	Voltage mode	

16-64 Analog Input AI54		
Range:	Function:	
1.000 * [0.000 - 20.000 ]	View the actual value at input 54.	

16-65 Analog Output AO42 [mA]		
Range:	Function:	
0.000 mA* [0.000 - 20.000 mA]	View the actual value at output 42 in mA. The value shown reflects the selection in 6-90 Terminal 42 Mode and 6-91 Terminal 42 Analog Output.	

16-66 Digital Output		
Range:	Function:	
0 * [0 - 15 ]	View the binary value of all digital outputs.	
	<b>Definition:</b>	
	X: Not used	
	0: Low	
	1: High	

16-66 Digital Output		
Range:	Function:	
	XX	None used
	X0	Terminal 42 not used, Terminal 45 low
	X1	Terminal 42 not used, Terminal 45 High
	0X	Terminal 42 low, Terminal 45 not used
	0	Terminal 42 low, Terminal 45 low
	1	Terminal 42 low, Terminal 45 high
	1X	Terminal 42 high, Terminal 45 not used
	10	Terminal 42 high, Terminal 45 low
	11	Terminal 42 high, Terminal 45 high

16-71 Relay Output [bin]		
Range:	Function:	
0 * [0 - 65535 ]	View the setting of the relay.	
	<b>Bits definition:</b>	
	Bit 0~2	Unused
	Bit 3	Relay 02
	Bit 4	Relay 01
	Bit 5~15	Unused

16-72 Counter A		
Range:	Function:	
0.0 * [-32768 - 32767 ]	View the present value of Counter A. Counters are useful as comparator operands, see 13-10 Comparator Operand. The value can be reset or changed either via digital inputs (parameter group 5-1*) or by using an SLC action (13-52 SL Controller Action).	

16-73 Counter B		
Range:	Function:	
0.0 * [-32768 - 32767 ]	View the present value of Counter B. Counters are useful as comparator operands (LC-10 Comparator Operand). The value can be reset or changed either via digital inputs (parameter group 5-1*) or by using an SLC action (13-52 SL Controller Action).	

16-79 Analog Output AO45		
Range:	Function:	
0.000 mA*	[0.000 - 20.000 mA]	

### 3.12.6 16-8\* Fieldbus & FC Port

Parameters for reporting the BUS references and control words.

16-86 FC Port REF 1		
Range:	Function:	
0 *	[-32768.0 - 32767.0 ]	View the last received reference from the FC port.

### 3.12.7 16-9\* Diagnosis Read-Outs

16-90 Alarm Word		
Range:	Function:	
0.0 *	[0.0 - 0xFFFFFFFFUL ]	View the alarm word sent via the serial communication port in hex code.

16-91 Alarm Word 2		
Range:	Function:	
0.0 *	[0.0 - 0xFFFFFFFFUL ]	View the alarm word 2 sent via the serial communication port in hex code.

16-92 Warning Word		
Range:	Function:	
0.0 *	[0.0 - 0xFFFFFFFFUL ]	View the warning word sent via the serial communication port in hex code.

16-93 Warning Word 2		
Range:	Function:	
0.0 *	[0.0 - 0xFFFFFFFFUL ]	View the warning word 2 sent via the serial communication port in hex code.

16-94 Ext. Status Word		
Range:	Function:	
0.0 *	[0.0 - 0xFFFFFFFFUL ]	Returns the extended status word sent via the serial communication port in hex code.

16-95 Ext. Status Word 2		
Range:	Function:	
0.0 *	[0.0 - 0xFFFFFFFFUL ]	Returns the extended status word 2 sent via the serial communication port in hex code.

### 3.13 Main Menu - Data Readouts 2 - Group 18

Parameters in this group are array parameters, where up to 10 fault logs can be viewed. [0] is the most recent logged data, and [9] the oldest. Error codes, values, and time stamp can be viewed for all logged data

#### 3.13.1 18-1\* Fire Mode Log

18-10 FireMode Log:Event		
Range:	Function:	
0 *	[0.0 - 255 ]	View Firemode event.

### 3.14 Main Menu - FC Closed Loop - Group 20

This parameter group is used for configuring the closed loop PI Controller, that controls the output frequency of the frequency converter.

#### 3.14.1 20-0\* Feedback

This parameter group is used to configure the feedback signal for the frequency converter's closed loop PI Controller.

20-00 Feedback 1 Source		
Option:	Function:	
		This parameter defines which input will be used as the source of the feedback signal.
[0] *	No function	
[1]	Analog input 53	
[2]	Analog input 54	
[100]	Bus feedback 1	

20-01 Feedback 1 Conversion		
Option:	Function:	
		This parameter allows a conversion function to be applied to Feedback 1.
[0] *	Linear	Linear [0] has no effect on the feedback.
[1]	Square root	Square root [1] is commonly used when a pressure sensor is used to provide flow feedback (( $flow \propto \sqrt{pressure}$ )).

### 3.14.2 20-8\* PI Basic Settings

Parameters for configuring the Process PI control.

20-81 PI Normal/ Inverse Control		
Option:	Function:	
[0] *	Normal	Normal [0] causes the frequency converter's output frequency to decrease when the feedback is greater than the setpoint reference. This is common for pressure-controlled supply fan and pump applications.
[1]	Inverse	Inverse [1] causes the frequency converter's output frequency to increase when the feedback is greater than the setpoint reference. This is common for temperature-controlled cooling applications, such as cooling towers.

20-83 PI Start Speed [Hz]		
Range:	Function:	
0.0 Hz*	[0.0 - 200.0 Hz]	Enter the motor speed to be attained as a start signal for commencement of PI control. Upon power up, the frequency converter operates using speed open loop control. When the Process PI start speed is reached, the frequency converter will change to PI control.

20-84 On Reference Bandwidth		
Range:	Function:	
5.0 %*	[0.0 - 200.0 %]	Enter the On Reference bandwidth. When the PI Control Error (the difference between the reference and the feedback) is greater than the value of this parameter, then the On Reference status bit is set high, i.e. =1.

## 3.14.3 20-9\* PI Controller

20-91 PI Anti Windup		
Option:	Function:	
		Select Off [0] to continue regulation of an error even when the output frequency cannot be increased or decreased. Select On [1] to cease regulation of an error when the output frequency can no longer be adjusted.
[0]	Off	
[1] *	On	

20-93 PI Proportional Gain		
Range:	Function:	
0.01 *	[0.0 - 10.0 ]	Enter the process controller proportional gain. Quick control is obtained at high amplification. However if amplification is too great, the process may become unstable.

20-94 PI Integral Time		
Range:	Function:	
9999.0 s*	[0.1 - 9999.0 s]	Enter the process controller integral time. Obtain quick control through a short integral time, though if the integral time is too short, the process becomes unstable. An excessively long integral time disables the integral action.

20-97 PI Feed Forward Factor		
Range:	Function:	
0.0 %*	[0.0 - 400.0 %]	

### 3.15 Main Menu - Application Functions - Group 22

#### 3.15.1 22-4\* Sleep Mode

The purpose of sleep mode is to allow FC101 to stop itself in situations where the system is satisfied. This will save energy, and keeps system from being over-satisfied (too high pressure, water cooled too much in cooling towers, building pressurisation problems). This is also important for a reason that some applications cannot allow the FC101 to adjust motor down to low speed. This might damage pumps, cause insufficient lubrication in gearboxes, and make fans unstable.

Sleep controller has two important functions - ability to go to sleep at right time, and ability to come out of a sleep mode at right time. The goal is to keep FC101 in sleep mode as long as possible to avoid cycling the motor on and off frequently, and at the same time keep the controlled system variable in acceptable range.

**The sequence when running sleep mode in Open Loop:**

1. The motor speed is less than *22-47 Sleep Speed [Hz]* and the motor has been running longer than *22-40 Minimum Run Time*.
2. FC101 ramps the motor speed down to *1-82 Min Speed for Function at Stop [Hz]*.
3. FC101 activates *1-80 Function at Stop*. The frequency converter is now in sleep mode.
4. FC101 compares the speed setpoint with *22-43 Wake-Up Speed [Hz]* to detect wake up situation.
5. The speed setpoint is greater than *22-43 Wake-Up Speed [Hz]* and the sleep condition has last for more than *22-41 Minimum Sleep Time*. The frequency converter is now out of sleep mode.
6. Go back to speed open loop control (ramp motor speed up to the speed setpoint).

**The sequence when running sleep mode in Closed Loop:**

1. The motor speed is less than *22-47 Sleep Speed [Hz]* and the motor has been running longer than *22-40 Minimum Run Time*.
2. FC101 activates the boost function (add the *22-45 Setpoint Boost* to the setpoint). The frequency converter is now in sleep boost mode.
3. The new setpoint has been achieved or sleep boost has been running for longer than *22-46 Maximum Boost Time*
4. FC101 ramps the motor speed down to *1-82 Min Speed for Function at Stop [Hz]*.
5. FC101 activates *1-80 Function at Stop*. The frequency converter is now in sleep mode.

6. FC101 compares process setpoint (without boost) with feedback to detect wake up situation.
7. The error (setpoint - feedback) is greater than *22-44 Wake-Up Ref./FB Diff* and the sleep condition has last for more than *22-41 Minimum Sleep Time*. The frequency converter is now out of sleep mode.
8. FC101 goes back to closed Loop control.

**NOTE**

**Sleep Mode will not be active when Local Reference is active (set speed manually by means of arrow buttons on the LCP).**

**Does not work in Hand-mode. Auto set-up in open loop must be carried out before setting input/output in closed loop.**

22-40 Minimum Run Time		
Range:	Function:	
10.0 s*	[0.0 - 600.0 s]	Set the desired minimum running time for the motor after a start command (digital input or Bus) before entering Sleep Mode.

22-41 Minimum Sleep Time		
Range:	Function:	
10.0 s*	[0.0 - 600.0 s]	Set the desired Minimum Time for staying in Sleep Mode. This will override any wake up conditions.

22-43 Wake-Up Speed [Hz]		
Range:	Function:	
10.0 Hz*	[0.0 - 400.0 Hz]	

22-44 Wake-Up Ref./FB Diff		
Range:	Function:	
10.0 %*	[0.0 - 100.0 %]	Only to be used if <i>1-00 Configuration Mode</i> is set for Closed Loop and the integrated PI controller is used for controlling the pressure. Set the pressure drop allowed in percentage of set point for the pressure (Pset) before cancelling the Sleep Mode.

22-45 Setpoint Boost		
Range:	Function:	
0.0 %* [-100.0 - 100.0 %]	Only to be used if <i>1-00 Configuration Mode</i> , is set for Closed Loop and the integrated PI controller is used. In systems with e.g. constant pressure control, it is advantageous to increase the system pressure before the motor is stopped. This will extend the time in which the motor is stopped and help to avoid frequent start/stop. Set the desired over pressure/temperature in percentage of set point for the pressure (Pset)/temperature before entering the Sleep Mode. If setting for 5%, the boost pressure will be Pset*1.05. The negative values can be used for e.g. cooling tower control where a negative change is needed.	

22-46 Maximum Boost Time		
Range:	Function:	
60 s* [0 - 600 s]	Only to be used if <i>1-00 Configuration Mode</i> is set for Closed Loop and the integrated PI controller is used for controlling the pressure. Set the maximum time for which boost mode will be allowed. If the set time is exceeded, Sleep Mode will be entered, not waiting for the set boost pressure to be reached.	

22-47 Sleep Speed [Hz]		
Range:	Function:	
0.0 s* [0.0 - 400.0 s]	Set the speed below which the frequency converter will go into Sleep Mode.	

### 3.15.2 22-6\* Broken Belt Detection

The Broken Belt Detection can be used in both closed and open loop systems for pumps and fans. If the estimated motor torque (current) is below the broken belt torque (current) value (*22-61 Broken Belt Torque*) and the frequency converter output frequency is above or equal to 15Hz, *22-60 Broken Belt Function* is performed

22-60 Broken Belt Function		
Selects the action to be performed if the Broken Belt condition is detected.		
Option:	Function:	
[0] *	Off	
[1]	Warning	The frequency converter will continue to run, but activate a Broken Belt Warning [W95]. A drive digital output or a serial communication bus can communicate a warning to other equipment.
[2]	Trip	The frequency converter will stop running and activate a Broken Belt alarm [A 95]. A drive digital output or a serial communication bus can communicate an alarm to other equipment.

### NOTE

Do not set *14-20 Reset Mode*, to [13] Infinite auto reset, when *22-60 Broken Belt Function* is set to [2] Trip. Doing so will cause the frequency converter to continuously cycle between running and stopping when a broken belt condition is detected.

### NOTE

If the frequency converter is equipped with a constant speed bypass with an automatic bypass function that starts the bypass if the frequency converter experiences a persistent alarm condition, be sure to disable the bypass's automatic bypass function, if [2] Trip is selected as the Broken Belt Function.

22-61 Broken Belt Torque		
Range:	Function:	
10 %* [5 - 100 %]	Sets the broken belt torque as a percentage of the rated motor torque.	

22-62 Broken Belt Delay		
Range:	Function:	
10 s* [0 - 600 s]	Sets the time for which the Broken Belt conditions must be active before carrying out the action selected in <i>22-60 Broken Belt Function</i> .	

### 3.16 Main Menu - Application Functions 2 - Group 24

#### 3.16.1 24-0\* Fire Mode

#### **CAUTION**

Please note the frequency converter is only one component of the VLT HVAC Basic Drive system. Correct function of Fire Mode depends on the correct design and selection of system components. Ventilation systems working in life safety applications have to be approved by the local fire Authorities. *Non-interruption of the frequency converter due to Fire Mode operation could cause over pressure and result in damage to VLT HVAC Basic Drive system and components, hereunder dampers and air ducts. The frequency converter itself could be damaged and it may cause damage or fire. Danfoss accepts no responsibility for errors, malfunctions personal injury or any damage to the frequency converter itself or components herein, VLT HVAC Basic Drive systems and components herein or other property when the frequency converter has been programmed for Fire Mode. In no event shall Danfoss be liable to the end user or any other party for any direct or indirect, special or consequential damage or loss suffered by such party, which has occurred due to the frequency converter being programmed and operated in Fire Mode*

#### Background

Fire Mode is for use in critical situations, where it is imperative for the motor to keep running, regardless of the frequency converter's normal protective functions. These

Message	Type	LCP	Messages in display	Warning Word 2	Ext. Status Word 2
Fire Mode	Status	+	+		+(bit 25)
Fire Mode	Warning	+			
Fire M was Active	Warning	+	+	+(bit 3)	
Fire M Limits Exceeded	Warning	+	+		

#### Log

An overview of events related to Fire Mode can be viewed in the Fire Mode log, parameter group 18-1\*.

The log will include up to 10 of the latest events. Warranty Affecting Alarms will have a higher priority.

The log cannot be reset.

Following events are logged:

\*Warranty affecting alarms (see 24-09 FM Alarm Handling, Fire Mode Alarm Handling)

\*Fire Mode activated

All other alarms occurring while Fire Mode activated will be logged as usual.

#### NOTE

During Fire Mode operation all stop commands to the frequency converter will be ignored, including Coast/Coast inverse and External Interlock.

could be ventilation fans in tunnels or stairwells for instance, where continued operation of the fan facilitates safe evacuation of personnel in the event of a fire. Some selections of Fire Mode Function cause alarms and trip conditions to be disregarded, enabling the motor to run without interruption.

#### Activation

Fire Mode is activated only via Digital Input terminals. See parameter group 5-1\* Digital Inputs.

#### Messages in display

When Fire Mode is activated, the display will show a status message "Fire Mode" and a warning "Fire Mode".

Once the Fire Mode is again deactivated, the status messages will disappear and the warning will be replaced by the warning "Fire M Was Active". This message can only be reset by power-cycling the frequency converter supply. If, whilst the frequency converter is active in Fire Mode, a warranty-affecting alarm (see 24-09 FM Alarm Handling) should occur, display will show the warning "Fire M Limits Exceeded".

Digital and relay outputs can be configured for the status messages "Fire Mode Active" and the warning "Fire M Was Active". See parameter group 5-3\* and parameter group 5-4\*. "Fire M was Active" messages can also be accessed in the warning word via serial communication. (See relevant documentation).

The status messages "Fire Mode" can be accessed via the extended status word.

#### NOTE

If setting the command Start Reversing [11] on a digital input terminal in 5-10 Terminal 18 Digital Input, the FC will understand this as a reversing command.

24-00 FM Function		
Option:	Function:	
[0] *	Disabled	Fire Mode Function is not active.
[1]	Enabled-Run Forward	In this mode the motor will continue to operate in a clockwise direction.
[2]	Enabled-Run Reverse	In this mode the motor will continue to operate in a counter-clockwise direction.
[3]	Enabled-Coast	Whilst this mode is enabled, the output is disabled and the motor is allowed to coast to stop.
[4]	Enabled-Run Fwd/Rev	



**NOTE**

In the above, alarms are produced or ignored in accordance with the selection in *24-09 FM Alarm Handling*.

24-05 FM Preset Reference		
Range:	Function:	
0 Hz* [-100 - 100 Hz]	Enter the required preset reference/set point as a percentage of the Fire Mode Max Reference set in Hz.	

24-09 FM Alarm Handling		
Option:	Function:	
[1] * Trip, Crit.Alarms	In case of a critical alarm, the frequency converter will trip and not auto-restart (Manual Reset).	
[2] Trip, All Alarms/ Test	It is possible to test the operation of Fire Mode, but all alarm states are activated normally (Manual Reset).	

**NOTE**

**Warranty-affecting alarms.** Certain alarms can affect the lifetime of the frequency converter. Should one of these ignored alarms occur whilst in Fire Mode, a log of the event is stored in the Fire Mode Log.

Here the 10 latest events of warranty-affecting alarms, fire mode activation and fire mode deactivation are stored.

**NOTE**

The setting in *14-20 Reset Mode* is disregarded in case of Fire Mode being active (see parameter group *24-0\**, *Fire Mode*).

No:	Description	Critical Alarms	Warranty Affecting Alarms
4	Mains ph. Loss		x
7	DC over volt	x	
8	DC under volt	x	
9	Inverter overloaded		x
13	Over current	x	
14	Earth fault	x	
16	Short circuit	x	
29	Power card temp		x
33	Inrush fault		x
38	Internal fault		x
65	Ctrl. card temp		x

3.16.2 24-1\* Drive Bypass

The frequency converter includes a feature, which can be used to automatically activate an external electro-mechanical bypass in case of the event of a Fire Mode Coast (see *24-00 FM Function*).

The bypass will switch the motor to operation direct on line. The external bypass is activated by means of one of the digital outputs or relays in the frequency converter, when programmed in parameter group 5-3\* or parameter group 5-4\*.

**NOTE**

**The Drive Bypass cannot be deactivated if in Fire Mode. It can be deactivated only by either removing the Fire Mode command signal or the power supply to the frequency converter!**

When the Drive Bypass function is activated, the display on the LCP will show the status message Drive Bypass. This message has a higher priority than the Fire Mode status messages. When the automatic Drive Bypass function is enabled, it will cut in the external bypass according to the below sequence:

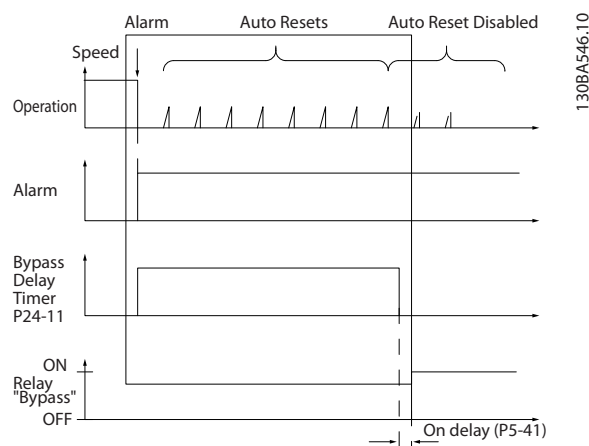

Status can be read in the Extended Status Word 2, bit number 24.

24-10 Drive Bypass Function		
Option:	Function:	
[0] *	Disabled	This parameter determines, what circumstances will activate the Drive Bypass Function:
[2]	Enabled (Fire Mode only)	The Bypass Function will operate at Trip at Critical Alarms, Coast or Bypass Delay Timer if the timer expires before reset attempts have completed.

24-11 Drive Bypass Delay Time		
Range:	Function:	
0.0 s*	[0.0 - 600.0 s]	<p>Programmable in 1 s increments. Once the Bypass Function is activated in accordance with the setting in <i>24-10 Drive Bypass Function</i>, the Bypass Delay Timer begins to operate. If the frequency converter has been set for a number of restart attempts, the timer will continue to run while the frequency converter tries to restart. Should the motor have restarted within the time period of the Bypass Delay Timer, then the timer is reset.</p> <p>Should the motor fail to restart at the end of the Bypass Delay Time, the Drive Bypass relay will be activated, which will have been programmed for Bypass in <i>5-40 Function Relay</i>.</p> <p>Where no restart attempts are programmed, the timer will run for the delay period set in this parameter and will then activate the Drive Bypass relay, which will have been programmed for Bypass in <i>5-40 Function Relay</i>, Function Relay.</p>

## 4 Troubleshooting

### 4

A warning or an alarm is signalled by the relevant LED on the front of the frequency converter and indicated by a code on the display.

A warning remains active until its cause is no longer present. Under certain circumstances operation of the motor may still be continued. Warning messages may be critical, but are not necessarily so.

In the event of an alarm, the frequency converter will have tripped. Alarms must be reset to restart operation once their cause has been rectified.

**This may be done in four ways:**

1. By using the [RESET] control button on the LCP.
2. Via a digital input with the "Reset" function.
3. Via serial communication.
4. By resetting automatically using the [Auto Reset] function, which is a default setting for VLT HVAC Basic Drive, see *14-20 Reset Mode*.

**NOTE**

After a manual reset using the [RESET] button on the LCP, the [AUTO ON] or [HAND ON] button must be pressed to restart the motor.

If an alarm cannot be reset, the reason may be that its cause has not been rectified, or the alarm is trip-locked (see also table on following page).

**CAUTION**

Alarms that are trip-locked offer additional protection, means that the mains supply must be switched off before the alarm can be reset. After being switched back on, the frequency converter is no longer blocked and may be reset as described above once the cause has been rectified.

Alarms that are not trip-locked can also be reset using the automatic reset function in *14-20 Reset Mode* (Warning: automatic wake-up is possible!)

If a warning and alarm is marked against a code in the table on the following page, this means that either a warning occurs before an alarm, or it can be specified whether it is a warning or an alarm that is to be displayed for a given fault. This is possible, for instance, in *1-90 Motor Thermal Protection*. After an alarm or trip, the motor carries on coasting, and the alarm and warning flash on the frequency converter. Once the problem has been rectified, only the alarm continues flashing.

No.	Description	Warning	Alarm	Trip Lock	Parameter Reference
2	Live zero error	(X)	(X)		6-01
3	No motor	(X)			1-80
4	Mains phase loss	(X)	(X)	(X)	14-12
7	DC over voltage	X	X		
8	DC under voltage	X	X		
9	Inverter overloaded	X	X		
10	Motor ETR over temperature	(X)	(X)		1-90
11	Motor thermistor over temperature	(X)	(X)		1-90
13	Over Current	X	X	X	
14	Earth fault	X	X	X	
16	Short Circuit		X	X	
17	Control word timeout	(X)	(X)		8-04
24	Fan Fault (Only on 400V 30-90kW)	X	X		14-53
30	Motor phase U missing		(X)	(X)	4-58
31	Motor phase V missing		(X)	(X)	4-58
32	Motor phase W missing		(X)	(X)	4-58
38	Internal fault		X	X	
44	Earth fault 2		X	X	
47	Control Voltage Fault		X	X	
48	VDD1 Supply Low		X	X	
50	AMA Calibration Failed		X		
51	AMA check U <sub>nom</sub> and I <sub>nom</sub>		X		
52	AMA low I <sub>nom</sub>		X		

No.	Description	Warning	Alarm	Trip Lock	Parameter Reference
53	AMA motor too big		X		
54	AMA motor too small		X		
55	AMA Parameter out of range		X		
56	AMA interrupted by user		X		
57	AMA timeout		X		
58	AMA internal fault	X	X		
59	Current limit	X			
60	External Interlock		X		
66	Heat sink Temperature Low	X			
69	Pwr Card Temperature	X	X	X	
79	Illegal PS config	X	X		
80	Drive Initialized to Default Value		X		
87	Auto DC Braking	X			
95	Broken Belt	X	X		22-6*
201	Fire Mode	X			
202	Fire M Limits Exceeded	X			
250	New spare parts		X	X	
251	New Type Code		X	X	

**Table 4.1 Alarm/Warning code list**

(X) Dependent on parameter

A trip is the action when an alarm has appeared. The trip will coast the motor and can be reset by pressing the reset button or make a reset by a digital input (parameter group 5-1\* [1]). The original event that caused an alarm cannot damage the frequency converter or cause dangerous conditions. A trip lock is an action when an alarm occurs, which may cause damage to frequency converter or connected parts. A Trip Lock situation can only be reset by a power cycling.

LED indication	
Warning	yellow
Alarm	flashing red

The alarm words, warning words and extended status words can be read out via serial bus or optional fieldbus for diagnosis. See also *16-90 Alarm Word*, *16-92 Warning Word* and *16-94 Ext. Status Word*.

4.1.1 Alarm Words

Bit	Hex	Dec	16-90 Alarm Word	16-91 Alarm Word 2
0	1	1	0	0
1	2	2	Pwr.Card Temp	0
2	4	4	Earth Fault	ServiceTrip, Typecode
3	8	8	0	Sparepart
4	10	16	Ctrl. Word TO	0
5	20	32	Over Current	0
6	40	64	0	0
7	80	128	Motor Th. Over	0
8	100	256	Motor ETR Over	Broken Belt
9	200	512	Inverter Overld.	0
10	400	1024	DC under Volt	0
11	800	2048	DC over Volt.	0
12	1000	4096	Short Circuit	External Interlock
13	2000	8192	0	0
14	4000	16384	Mains ph. loss	0
15	8000	32768	AMA Not OK	0
16	10000	65536	Live Zero Error	0
17	20000	131072	Internal Fault	0
18	40000	262144	0	Fans error
19	80000	524288	U phase Loss	0
20	100000	1048576	V phase Loss	0
21	200000	2097152	W phase Loss	0
22	400000	4194304	0	0
23	800000	8388608	Control Voltage Fault	0
24	1000000	16777216	0	0
25	2000000	33554432	VDD1 Supply Low	0
26	4000000	67108864	0	0
27	8000000	134217728	0	0
28	10000000	268435456	Earth fault	0
29	20000000	536870912	Drive Initialized	0
30	40000000	1073741824	0	0
31	80000000	2147483648	0	0

4.1.2 Warning Words

Bit	Hex	Dec	16-92 Warning Word	16-93 Warning Word 2
0	1	1	0	0
1	2	2	Pwr.Card Temp	0
2	4	4	Earth Fault	0
3	8	8	0	0
4	10	16	Ctrl. Word TO	0
5	20	32	Over Current	0
6	40	64	0	0
7	80	128	Motor Th. Over	0
8	100	256	Motor ETR Over	Broken Belt
9	200	512	Inverter Overld.	0
10	400	1024	DC under Volt	0
11	800	2048	DC over Volt.	0
12	1000	4096	0	0
13	2000	8192	0	0
14	4000	16384	Mains ph. loss	0
15	8000	32768	No motor	Auto DC Braking
16	10000	65536	Live Zero Error	0
17	20000	131072	0	0
18	40000	262144	0	Fans warning
19	80000	524288	0	0
20	100000	1048576	0	0
21	200000	2097152	0	0
22	400000	4194304	0	0
23	800000	8388608	0	0
24	1000000	16777216	0	0
25	2000000	33554432	Current Limit	0
26	4000000	67108864	Low temp.	0
27	8000000	134217728	0	0
28	10000000	268435456	0	0
29	20000000	536870912	0	0
30	40000000	1073741824	0	0
31	80000000	2147483648	0	0

### 4.1.3 Extended Status Words

Bit	Hex	Dec	16-94 Ext. Status Word	16-95 Ext. Status Word 2
0	1	1	Ramping	Off
1	2	2	AMA running	Hand/Auto
2	4	4	Start CW/CCW	0
3	8	8	0	0
4	10	16	0	0
5	20	32	0	Relay 12 active
6	40	64	0	0
7	80	128	Output current high	Control Ready
8	100	256	Output current low	Drive Ready
9	200	512	0	Quick Stop
10	400	1024	0	DC Brake
11	800	2048	0	Stop
12	1000	4096	0	0
13	2000	8192	Braking	Freeze Output Request
14	4000	16384	0	Freeze Output
15	8000	32768	OVC active	Jog Request
16	10000	65536	AC brake	Jog
17	20000	131072	0	Start request
18	40000	262144	0	Start
19	80000	524288	0	0
20	100000	1048576	0	Start Delay
21	200000	2097152	Local Ref./ Remote Ref.	Sleep
22	400000	4194304	0	Sleep boost
23	800000	8388608	0	Running
24	1000000	16777216	0	Bypass
25	2000000	33554432	0	Fire Mode
26	4000000	67108864	0	External Interlock
27	8000000	134217728	0	Firemodelimitexceed
28	10000000	268435456	0	FlyStart Active
29	20000000	536870912	0	0
30	40000000	1073741824	0	0
31	80000000	2147483648	Database busy	0

### 4.1.4 Fault Messages

#### WARNING/ALARM 2, Live zero error

This warning or alarm will only appear if programmed by the user in *6-01 Live Zero Timeout Function*. The signal on one of the analog inputs is less than 50% of the minimum value programmed for that input. This condition can be caused by broken wiring or faulty device sending the signal.

#### Troubleshooting:

Check connections on all the analog input terminals. Control card terminals 53 and 54 for signals, terminal 55 common.

Check that the drive programming match the analog signal type.

**WARNING/ALARM 4, Mains phase loss** A phase is missing on the supply side, or the mains voltage imbalance is too high. This message also appears for a fault in the input rectifier on the frequency converter. Options are programmed at *14-12 Function at Mains Imbalance*.

**Troubleshooting:** Check the supply voltage and supply currents to the frequency converter.

#### WARNING/ALARM 7, DC overvoltage

If the intermediate circuit voltage exceeds the limit, the frequency converter trips after a time.

#### Troubleshooting:

Extend the ramp time

Activate functions in *2-10 Brake Function*

#### WARNING/ALARM 8, DC under voltage

If the intermediate circuit voltage (DC) drops below the under voltage limit, the frequency converter trips after a fixed time delay. The time delay varies with unit size.

#### Troubleshooting:

Check that the supply voltage matches the frequency converter voltage.

Perform Input voltage test

#### WARNING/ALARM 9, Inverter overloaded

The frequency converter is about to cut out because of an overload (too high current for too long). The counter for electronic, thermal inverter protection gives a warning at 90% and trips at 100%, while giving an alarm. The frequency converter *cannot* be reset until the counter is below 90%. The fault is that the frequency converter is overloaded by more than 100% for too long.

#### Troubleshooting:

Compare the output current shown on the LCP with the drive rated current.

Compare the output current shown on the LCP with measured motor current.

Display the Thermal Drive Load on the LCP and monitor the value. When running above the drive continuous current rating, the counter should increase. When running below the drive continuous current rating, the counter should decrease.

## NOTE

See the derating section in the Design Guide for more details if a high switching frequency is required.

### WARNING/ALARM 10, Motor overload temperature

According to the electronic thermal protection (ETR), the motor is too hot. Select whether the frequency converter gives a warning or an alarm when the counter reaches 100% in *1-90 Motor Thermal Protection*. The fault is that the motor is overloaded by more than 100% for too long.

#### Troubleshooting:

Check if motor is over heating.

If the motor is mechanically overloaded

That the motor *1-24 Motor Current* is set correctly.

Motor data in parameters 1-20 through 1-25 are set correctly.

Run *AMA* in *1-29 Automatic Motor Adaption (AMA)*.

### WARNING/ALARM 11, Motor thermistor over temp

The thermistor or the thermistor connection is disconnected. Select whether the frequency converter gives a warning or an alarm in *1-90 Motor Thermal Protection*.

#### Troubleshooting:

Check if motor is over heating.

Check if the motor is mechanically overloaded.

Check that the thermistor is connected correctly.

If using a thermal switch or thermistor, check the programming of *1-93 Thermistor Source* matches sensor wiring.

### WARNING/ALARM 13, Over current

The inverter peak current limit is exceeded. The warning lasts about 1.5 sec., then the frequency converter trips and issues an alarm.

#### Troubleshooting:

This fault may be caused by shock loading or fast acceleration with high inertia loads.

Turn off the frequency converter. Check if the motor shaft can be turned.

Check that the motor size matches the frequency converter.

Incorrect motor data in parameters 1-20 through 1-25.

### ALARM 14, Earth (ground) fault

There is a discharge from the output phases to earth, either in the cable between the frequency converter and the motor or in the motor itself.

#### Troubleshooting:

Turn off the frequency converter and remove the earth fault.

Measure the resistance to ground of the motor leads and the motor with a megohmmeter to check for earth faults in the motor.

### ALARM 16, Short circuit

There is short-circuiting in the motor or on the motor terminals.

Turn off the frequency converter and remove the short-circuit.

### WARNING/ALARM 17, Control word timeout

There is no communication to the frequency converter. The warning will only be active when *8-04 Control Timeout Function* is NOT set to OFF.

If *8-04 Control Timeout Function* is set to *Stop* and *Trip*, a warning appears and the frequency converter ramps down until it trips, while giving an alarm.

#### Troubleshooting:

Check connections on the serial communication cable.

Increase *8-03 Control Timeout Time*

Check operation of the communication equipment.

Verify proper installation based on EMC requirements.

### WARNING 24, Fan fault

The fan warning function is an extra protection function that checks if the fan is running / mounted. The fan warning can be disabled in *14-53 Fan Monitor* ([0] Disabled).

#### Troubleshooting:

Check fan resistance.

### ALARM 30, Motor phase U missing

Motor phase U between the frequency converter and the motor is missing.

Turn off the frequency converter and check motor phase U.

### ALARM 31, Motor phase V missing

Motor phase V between the frequency converter and the motor is missing.

Turn off the frequency converter and check motor phase V.

**ALARM 32, Motor phase W missing**

Motor phase W between the frequency converter and the motor is missing.

Turn off the frequency converter and check motor phase W.

**ALARM 38, Internal fault**

It may be necessary to contact your Danfoss supplier.

**ALARM 44, Earth fault II**

There is a discharge from the output phases to earth, either in the cable between the frequency converter and the motor or in the motor itself.

**Troubleshooting**

Turn off the frequency converter and remove the earth fault.

Measure the resistance to ground of the motor leads and the motor with a megohmmeter to check for earth fault in the motor.

**WARNING 47, Control Voltage Fault****WARNING 48, VDD1 Supply Low**

The VDD1 supply on the control card is outside of allowable limits.

**ALARM 51, AMA check Unom and Inom**

The setting of motor voltage, motor current, and motor power is presumably wrong. Check the settings.

**ALARM 52, AMA low Inom**

The motor current is too low. Check the settings.

**ALARM 53, AMA motor too big**

The motor is too big for the AMA to be carried out.

**ALARM 54, AMA motor too small**

The motor is too small for the AMA to be carried out.

**ALARM 55, AMA Parameter out of range**

The parameter values found from the motor are outside acceptable range.

**ALARM 56, AMA interrupted by user**

The AMA has been interrupted by the user.

**ALARM 57, AMA timeout**

Try to start the AMA again a number of times, until the AMA is carried out. Please note that repeated runs may heat the motor to a level where the resistance  $R_s$  and  $R_r$  are increased. In most cases, however, this is not critical.

**ALARM 58, AMA internal fault**

Contact your Danfoss supplier.

**WARNING 59, Current limit**

The current is higher than the value in *4-18 Current Limit*.

**WARNING 60, External interlock**

External interlock has been activated. To resume normal operation, apply 24V DC to the terminal programmed for external interlock and reset the frequency converter (via serial communication, digital I/O, or by pressing reset button on keypad).

**WARNING 66, Heatsink temperature low**

This warning is based on the temperature sensor in the IGBT module.

**Troubleshooting:**

The heatsink temperature measured as 0° C could indicate that the temperature sensor is defective causing the fan speed to increase to the maximum. If the sensor wire between the IGBT and the gate drive card is disconnected, this warning would result. Also, check the IGBT thermal sensor.

**ALARM 79, Illegal power section configuration****ALARM 80, Drive initialized to default value**

Parameter settings are initialized to default settings after a manual reset.

**ALARM 95, Broken belt**

Torque is below the torque level set for no load, indicating a broken belt. See parameter group 22-6\*.

**WARNING 200, Fire Mode**

Fire Mode has been activated.

**WARNING 202, Fire Mode Limits Exceeded**

Fire Mode has suppressed one or more warranty voiding alarms.

**WARNING 205, New Spare Part**

The power or switch mode power supply has been exchanged.

**WARNING 251, New Type Code**

The frequency converter has a new type code.



## 5 Parameter Lists

### 5.1 Parameter Options

#### 5.1.1 Default settings

Changes during operation:

"TRUE" means that the parameter can be changed while the frequency converter is in operation and "FALSE" means that the frequency converter must be stopped before a change can be made.

2-Set-up:

'All set-up': the parameter can be set individually in each of the two set-ups, i.e. one single parameter can have two different data values.

'1 set-up': data value will be the same in all set-ups.

ExpressionLimit:

Size related

N/A:

No default value available.

Conversion index:

This number refers to a conversion figure used when writing or reading by means of a frequency converter.

<b>Conv. index</b>	100	75	74	70	67	6	5	4	3	2	1	0	-1	-2	-3	-4	-5	-6
<b>Conv. factor</b>	1	3600000	3600	60	1/60	100000 0	10000 0	10000	1000	100	10	1	0.1	0.01	0.001	0.000 1	0.00001	0.00000 1

Data type	Description	Type
2	Integer 8	Int8
3	Integer 16	Int16
4	Integer 32	Int32
5	Unsigned 8	UInt8
6	Unsigned 16	UInt16
7	Unsigned 32	UInt32
9	Visible String	VisStr
33	Normalized value 2 bytes	N2
35	Bit sequence of 16 boolean variables	V2

## 5.1.2 0-\*\* Operation / Display

Par. No. #	Parameter description	Default value	2-set-up	Change during operation	Conversion index	Type
<b>0-0* Basic Settings</b>						
0-01	Language	[0] English	1 set-up	TRUE	-	UInt8
0-03	Regional Settings	ExpressionLimit	1 set-up	FALSE	-	UInt8
0-04	Operating State at Power-up	[0] Resume	All set-ups	TRUE	-	UInt8
0-06	GridType	ExpressionLimit	1 set-up	FALSE	-	UInt8
0-07	Auto DC Braking IT	[0] Off	1 set-up	FALSE	-	UInt8
<b>0-1* Set-up Operations</b>						
0-10	Active Set-up	[1] Set-up 1	1 set-up	TRUE	-	UInt8
0-11	Programming Set-up	[9] Active Set-up	1 set-up	TRUE	-	UInt8
0-12	Link Setups	[20] Linked	All set-ups	FALSE	-	UInt8
<b>0-3* LCP Custom Readout</b>						
0-30	Custom Readout Unit	[1] %	1 set-up	TRUE	-	UInt8
0-31	Custom Readout Min Value	0.0 CustomReadoutUnit	1 set-up	TRUE	-2	Int32
0-32	Custom Readout Max Value	100.0 CustomReadoutUnit	1 set-up	TRUE	-2	Int32
0-37	Display Text 1	0 N/A	1 set-up	TRUE	0	VisStr[2 1]
0-38	Display Text 2	0 N/A	1 set-up	TRUE	0	VisStr[2 6]
0-39	Display Text 3	0 N/A	1 set-up	TRUE	0	VisStr[2 6]
<b>0-4* LCP Keypad</b>						
0-40	[Hand on] Key on LCP	[1] Enable All	All set-ups	TRUE	-	UInt8
0-42	[Auto on] Key on LCP	[1] Enable All	All set-ups	TRUE	-	UInt8
0-44	[Off / Reset] Key on LCP	[1] Enable All	All set-ups	TRUE	-	UInt8
<b>0-5* Copy/Save</b>						
0-50	LCP Copy	[0] No copy	1 set-up	FALSE	-	UInt8
0-51	Set-up Copy	[0] No copy	1 set-up	FALSE	-	UInt8
<b>0-6* Password</b>						
0-60	Main Menu Password	0 N/A	1 set-up	TRUE	0	uint_16

## 5.1.3 1-\*\* Load and Motor

5

Par. No. #	Parameter description	Default value	2-set-up	Change during operation	Conversion index	Type
<b>1-0* General Settings</b>						
1-00	Configuration Mode	[0] Open Loop	All set-ups	TRUE	-	Uint8
1-01	Motor Control Principle	[1] VVC+	All set-ups	FALSE	-	Uint8
1-03	Torque Characteristics	[1] Variable Torque	All set-ups	FALSE	-	Uint8
1-06	Clockwise Direction	[0] Normal	All set-ups	FALSE	-	Uint8
<b>1-2* Motor Data</b>						
1-20	Motor Power	ExpressionLimit	All set-ups	FALSE	-	Uint8
1-22	Motor Voltage	ExpressionLimit	All set-ups	FALSE	0	Uint16
1-23	Motor Frequency	ExpressionLimit	All set-ups	FALSE	0	uint_16
1-24	Motor Current	ExpressionLimit	All set-ups	FALSE	-2	uint_32
1-25	Motor Nominal Speed	ExpressionLimit	All set-ups	FALSE	67	uint_16
1-29	Automatic Motor Adaption (AMA)	[0] Off	All set-ups	FALSE	-	Uint8
<b>1-3* Adv. Motor Data I</b>						
1-30	Stator Resistance (Rs)	ExpressionLimit	All set-ups	FALSE	-3	Uint32
1-33	Stator Leakage Reactance (X1)	ExpressionLimit	All set-ups	FALSE	-3	uint_32
1-35	Main Reactance (Xh)	ExpressionLimit	All set-ups	FALSE	-2	uint_32
1-39	Motor Poles	4.0 N/A	All set-ups	FALSE	0	uint_8
<b>1-4* Adv. Motor Data II</b>						
1-42	Motor Cable Length	50.0 m	All set-ups	FALSE	0	uint_8
1-43	Motor Cable Length Feet	144.0 m	All set-ups	FALSE	0	uint_16
<b>1-5* Load Indep. Setting</b>						
1-50	Motor Magnetisation at Zero Speed	100.0 %	All set-ups	TRUE	0	uint_16
1-52	Min Speed Normal Magnetising [Hz]	0.0 Hz	All set-ups	TRUE	-1	uint_16
1-55	U/f Characteristic - U	ExpressionLimit	All set-ups	FALSE	-1	uint_16
1-56	U/f Characteristic - F	ExpressionLimit	All set-ups	FALSE	-1	uint_16
<b>1-6* Load Depen. Setting</b>						
1-62	Slip Compensation	0 %	All set-ups	TRUE	0	Int16
1-63	Slip Compensation Time Constant	0.1 s	All set-ups	TRUE	-2	uint_16
1-64	Resonance Dampening	100.0 %	All set-ups	TRUE	0	uint_16
1-65	Resonance Dampening Time Constant	0.0050 %	All set-ups	TRUE	-3	uint_16
<b>1-7* Start Adjustments</b>						
1-71	Start Delay	0.0 s	All set-ups	TRUE	-1	uint_8
1-72	Start Function	[2] Coast/delay time	All set-ups	TRUE	-	Uint8
1-73	Flying Start	[0] Disabled	All set-ups	FALSE	-	Uint8
<b>1-8* Stop Adjustments</b>						
1-80	Function at Stop	[0] Coast	All set-ups	TRUE	-	Uint8
1-82	Min Speed for Function at Stop [Hz]	0.0 Hz	All set-ups	TRUE	-1	uint_16
<b>1-9* Motor Temperature</b>						
1-90	Motor Thermal Protection	[0] No protection	All set-ups	TRUE	-	Uint8
1-93	Thermistor Source	[0] None	All set-ups	FALSE	-	Uint8

## 5.1.4 2-\*\* Brakes

Par. No. #	Parameter description	Default value	2-set-up	Change during operation	Conversion index	Type
<b>2-0* DC-Brake</b>						
2-00	DC Hold/Motor Preheat Current	50.0 %	All set-ups	TRUE	0	uint_16
2-01	DC Brake Current	50.0 %	All set-ups	TRUE	0	uint_16
2-02	DC Braking Time	10.0 s	All set-ups	TRUE	-1	uint_16
2-04	DC Brake Cut In Speed	0.0 Hz	All set-ups	TRUE	-1	uint_16
<b>2-1* Brake Energy Funct.</b>						
2-16	AC Brake, Max current	100.0 %	All set-ups	TRUE	-1	Uint16
2-17	Over-voltage Control	[2] Enabled	All set-ups	TRUE	-	Uint8

## 5.1.5 3-\*\* Reference/Ramps

Par. No. #	Parameter description	Default value	2-set-up	Change during operation	Conversion index	Type
<b>3-0* Reference Limits</b>						
3-02	Minimum Reference	0.0 ReferenceFeedbackUnit	All set-ups	TRUE	-3	Int32
3-03	Maximum Reference	50.0 ReferenceFeedbackUnit	All set-ups	TRUE	-3	Int32
<b>3-1* References</b>						
3-10	Preset Reference	0.0 %	All set-ups	TRUE	-2	Int16
3-11	Jog Speed [Hz]	5.0 Hz	All set-ups	TRUE	-1	uint_16
3-14	Preset Relative Reference	0.0 %	All set-ups	TRUE	-2	Int16
3-15	Reference 1 Source	[1] Analog in 53	All set-ups	TRUE	-	Uint8
3-16	Reference 2 Source	[2] Analog in 54	All set-ups	TRUE	-	Uint8
3-17	Reference 3 Source	[11] Local bus reference	All set-ups	TRUE	-	Uint8
<b>3-4* Ramp 1</b>						
3-41	Ramp 1 Ramp up Time	ExpressionLimit	All set-ups	TRUE	-2	uint_32
3-42	Ramp 1 Ramp Down Time	ExpressionLimit	All set-ups	TRUE	-2	uint_32
<b>3-5* Ramp 2</b>						
3-51	Ramp 2 Ramp up Time	ExpressionLimit	All set-ups	TRUE	-2	uint_32
3-52	Ramp 2 Ramp down Time	ExpressionLimit	All set-ups	TRUE	-2	uint_32
<b>3-8* Other Ramps</b>						
3-80	Jog Ramp Time	ExpressionLimit	All set-ups	TRUE	-2	uint_32
3-81	Quick Stop Ramp Time	ExpressionLimit	1 set-up	TRUE	-2	uint_32

## 5.1.6 4-\*\* Limits/Warnings

Par. No. #	Parameter description	Default value	2-set-up	Change during operation	Conversion index	Type
<b>4-1* Motor Limits</b>						
4-10	Motor Speed Direction	[2] Both directions	All set-ups	FALSE	-	Uint8
4-12	Motor Speed Low Limit [Hz]	0.0 Hz	All set-ups	FALSE	-1	uint_16
4-14	Motor Speed High Limit [Hz]	65.0 Hz	All set-ups	FALSE	-1	Uint16
4-18	Current Limit	110.0 %	All set-ups	TRUE	0	uint_16
4-19	Max Output Frequency	65.0 Hz	All set-ups	FALSE	-1	Uint16
<b>4-5* Adj. Warnings</b>						
4-50	Warning Current Low	0.00 A	All set-ups	TRUE	-2	uint_32
4-51	Warning Current High	194.00 A	All set-ups	TRUE	-2	uint_32
4-58	Missing Motor Phase Function	[1] On	All set-ups	FALSE	-	Uint8
<b>4-6* Speed Bypass</b>						
4-61	Bypass Speed From [Hz]	0.0 Hz	All set-ups	TRUE	-1	uint_16
4-63	Bypass Speed To [Hz]	0.0 Hz	All set-ups	TRUE	-1	uint_16
4-64	Semi-Auto Bypass Set-up	[0] Off	All set-ups	TRUE	-	Uint8

## 5.1.7 5-\*\* Digital In/Out

Par. No. #	Parameter description	Default value	2-set-up	Change during operation	Conversion index	Type
<b>5-0* Digital I/O mode</b>						
5-00	Digital Input Mode	[0] PNP	1 set-up	FALSE	-	Uint8
5-03	Digital Input 29 Mode	[0] PNP	1 set-up	FALSE	-	Uint8
<b>5-1* Digital Inputs</b>						
5-10	Terminal 18 Digital Input	[8] Start	All set-ups	TRUE	-	Uint8
5-11	Terminal 19 Digital Input	[0] No operation	All set-ups	TRUE	-	Uint8
5-12	Terminal 27 Digital Input	[2] Coast inverse	All set-ups	TRUE	-	Uint8
5-13	Terminal 29 Digital Input	[14] Jog	All set-ups	TRUE	-	Uint8
<b>5-4* Relays</b>						
5-40	Function Relay	ExpressionLimit	All set-ups	TRUE	-	Uint8
<b>5-9* Bus Controlled</b>						
5-90	Digital & Relay Bus Control	0.0 N/A	All set-ups	TRUE	0	uint_32

## 5.1.8 6-\*\* Analog In/Out

Par. No. #	Parameter description	Default value	2-set-up	Change during operation	Conversion index	Type
<b>6-0* Analog I/O Mode</b>						
6-00	Live Zero Timeout Time	10.0 s	All set-ups	TRUE	0	uint_8
6-01	Live Zero Timeout Function	[0] Off	All set-ups	TRUE	-	Uint8
<b>6-1* Analog Input 53</b>						
6-10	Terminal 53 Low Voltage	0.07 V	All set-ups	TRUE	-2	uint_16
6-11	Terminal 53 High Voltage	10.0 V	All set-ups	TRUE	-2	uint_16
6-12	Terminal 53 Low Current	4.0 mA	All set-ups	TRUE	-2	uint_16
6-13	Terminal 53 High Current	20.0 mA	All set-ups	TRUE	-2	uint_16
6-14	Terminal 53 Low Ref./Feedb. Value	0.0 N/A	All set-ups	TRUE	-3	Int32
6-15	Terminal 53 High Ref./Feedb. Value	50.0 N/A	All set-ups	TRUE	-3	Int32
6-16	Terminal 53 Filter Time Constant	0.01 s	All set-ups	TRUE	-2	uint_16
6-19	Terminal 53 mode	[1] Voltage mode	1 set-up	TRUE	-	Uint8
<b>6-2* Analog Input 54</b>						
6-20	Terminal 54 Low Voltage	0.07 V	All set-ups	TRUE	-2	uint_16
6-21	Terminal 54 High Voltage	10.0 V	All set-ups	TRUE	-2	uint_16
6-22	Terminal 54 Low Current	4.0 mA	All set-ups	TRUE	-2	uint_16
6-23	Terminal 54 High Current	20.0 mA	All set-ups	TRUE	-2	uint_16
6-24	Terminal 54 Low Ref./Feedb. Value	0.0 N/A	All set-ups	TRUE	-3	Int32
6-25	Terminal 54 High Ref./Feedb. Value	50.0 N/A	All set-ups	TRUE	-3	Int32
6-26	Terminal 54 Filter Time Constant	0.01 s	All set-ups	TRUE	-2	uint_16
6-29	Terminal 54 mode	[1] Voltage mode	1 set-up	TRUE	-	Uint8
<b>6-7* Analog/Digital Output 45</b>						
6-70	Terminal 45 Mode	[0] 0-20 mA	All set-ups	TRUE	-	Uint8
6-71	Terminal 45 Analog Output	[0] No operation	All set-ups	TRUE	-	Uint8
6-72	Terminal 45 Digital Output	[0] No operation	All set-ups	TRUE	-	Uint8
6-73	Terminal 45 Output Min Scale	0.0 %	All set-ups	TRUE	-2	uint_16
6-74	Terminal 45 Output Max Scale	100.0 %	All set-ups	TRUE	-2	uint_16
6-76	Terminal 45 Output Bus Control	0.0 %	All set-ups	TRUE	-2	uint_16
<b>6-9* Analog/Digital Output 42</b>						
6-90	Terminal 42 Mode	[0] 0-20 mA	All set-ups	TRUE	-	Uint8
6-91	Terminal 42 Analog Output	[0] No operation	All set-ups	TRUE	-	Uint8
6-92	Terminal 42 Digital Output	[0] No operation	All set-ups	TRUE	-	Uint8
6-93	Terminal 42 Output Min Scale	0.0 %	All set-ups	TRUE	-2	uint_16
6-94	Terminal 42 Output Max Scale	100.0 %	All set-ups	TRUE	-2	uint_16
6-96	Terminal 42 Output Bus Control	0.0 %	All set-ups	TRUE	-2	uint_16

## 5.1.9 8-\*\* Comm. and Options

5

Par. No. #	Parameter description	Default value	2-set-up	Change during operation	Conversion index	Type
<b>8-0* General Settings</b>						
8-01	Control Site	[0] Digital and ctrl.word	All set-ups	TRUE	-	Uint8
8-02	Control Source	[1] FC Port	All set-ups	TRUE	-	Uint8
8-03	Control Timeout Time	1.0 s	1 set-up	TRUE	-1	uint_16
8-04	Control Timeout Function	[0] Off	1 set-up	TRUE	-	Uint8
<b>8-3* FC Port Settings</b>						
8-30	Protocol	[0] FC	1 set-up	TRUE	-	Uint8
8-31	Address	1.0 N/A	1 set-up	TRUE	0	uint_8
8-32	Baud Rate	ExpressionLimit	1 set-up	TRUE	-	Uint8
8-33	Parity / Stop Bits	ExpressionLimit	1 set-up	TRUE	-	Uint8
8-35	Minimum Response Delay	0.01 s	1 set-up	TRUE	-3	uint_16
8-36	Maximum Response Delay	ExpressionLimit	1 set-up	TRUE	-3	uint_16
8-37	Maximum Inter-char delay	0.025 s	1 set-up	TRUE	-3	uint_16
<b>8-5* Digital/Bus</b>						
8-50	Coasting Select	[3] Logic OR	All set-ups	TRUE	-	Uint8
8-51	Quick Stop Select	[3] Logic OR	All set-ups	TRUE	-	Uint8
8-52	DC Brake Select	[3] Logic OR	All set-ups	TRUE	-	Uint8
8-53	Start Select	[3] Logic OR	All set-ups	TRUE	-	Uint8
8-54	Reversing Select	[0] Digital input	All set-ups	TRUE	-	Uint8
8-55	Set-up Select	[3] Logic OR	All set-ups	TRUE	-	Uint8
8-56	Preset Reference Select	[3] Logic OR	All set-ups	TRUE	-	Uint8
<b>8-7* BACnet</b>						
8-70	BACnet Device Instance	1 N/A	1 set-up	TRUE	0	Uint32
8-72	MS/TP Max Masters	127.0 N/A	1 set-up	TRUE	0	uint_8
8-73	MS/TP Max Info Frames	1.0 N/A	1 set-up	TRUE	0	uint_16
8-74	"I am" Service	[0] Send at power-up	1 set-up	TRUE	-	Uint8
8-75	Initialisation Password	[admin]	1 set-up	TRUE	0	VisStr[2 1]
<b>8-8* FC Port Diagnostics</b>						
8-80	Bus Message Count	0.0 N/A	1 set-up	TRUE	0	uint_32
8-81	Bus Error Count	0.0 N/A	1 set-up	TRUE	0	uint_32
8-82	Slave Messages Rcvd	0.0 N/A	1 set-up	TRUE	0	uint_32
8-83	Slave Error Count	0.0 N/A	1 set-up	TRUE	0	uint_32
8-84	Slave Messages Sent	0.0 N/A	1 set-up	TRUE	0	uint_32
8-85	Slave Timeout Errors	0.0 N/A	1 set-up	TRUE	0	uint_32
8-88	Reset FC port Diagnostics	[0] Do not reset	1 set-up	TRUE	-	Uint8
<b>8-9* Bus Feedback</b>						
8-94	Bus Feedback 1	0.0 N/A	All set-ups	TRUE	0	Int16

## 5.1.10 13-\*\* Smart Logic

Par. No. #	Parameter description	Default value	2-set-up	Change during operation	Conversion index	Type
<b>13-0* SLC Settings</b>						
13-00	SL Controller Mode	[0] Off	1 set-up	TRUE	-	Uint8
13-01	Start Event	[39] Start command	1 set-up	TRUE	-	Uint8
13-02	Stop Event	[40] Drive stopped	1 set-up	TRUE	-	Uint8
13-03	Reset SLC	[0] Do not reset SLC	1 set-up	TRUE	-	Uint8
<b>13-1* Comparators</b>						
13-10	Comparator Operand	[0] Disabled	1 set-up	TRUE	-	Uint8
13-11	Comparator Operator	[1] Approx.Equal (~)	1 set-up	TRUE	-	Uint8
13-12	Comparator Value	0.0 N/A	1 set-up	TRUE	-1	Int32
<b>13-2* Timers</b>						
13-20	SL Controller Timer	0.0 s	1 set-up	TRUE	-2	uint_32
<b>13-4* Logic Rules</b>						
13-40	Logic Rule Boolean 1	[0] False	1 set-up	TRUE	-	Uint8
13-41	Logic Rule Operator 1	[0] Disabled	1 set-up	TRUE	-	Uint8
13-42	Logic Rule Boolean 2	[0] False	1 set-up	TRUE	-	Uint8
13-43	Logic Rule Operator 2	[0] Disabled	1 set-up	TRUE	-	Uint8
13-44	Logic Rule Boolean 3	[0] False	1 set-up	TRUE	-	Uint8
<b>13-5* States</b>						
13-51	SL Controller Event	[0] False	1 set-up	TRUE	-	Uint8
13-52	SL Controller Action	[0] Disabled	1 set-up	TRUE	-	Uint8

## 5.1.11 14-\*\* Special Functions

Par. No. #	Parameter description	Default value	2-set-up	Change during operation	Conversion index	Type
<b>14-0* Inverter Switching</b>						
14-01	Switching Frequency	ExpressionLimit	All set-ups	TRUE	-	Uint8
14-03	Overmodulation	[1] On	All set-ups	FALSE	-	Uint8
14-08	Damping Gain Factor	96.0 %	All set-ups	TRUE	0	uint_8
<b>14-1* Mains On/Off</b>						
14-12	Function at Mains Imbalance	[0] Trip	1 set-up	TRUE	-	Uint8
<b>14-2* Reset Functions</b>						
14-20	Reset Mode	[0] Manual reset	All set-ups	TRUE	-	Uint8
14-21	Automatic Restart Time	10.0 s	All set-ups	TRUE	0	uint_16
14-22	Operation Mode	[0] Normal operation	All set-ups	TRUE	-	Uint8
14-27	Action At Inverter Fault	[1] Warning	All set-ups	TRUE	-	Uint8
<b>14-4* Energy Optimising</b>						
14-40	VT Level	90 %	All set-ups	FALSE	0	uint_8
14-41	AEO Minimum Magnetisation	66 %	All set-ups	FALSE	0	uint_8
<b>14-5* Environment</b>						
14-50	RFI Filter	[1] On	1 set-up	FALSE	-	Uint8
14-51	DC-Link Voltage Compensation	[1] On	All set-ups	FALSE	-	Uint8
14-52	Fan Control	[0] Auto	1 set-up	TRUE	-	Uint8
14-53	Fan Monitor	[1] Warning	1 set-up	TRUE	-	Uint8
14-55	Output Filter	[0] No Filter	1 set-up	FALSE	-	Uint8
<b>14-6* Auto Derate</b>						
14-63	Min Switch Frequency	1.0 kHz	1 set-up	FALSE	0	uint_16



## 5.1.12 15-\*\* Drive Information

Par. No. #	Parameter description	Default value	2-set-up	Change during operation	Conversion index	Type
<b>15-0* Operating Data</b>						
15-00	Operating Hours	0 h	All set-ups	TRUE	74	uint_32
15-01	Running Hours	0 h	All set-ups	TRUE	74	uint_32
15-02	kWh Counter	0 kWh	All set-ups	TRUE	75	uint_32
15-03	Power Up's	0 N/A	All set-ups	TRUE	0	uint_32
15-04	Over Temp's	0 N/A	All set-ups	TRUE	0	uint_16
15-05	Over Volt's	0 N/A	All set-ups	TRUE	0	uint_16
15-06	Reset kWh Counter	[0] Do not reset	All set-ups	TRUE	-	Uint8
15-07	Reset Running Hours Counter	[0] Do not reset	All set-ups	TRUE	-	Uint8
<b>15-3* Alarm Log</b>						
15-30	Alarm Log: Error Code	0 N/A	All set-ups	TRUE	0	uint_8
<b>15-4* Drive Identification</b>						
15-40	FC Type	0 N/A	1 set-up	FALSE	0	VisStr[6]
15-41	Power Section	0 N/A	1 set-up	FALSE	0	VisStr[20]
15-42	Voltage	0 N/A	1 set-up	FALSE	0	VisStr[20]
15-43	Software Version	0 N/A	1 set-up	FALSE	0	VisStr[20]
15-44	Ordered TypeCode	0 N/A	1 set-up	FALSE	0	VisStr[40]
15-46	Drive Ordering No	0 N/A	1 set-up	FALSE	0	VisStr[8]
15-47	Power Card Ordering No	0 N/A	1 set-up	FALSE	0	VisStr[8]
15-48	LCP Id No	0 N/A	1 set-up	FALSE	0	VisStr[21]
15-49	SW ID Control Card	0 N/A	1 set-up	FALSE	0	VisStr[21]
15-50	SW ID Power Card	0 N/A	1 set-up	FALSE	0	VisStr[21]
15-51	Drive Serial Number	0 N/A	1 set-up	FALSE	0	VisStr[10]
15-53	Power Card Serial Number	0 N/A	1 set-up	FALSE	0	VisStr[20]

## 5.1.13 16-\*\* Data Readouts

Par. No. #	Parameter description	Default value	2-set-up	Change during operation	Conversion index	Type
<b>16-0* General Status</b>						
16-00	Control Word	0 N/A	1 set-up	TRUE	0	uint_16
16-01	Reference [Unit]	0.0 ReferenceFeedbackUnit	1 set-up	TRUE	-3	Int32
16-02	Reference [%]	0.0 %	1 set-up	TRUE	-1	Int16
16-03	Status Word	0 N/A	1 set-up	TRUE	0	uint_16
16-05	Main Actual Value [%]	0.0 %	1 set-up	TRUE	-2	Int16
16-09	Custom Readout	0.0 CustomReadoutUnit	1 set-up	TRUE	-2	Int32
<b>16-1* Motor Status</b>						
16-10	Power [kW]	0.00 kW	1 set-up	TRUE	-3	UInt32
16-11	Power [hp]	0.00 hp	1 set-up	TRUE	-3	UInt32
16-12	Motor Voltage	0.0 V	1 set-up	TRUE	-1	UInt32
16-13	Frequency	0.0 Hz	1 set-up	TRUE	-1	UInt32
16-14	Motor Current	0.00 A	1 set-up	TRUE	-2	UInt16
16-15	Frequency [%]	0.0 %	1 set-up	TRUE	-1	uint_16
16-18	Motor Thermal	0.0 %	1 set-up	TRUE	0	uint_8
<b>16-3* Drive Status</b>						
16-30	DC Link Voltage	0 V	1 set-up	TRUE	0	UInt32
16-34	Heatsink Temp.	0 °C	1 set-up	TRUE	100	uint_8
16-35	Inverter Thermal	0.0 %	1 set-up	TRUE	0	uint_8
16-36	Inv. Nom. Current	0.0 A	1 set-up	TRUE	-2	uint_16
16-37	Inv. Max. Current	0.0 A	1 set-up	TRUE	-2	uint_16
16-38	SL Controller State	0 N/A	1 set-up	TRUE	0	uint_8
<b>16-5* Ref. &amp; Feedb.</b>						
16-50	External Reference	0.0 %	1 set-up	TRUE	-1	Int16
16-52	Feedback[Unit]	0.0 ProcessCtrlUnit	1 set-up	TRUE	-3	Int32
<b>16-6* Inputs &amp; Outputs</b>						
16-60	Digital input	0 N/A	1 set-up	TRUE	0	UInt16
16-61	Terminal 53 Setting	[0] Current mode	1 set-up	TRUE	-	UInt8
16-62	Analog Input AI53	1.000 N/A	1 set-up	TRUE	-2	UInt16
16-63	Terminal 54 Setting	[0] Current mode	1 set-up	TRUE	-	UInt8
16-64	Analog Input AI54	1.000 N/A	1 set-up	TRUE	-2	UInt16
16-65	Analog Output AO42 [mA]	0.000 mA	1 set-up	TRUE	-2	UInt16
16-66	Digital Output	0 N/A	1 set-up	TRUE	0	VisStr[4 ]
16-71	Relay Output [bin]	0 N/A	1 set-up	TRUE	0	UInt16
16-72	Counter A	0.0 N/A	1 set-up	TRUE	0	Int16
16-73	Counter B	0.0 N/A	1 set-up	TRUE	0	Int16
16-79	Analog Output AO45	0.000 mA	1 set-up	TRUE	-2	UInt16
<b>16-8* Fieldbus &amp; FC Port</b>						
16-86	FC Port REF 1	0 N/A	1 set-up	TRUE	0	Int16
<b>16-9* Diagnosis Readouts</b>						
16-90	Alarm Word	0.0 N/A	1 set-up	TRUE	0	uint_32
16-91	Alarm Word 2	0.0 N/A	1 set-up	TRUE	0	uint_32
16-92	Warning Word	0.0 N/A	1 set-up	TRUE	0	uint_32
16-93	Warning Word 2	0.0 N/A	1 set-up	TRUE	0	uint_32
16-94	Ext. Status Word	0.0 N/A	1 set-up	TRUE	0	uint_32
16-95	Ext. Status Word 2	0.0 N/A	1 set-up	TRUE	0	uint_32

## 5.1.14 18-\*\* Info &amp; Readouts

Par. No. #	Parameter description	Default value	2-set-up	Change during operation	Conversion index	Type
<b>18-1* Fire Mode Log</b>						
18-10	FireMode Log:Event	0 N/A	1 set-up	TRUE	0	uint_8

## 5.1.15 20-\*\* Drive Closed Loop

Par. No. #	Parameter description	Default value	2-set-up	Change during operation	Conversion index	Type
<b>20-0* Feedback</b>						
20-00	Feedback 1 Source	[0] No function	All set-ups	TRUE	-	Uint8
20-01	Feedback 1 Conversion	[0] Linear	All set-ups	TRUE	-	Uint8
<b>20-8* PI Basic Settings</b>						
20-81	PI Normal/ Inverse Control	[0] Normal	All set-ups	TRUE	-	Uint8
20-83	PI Start Speed [Hz]	0.0 Hz	All set-ups	TRUE	-1	uint_16
20-84	On Reference Bandwidth	5.0 %	All set-ups	TRUE	0	uint_8
<b>20-9* PI Controller</b>						
20-91	PI Anti Windup	[1] On	All set-ups	TRUE	-	Uint8
20-93	PI Proportional Gain	0.01 N/A	All set-ups	TRUE	-2	uint_16
20-94	PI Integral Time	9999.0 s	All set-ups	TRUE	-2	uint_32
20-97	PI Feed Forward Factor	0.0 %	All set-ups	TRUE	0	uint_16

## 5.1.16 22-\*\* Appl. Functions

Par. No. #	Parameter description	Default value	2-set-up	Change during operation	Conversion index	Type
<b>22-4* Sleep Mode</b>						
22-40	Minimum Run Time	10.0 s	All set-ups	TRUE	0	uint_16
22-41	Minimum Sleep Time	10.0 s	All set-ups	TRUE	0	uint_16
22-43	Wake-Up Speed [Hz]	10.0 Hz	All set-ups	TRUE	-1	uint_16
22-44	Wake-Up Ref./FB Diff	10.0 %	All set-ups	TRUE	0	uint_8
22-45	Setpoint Boost	0.0 %	All set-ups	TRUE	0	Int8
22-46	Maximum Boost Time	60 s	All set-ups	TRUE	0	uint_16
22-47	Sleep Speed [Hz]	0.0 s	All set-ups	TRUE	-1	uint_16
<b>22-6* Broken Belt Detection</b>						
22-60	Broken Belt Function	[0] Off	All set-ups	TRUE	-	Uint8
22-61	Broken Belt Torque	10 %	All set-ups	TRUE	0	uint_8
22-62	Broken Belt Delay	10 s	All set-ups	TRUE	0	uint_16

## 5.1.17 24-\*\* Appl. Functions 2

Par. No. #	Parameter description	Default value	2-set-up	Change during operation	Conversion index	Type
<b>24-0* Fire Mode</b>						
24-00	FM Function	[0] Disabled	1 set-up	TRUE	-	Uint8
24-05	FM Preset Reference	0 Hz	All set-ups	TRUE	-2	Int16
24-09	FM Alarm Handling	[1] Trip, Crit.Alarms	1 set-up	FALSE	-	Uint8
<b>24-1* Drive Bypass</b>						
24-10	Drive Bypass Function	[0] Disabled	1 set-up	TRUE	-	Uint8
24-11	Drive Bypass Delay Time	0.0 s	1 set-up	TRUE	0	uint_16

**Index**

**A**

**Abbreviations**..... 6

**Action At Inverter Fault**..... 59

**Active Set-up**..... 21

**Address**..... 46

**AEO**..... 59

**Alarm**

- Log..... 61
- Log: Error Code..... 61
- Log: Value..... 61
- Word..... 66
- Word 2..... 66
- Words..... 76

**Alarm/Warning Code List**..... 75

**Alarms And Warnings**..... 74

**Alpha Numeric Display**..... 12

**Analog**

- Input AI53..... 65
- Input AI54..... 65
- Inputs..... 8
- Output AO42 [mA]..... 65

**Auto**

- DC Braking IT..... 21
- Energy Optimization VT..... 24

[

**[Auto On] Key On LCP**..... 23

**A**

**Automatic**

- Motor Adaption (AMA)..... 25
- Restart Time..... 59

**B**

**BACnet**

- BACnet..... 48
- Device Instance..... 48

**Baud Rate**..... 46

**Break-away Torque**..... 8

**Broken**

- Belt Delay..... 70
- Belt Detection..... 70
- Belt Function..... 70
- Belt Torque..... 70

**Bus**

- Controlled..... 40
- Feedback..... 49

**C**

**Changes Made**..... 18

**Closed**

- Loop..... 24
- Loop Set-up Wizard..... 16, 17

**Coast Inverse**..... 35

**Coasting**

- Coasting..... 7
- Select..... 47

**Comparator**

- Operand..... 52
- Operator..... 52
- Value..... 53

**Comparators**..... 2

**Control**

- Site..... 46
- Timeout Time..... 46
- Word..... 63

**Copyright, Limitation Of Liability And Revision Rights**..... 5

**Counter**

- A..... 65
- B..... 65

**Current Limit**..... 33

**Custom**

- Readout..... 63
- Readout Unit..... 22

**D**

**Data Readouts**..... 63

**DC**

- Brake Current..... 29
- Brake Cut In Speed..... 29
- Braking Time..... 29
- Hold/Motor Preheat Current..... 29
- Link Compensation..... 59

**Default Settings**..... 80

**Definitions**..... 7

**Digital**

- Input..... 65
- Input 29 Mode..... 35
- Input Function..... 35
- Input Mode..... 35
- Inputs..... 35
- Output..... 65

**Drive**

- Bypass..... 72
- Identification..... 61

**E**

**Energy Optimising**..... 59

**Environment**..... 59

**Extended**

- Status Word..... 66
- Status Word 2..... 66
- Status Words..... 77

<b>External</b>		
Interlock.....	35	
Reference.....	64	
<b>F</b>		
<b>Fan</b>		
Control.....	59	
Monitor.....	59	
<b>Fault Messages.....</b>	<b>77</b>	
<b>FC</b>		
Closed Loop.....	67	
Port Diagnostics.....	2	
Port Settings.....	2	
<b>Feedback</b>		
Feedback.....	67	
1 Conversion.....	67	
1 Source.....	67	
<b>Fieldbus &amp; FC Port.....</b>	<b>66</b>	
<b>Fire</b>		
Mode.....	36, 71	
Mode Log.....	67	
<b>Flying Start.....</b>	<b>27</b>	
<b>FM Function.....</b>	<b>71</b>	
<b>Freeze Output.....</b>	<b>7, 36</b>	
<b>Frequency</b>		
Frequency.....	64	
[%].....	64	
<b>Function</b>		
At Mains Imbalance.....	58	
At Stop.....	28	
Relay.....	38	
<b>G</b>		
<b>Grid Type.....</b>	<b>20</b>	
<b>[</b>		
<b>[Hand On] Key On LCP.....</b>	<b>23</b>	
<b>H</b>		
<b>Hand Start.....</b>	<b>36</b>	
<b>Heatsink Temp.....</b>	<b>64</b>	
<b>How To Programme.....</b>	<b>12</b>	
<b>I</b>		
<b>Initialisation.....</b>	<b>19, 59</b>	
<b>Introduction.....</b>	<b>5</b>	
<b>Inverter</b>		
Maximum Current.....	64	
Nominal Current.....	64	
Switching.....	2	
Thermal.....	64	
<b>J</b>		
<b>Jog</b>		
Jog.....	7, 35	
Ramp Time.....	32	
Speed [Hz].....	30	
<b>K</b>		
<b>KWh Counter.....</b>	<b>61</b>	
<b>L</b>		
<b>Language.....</b>	<b>20</b>	
<b>Latched Start.....</b>	<b>35</b>	
<b>LCP</b>		
Copy.....	19, 23	
Custom Readout.....	22	
<b>Link Setups.....</b>	<b>21</b>	
<b>Literature.....</b>	<b>7</b>	
<b>Live Zero.....</b>	<b>41</b>	
<b>Load Compensations.....</b>	<b>24</b>	
<b>Local</b>		
Control Panel (LCP).....	12	
Reference.....	20	
<b>Logic</b>		
Rule Boolean 2.....	54	
Rule Boolean 3.....	55	
Rule Operator 1.....	54	
Rule Operator 2.....	55	
Rules.....	53	
<b>M</b>		
<b>Main</b>		
Actual Value.....	63	
Menu.....	18	
Reactance.....	25, 26	
<b>Mains</b>		
On/Off.....	58	
Supply.....	9	
<b>Max. Output Frequency.....</b>	<b>33</b>	
<b>Maximum</b>		
Boost Time.....	70	
Inter-char Delay.....	47	
Reference.....	30	
Response Delay.....	47	
<b>Menu Key.....</b>	<b>12</b>	
<b>Minimum</b>		
Reference.....	30	
Response Delay.....	47	
Sleep Time.....	69	
<b>Missing Motor Phase Function.....</b>	<b>33</b>	

<b>Motor</b>		<b>Power</b>	
Control Principle.....	24	In Hp.....	64
Current.....	25, 64	In KW.....	63
Frequency.....	25	Up's.....	61
Magnetisation At Zero Speed.....	26	<b>Preset</b>	
Poles.....	26	Ref Bit 0.....	35
Set-up.....	18	Ref Bit 1.....	35
Speed Direction.....	33	Ref Bit 2.....	35
Speed High Limit.....	33	Reference.....	30
Speed Low Limit.....	33	Relative Reference.....	30
Status.....	63	<b>Programming</b>	
Thermal.....	64	Set-up.....	21
Thermal Protection.....	28	With MCT-10 Setup Software.....	12
Voltage.....	25, 64	<b>Protection Mode</b> .....	10
		<b>Protocol</b> .....	46
<b>N</b>		<b>Q</b>	
<b>Navigation Keys And Indicator Lights (LEDs)</b> .....	12	<b>Quick</b>	
<b>Nominal Motor Speed</b> .....	25	Menu.....	13
<b>Not Changeable During Operation</b> .....	21	Stop Ramp Time.....	32
<b>NPN</b> .....	35		
		<b>R</b>	
[		<b>Ramp</b>	
[Off/Reset] Key On LCP.....	23	1 Ramp Down Time.....	31
		1 Ramp Up Time.....	31
<b>O</b>		2 Ramp Down Time.....	32
<b>On Reference Bandwidth</b> .....	67	2 Ramp Up Time.....	31
<b>Open Loop</b> .....	24	<b>Rated Motor Speed</b> .....	7
<b>Operating</b>		<b>RCD</b> .....	8
Data.....	61	<b>Reference</b>	
Hours.....	61	1 Source.....	30
Mode.....	20	2 Source.....	31
State At Power-up.....	20	3 Source.....	31
<b>Operation</b>		<b>Regional Settings</b> .....	20
Keys And Indicator Lights (LEDs).....	12	<b>Relay Output [bin]</b> .....	65
Mode.....	59	<b>Relays</b> .....	38
<b>Output Filter</b> .....	59	<b>Reset</b>	
<b>Over</b>		Control Word Timeout.....	46
Temp's.....	61	KWh Counter.....	61
Volt's.....	61	Mode.....	58
<b>Overmodulation</b> .....	58	Running Hours Counter.....	61
<b>Over-voltage Control</b> .....	29	SLC.....	52
		<b>Resonance Dampening</b> .....	27
<b>P</b>		<b>Reversing</b> .....	35
<b>Parameter Lists</b> .....	80	<b>RFI Filter</b> .....	59
<b>Parity And Stop Bits</b> .....	46	<b>Run Permissive</b> .....	36
<b>Password</b> .....	23	<b>Running Hours</b> .....	61
<b>PI</b>			
Anti Windup.....	68	<b>S</b>	
Basic Settings.....	67	<b>Safety Precautions</b> .....	9
Controller.....	68	<b>Semi-Auto Bypass Set-up</b> .....	34
Integral Time.....	68	<b>Serial Communication</b> .....	8, 39
Normal/ Inverse Control.....	67	<b>Setpoint Boost</b> .....	70
Proportional Gain.....	68		
<b>PNP</b> .....	35		

**Set-up Copy**..... 23

**SL**

- Controller Action..... 56
- Controller Mode..... 50
- Controller Timer..... 53

**SLC Settings**..... 2

**Sleep**

- Mode..... 69
- Speed [Hz]..... 70

**Slip Compensation**..... 27

**Smart**

- Logic..... 50
- Logic Controller Event..... 56

**Software Version**..... 62, 5

**Special Functions**..... 58

**Speed**

- Bypass..... 34
- Down..... 36
- Up..... 36

**Square Root**..... 67

**Start**

- Start..... 35
- Delay..... 27
- Event..... 50
- Function..... 27
- Reversing..... 35

**Start-up Wizard For Open Loop Applications**..... 13

**States**..... 56

**Stator**

- Leakage Reactance..... 25, 26
- Resistance..... 26

**Status**

- Status..... 13
- Word..... 63

**Stop Event**..... 51

**Switching Frequency**..... 58

**Symbols**..... 6

**Synchronous Motor Speed**..... 7

**T**

**Terminal**

- 18 Digital Input..... 37
- 19 Digital Input..... 37
- 27 Digital Input..... 37
- 29 Digital Input..... 38
- 42 Analog Output..... 44
- 42 Digital Output..... 44
- 42 Mode..... 44
- 42 Output Max Scale..... 45
- 42 Output Min Scale..... 44
- 45 Analog Output..... 42
- 45 Digital Output..... 43
- 45 Mode..... 42
- 45 Output Max Scale..... 43
- 45 Output Min Scale..... 43
- 53 Filter Time Constant..... 42
- 53 High Current..... 41
- 53 High Ref./Feedb. Value..... 41
- 53 High Voltage..... 41
- 53 Low Current..... 41
- 53 Low Ref./Feedb. Value..... 41
- 53 Low Voltage..... 41
- 53 Mode..... 42
- 53 Setting..... 65
- 54 Filter Time Constant..... 42
- 54 High Current..... 42
- 54 High Ref./Feedb. Value..... 42
- 54 High Voltage..... 42
- 54 Low Current..... 42
- 54 Low Ref./Feedb. Value..... 42
- 54 Low Voltage..... 42
- 54 Mode..... 42
- 54 Setting..... 65

**Thermal Load**..... 26

**Thermistor**

- Thermistor..... 9
- Source..... 28

**Timeout Function**..... 46

**Timers**..... 53

**Trip Reset**..... 58

**Troubleshooting**..... 74

**Two Finger Initialization**..... 19

**U**

**U/f Characteristic**..... 27

**V**

**WCplus**..... 9

**W**

**Warning**

- Current High..... 33
- Current Low..... 33
- Word..... 66
- Word 2..... 66
- Words..... 76



Wizard For Open Loop Applications..... 15



[www.danfoss.com/drives](http://www.danfoss.com/drives)

---

Danfoss can accept no responsibility for possible errors in catalogues, brochures and other printed material. Danfoss reserves the right to alter its products without notice. This also applies to products already on order provided that such alterations can be made without consequential changes being necessary in specifications already agreed. All trademarks in this material are property of the respective companies. Danfoss and the Danfoss logotype are trademarks of Danfoss A/S. All rights reserved.

---



