

Preface

Thanks for your purchase of CV3100 series and MINI series inverter manufactured by us. CV3100 series and MINI series inverter is of sensor-less vector control frequency inverter with high torque, high accuracy and wide range of speed regulation, designed with the brand-new idea. Based on improving stability, it is provided with many run and control functions such as motor parameters auto-tune, simple PLC control, practical PID adjustment, flexible input/output terminal control, parameter online amendment, pulse frequency setting, power-off and stopping parameter storage, wobbling control, RS485 communication, constant pressure water supply control and so on. This inverter provides equipment manufacturer and terminal user with integrated solution of high integration level; helps to reduce the system purchase and operation cost, and improves the reliability of system.

Before using CV3100 series inverter, please read this manual carefully, so as to install and operate inverter correctly and enable it produce the best performance.

It is to be noted that this manual is subject to change without notice, and please refer to new edition.

Reader range

This manual is suitable for following persons:

Installer of inverter, engineering technician (electric engineer, electric operating worker), designer

Please make sure that this manual is delivered to the end user.

Stipulation of this manual

Stipulation of symbol



Warning

Conditions that cause medium injury or light injury due to operation not accord to requirements



Danger

Conditions that cause death or serious injury due to operation not accord to requirements

— Contents —

Chapter 1 General

1.1 Confirmation of product-----	(1-1)
1.2 Safety attentions-----	(1-2)
1.3 Attentions of use-----	(1-4)
1.4 Rejection attentions -----	(1-6)

Chapter 2 Product specification and order notification

2.1 Inverter series model-----	(2-1)
2.2 Specifications -----	(2-3)
2.3 Outline of inverter-----	(2-5)
2.4 Outline size-----	(2-5)
2.5 Option-----	(2-10)

Chapter 3 Installation and wiring of inverter

3.1 Installation environment of inverter-----	(3-1)
3.2 Disassembling and installing of inverter panel-----	(3-2)
3.3 Attentions of inverter wiring-----	(3-2)
3.4 Wiring of main circuit terminal-----	(3-3)
3.5 Diagram of wiring for basic running-----	(3-9)
3.6 Control circuit configuration and wiring -----	(3-13)
3.7 Installation guide in line with EMC requirement-----	(3-19)

Chapter 4 Running and operating of inverter

4.1 Running of inverter -----	(4-1)
4.2 Operating and using of keyboard-----	(4-3)
4.3 Inverter electrification-----	(4-7)

Chapter 5 Function parameter table

5.1 Introduction of symbol -----	(5-1)
5.2 Function code table-----	(5-1)

Chapter 6 Specification of function parameter table

6.1 Basic parameter (P0.00—P0.23) -----	(6-1)
6.2 Motor and vector control parameter (P1.00—P1.15)-----	(6-12)
6.3 Auxiliary parameter(P2.00—P2.43)-----	(6-15)
6.4 User managing interface parameter(P3.00—P3.09)-----	(6-24)
6.5 Digital input/output parameter (P4.00—P4.16)-----	(6-27)
6.6 Analog input/output parameter(P5.00—P5.16)-----	(6-37)
6.7 Process PID control parameter(P6.00—P6.14)-----	(6-42)
6.8 Programmable running parameter (P7.00—P7.18)-----	(6-50)
6.9 Communication parameter(P8.00—P8.04)-----	(6-56)
6.10 Protection parameter(P9.00—P9.03)-----	(6-57)
6.11 Senior function parameter(PA.00—PA.12)-----	(6-59)

Chapter 7 Troubleshooting

7.1 Failure and countermeasure -----	(7-1)
7.2 Enquiry of fault record -----	(7-1)
7.3 Fault reset-----	(7-1)
7.4 Fault code and countermeasure -----	(7-2)

Chapter 8 Maintenance

8.1 Daily maintenance-----	(8-1)
8.2 Regular maintenance-----	(8-1)

Warranty of inverter-----	(A-1)
----------------------------------	--------------

Chapter 1 General

1.1 Confirmation of product

After unpacking, please check whether the inverter is scratched or damaged in course of carrying, and whether the rated value on the nameplate is in line with your order requirement.

If finding any problems, please contact supplier or us.

Model description

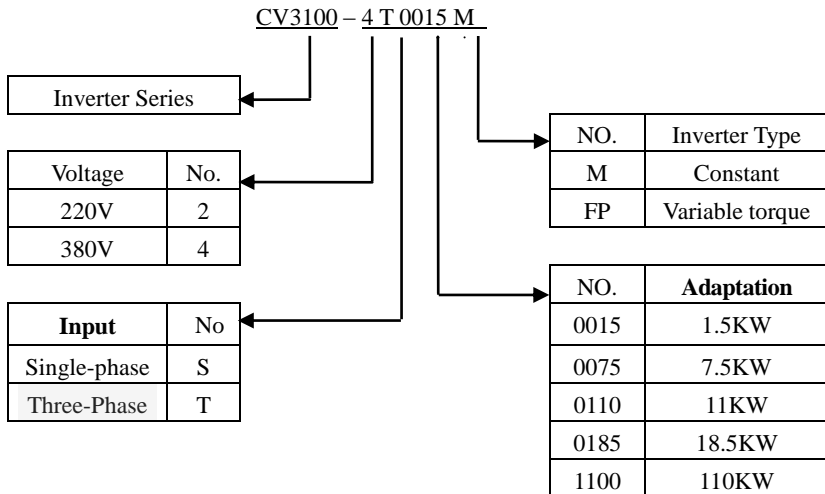

There is a nameplate with inverter model and rated value stuck on the lower part of right plate of inverter case, the information in it as follows:

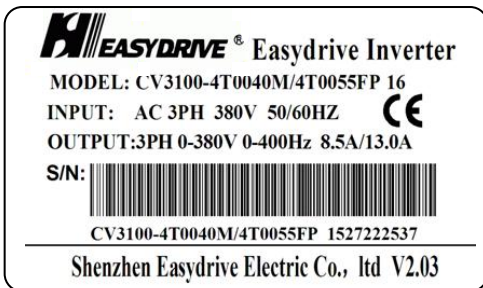

Diagram 1-2 Nameplate of inverter

1.2 Safety attentions

● Check after having received product



Warning

1. **The damaged inverter or the inverter lack of parts can't be installed.**
Otherwise, danger of injury would be caused.

● Installing



Warning

1. **When carrying, please hold the bottom of inverter.**
Only the panel is held, the inverter would fall off and such that you would be injured.
2. **Please install it on metallic plate not apt to be burned.**
Install it on the flammable material, there would be fire caused.
3. **If two or more inverters are installed in the same control cabinet, please mount a fan and keep the air inlet temperature at below 40°C.**
If too hot, there would be fire or other accidents caused.

● Connection



Danger

1. **Please make sure the input power supply has been cut off before connecting.**
Otherwise, danger of electric shock and fire would be caused.
2. **Lease invites electric engineering technicians to connect the wire.**
Otherwise, danger of electric shock and fire would be caused.
3. **The earthing terminal must be earthed reliably.**
(Class 380V: Suitable for earthing 3).
Danger of electric shock and fire would be caused.
4. **After electrifying the emergency stop terminal, please check the operation is available.**
Otherwise, danger of injury would be caused. (The connection

responsibility is borne by user)

- 5. Please never touch output terminal directly, connect inverter output terminal to enclosure, or give the short connection among output terminals.**

Otherwise, danger of electric shock and short circuit would be caused.



Warning

- 1. Please make sure that AC main circuit power supply is identical with the rated voltage of inverter.**

Otherwise, danger of injury and fire would be caused.

- 2. Never conduct withstand voltage test for inverter.**

Otherwise, damage of semiconducting elements would be caused.

- 3. Please connect the braking resistor or braking unit according to diagram.**

Otherwise, danger of fire would be caused

- 4. Please fasten the terminal by the screwdriver with specified torque.**

Otherwise, danger of fire would be caused.

- 5. Never connect the input power line to terminals U, V, W.**

Such that, the voltage is applied to output terminal, the inner of inverter would be damaged.

- 6. Never connect the phase-shift capacitor and LC/RC noise filter to output circuit.**

Otherwise, the inverter inner would be damaged.

- 7. Never connect electromagnetic switch and electromagnetic contactor to output circuit.**

When the inverter is running with the load, the surge current caused by operation of electromagnetic switch and electromagnetic contactor would cause over current protection circuit operation of inverter.

● **Maintaining and checking**



Danger

- 1. Never touch the connection terminal of inverter as the terminal has high voltage.**
Otherwise, danger of electric shock would be caused.
- 2. Before electrifying, please install the terminal enclosure reliably, and must cut off the power before disassembling the enclosure.**
Otherwise, danger of electric shock would be caused.
- 3. Laypeople are not allowed to maintain and check.**
Otherwise, danger of electric shock would be caused.



Warning

- 1. As CMOS integrated circuit is mounted on keyboard plate, control circuit plate, driving circuit plate, please pay special attention when using.**
Once the circuit plate is touched by finger, the integrated chip on circuit plate would be damaged for electrostatic induction.
- 2. In electrifying, never change the connecting wire or disassemble the connecting wire of terminal.**
In running, please never check the signal. Otherwise, the equipment would be damaged.

1.3 Attentions of use

Please pay attention following points when using CV3100 series inverter.

(1) Constant-torque and low-speed running

In case that the inverter with common motor runs at low speed for a long time, the life of motor would be affected for the poor heat radiation. So if it is needed low-speed & constant-torque long time running, professional inverter must be selected.

(2) Confirmation of motor insulation

When using CV3100 series inverter with motor, please check up the insulation of motor to protect equipment. In addition, if the motor is used in the harsh environment, it is very necessary to check up the insulation of motor regularly, so as to protect the

safety of system.

(3) Negative-torque load

The occasion that needs the load to be raised produces the negative torque usually, the inverter would generate over current or over voltage fault, and so it would trip, in case of this, a braking resistor shall be mounted.

(4) Mechanical resonance point of load device

In the certain output frequency range, the inverter is likely to meet the mechanical resonance point of load device, if that, the jumping frequency must be set to avoid this point.

(5) Capacitor or pressure sensitive element that improves power factor

If there is a capacitor or varistor for lightning protection that improves power factor mounted on the output side, they shall be removed, otherwise, the inverter would trip for fault or the parts would be damaged, because output voltage of inverter is the type of impulse wave. In addition, on the output side, it is suggested that air switch and contactor would not be installed either, shown as diagram 1-3. (If the switch unit has to be mounted on the side of output, the output current of inverter must be zero when the switch operates.)

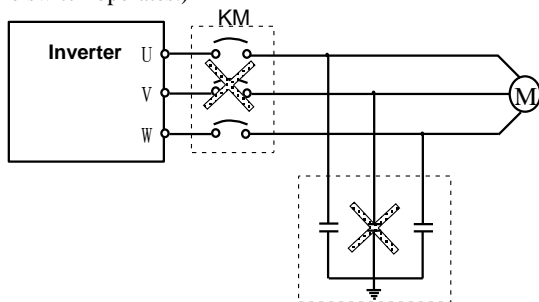

Diagram 1-3 Inverter output side never mounted with a capacitor

(6) Run at over 50Hz.

If the inverter has to run at over 50Hz, the applicable speed range of motor bearing and mechanical equipment must be guaranteed in addition to considering the vibration and noise of motor, and please inquire before inverter runs.

(7) Electronic heat protection value of motor

When a motor chosen is applicable, the inverter can provide the motor with heat protection. If the motor doesn't match with the rated capacity of inverter, the protection value must be adjusted or other protection measures must be taken, to guarantee the motor runs safely.

(8) Altitude and derating use

If the inverter runs in area of over 1000m altitude, it must be derated by reason that the heat radiation of inverter gets poor for rarefied air. Diagram 1-4 shows the relation between rated current of inverter and altitude. If the installation site is higher than 2000 m above sea level, the inverter will not be able to meet IEC61800-5-1 the requirements of low voltage protection .

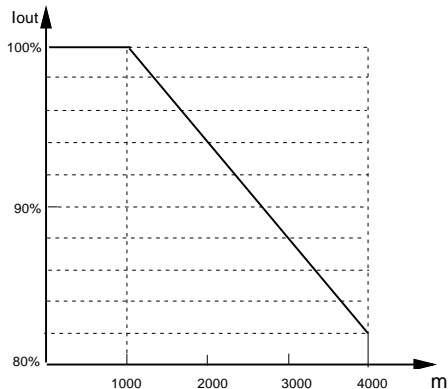

Diagram 1-4 Relation between rated output current of inverter and altitude

(9) Protection degree

Protection degree IP 20 of CV3100 inverter is got in the state of use or keyboard display.

1.4 Rejection attentions

Before scrapping the inverter, please pay attention following information:

When burning, the electrolytic capacitor of main circuit and electrolytic capacitor of printed board are likely to explode, and the plastic part will produce noxious gas. Therefore, the inverter shall be handled as the industrial rubbish.

Chapter 2 Product specification and order notification

2.1 Inverter series model

CV3100 series inverter has two voltage classes: 220V and 380V. The applicable motor power range is 0.75KW~630KW. CV3100 series inverter model is shown as table 2-1.

Table 2-1 Model of CV3100 series inverter

Voltage class	Model (M:Constant torque ; FP:Fan/pump)	Rated output current (A) M/FP
380V Three-phase	CV3100-4T0007M MINI-L-4T0007M	2.3
	CV3100-4T0015M MINI-L-4T0015M	3.7
	CV3100-4T0022M	5.5
	CV3100-4T0040M/4T0055FP	9.0/13.0
	CV3100-4T0055M/4T0075FP	13.0/17.0
	CV3100-4T0075M/4T0110FP	17.0/25.0
	CV3100-4T0110M/4T0150FP	25.0/33.0
	CV3100-4T0150M/4T0185FP	33.0/39.0
	CV3100-4T0185M/4T0220FP	39.0/45.0
	CV3100-4T0220M/4T0300FP	45.0/60.0
	CV3100-4T0300M/4T0370FP	60.0/75.0
	CV3100-4T0370M/4T0450FP	75.0/91.0
	CV3100-4T0450M/4T0550FP	91.0/112.0
	CV3100-4T0550M/4T0750FP	112.0/150.0
	CV3100-4T0750M/4T0930FP	150.0/176.0
	CV3100-4T0930M/4T1100FP	176.0/210.0

CV3100 series and MINI series high performance general purpose inverter instruction manual

	CV3100-4T1100M/4T1320FP	210.0/260.0
	CV3100-4T1320M/4T1600FP	260.0/310.0
	CV3100-4T1600M/4T1850FP	310.0/340.0
	CV3100-4T1850M/4T2000FP	340.0/385.0
	CV3100-4T2000M /4T2200FP	385.0/430.0
	CV3100-4T2200M/4T2500FP	430.0/475.0
	CV3100-4T2500M/4T2800FP	475.0/535.0
	CV3100-4T2800M/4T3150FP	535.0/600.0
	CV3100-4T3150M/4T3550FP	600.0/645.0
	CV3100-4T3550M/4T4000FP	645.0/750.0
	CV3100-4T4000M	750.0
	CV3100-4T5000FP	920.0
	CV3100-4T5000M	920.0
	CV3100-4T5600FP	1050.0
	CV3100-4T5600M	1050.0
	CV3100-4T6300FP	1150.0
	CV3100-4T6300M	1150.0
220V Single-phase	MINI-S-2S0007M MINI-L-2S0007M CV3100-2S0007M	5.0
	MINI-S-2S0015M MINI-L-2S0015M CV3100-2S0015M	7.5
	CV3100-2S0022M	10.0

Note: 220v voltage series other specifications can be conducted in accordance with user requirements of non-standard production.

2.2 Specifications

Item		Specifications
Input	Rated voltage and frequency	Single-phase 220V, three-phase 220V, three-phase 380V; 50Hz/60Hz
	Grid range	Voltage: -20% ~ +20%
Output	Rated voltage	0~220V /0~380V
	Frequency range	0Hz~400Hz
	Overload capability	M:150% for 1 min, 180% for 1s, 200% instant protection FP: 120% for 1 min, 150% for 1s, 180% instant protection
Main control function	Modulation mode	Space voltage vector PWM control ;
	Control mode	Sensorless vector control (SVC)
	Frequency accuracy	Digital setting: Max frequency $\times\pm 0.01\%$ Analog setting: Max frequency $\times\pm 0.2\%$
	Frequency resolution	Digital setting: 0.01Hz; Analog setting: Max frequency $\times 0.1\%$
	Starting Frequency	0.0Hz~10.00 Hz
	Torque rise	Auto torque rise, manual torque rise 1%~30.0%(valid for V/F)
	V/F curve	Three ways: Linear V/F curve, square V/F curve, user self-defining V/F curve
	Acceleration/ deceleration time	Optional time unit (Min/s), the longest: 3600s (settable in the range of 0.1~3600s).
	DC braking	Be optional during both starting and stopping, the operating frequency: 0~20Hz, operating time: settable within 0~30s
	Jogging	Jogging frequency range: 0.1Hz~50.00Hz, jogging acceleration and deceleration time: 0.1~3600s.
	Built-in PID	It is convenient for forming closed loop control system, applicable for course control like pressure and flow, etc.
	Multi-speed operating	Realize multi-speed running by built-in PLC or control terminal.
	Weaving wobble frequency	Can get wobble frequency of adjustable central frequency
	Auto voltage adjustment	When main voltage changes, the output voltage may be kept constant by adjusting PWM output (AVR function).
	Auto energy-saving running	According to load condition, V/F curve can be optimized automatically to get the aim of energy-saving running.
Auto current limiting	Limit in-service current automatically, so as to avoid tripping for fault caused by frequent over current.	

Item		Specifications
Sensorless vector control	Torsion characteristic	150% output of torque at 1Hz, rev accuracy: 0.1%
	Motor parameters automatic read	Reading the parameters from motor when completely stop in order to achieve optimal controlling effect.
Running function	Running command passage	Setting of operating manual; setting of control terminal; setting of serial port; switching by three ways.
	Frequency setting passage	Setting of keyboard analog potentiometer; setting of keyboard ▲, ▼ keys; setting of functional code digits; setting of serial port, setting of terminal UP/DOWN, setting of analog voltage, setting of analog current ; setting of impulse, setting of combination; switching at any time by kinds of setting ways.
	Switch input passage	Forward/reverse rotating command, 6-way programmable switching value input to set 30 functions.
	Analog input passage	2-way analog signal input, 0~20mA, 0~10V optional.
	Analog output passage	Analog signal output 0~10V 、 0~20mA to get output of physical quantity like frequency and output frequency
	Switch output passage	3-way programmable open collector output; 1-way relay output signal; can output different physical quantities.
Operating panel	LED display	Display setting frequency, output voltage, and output current and so on.
	Display external instrument	Display output frequency, output current, and output voltage and so on.
Protection function		Over current protection, over voltage protection, under voltage protection, over heat protection, over load protection.
Option		Braking unit, remote operating panel, remote cable, soleplate of keyboard.
Environment	Service location	Indoors, not suffer from sun, dust, corrosive gas, oil fog, and steam and so on.
	Altitude	Shorter than 1000m (derating at higher than 1000m)
	Environment temperature	-10℃~+40℃
	Humidity	Less than 90%RH, no condensation
	Vibration	Less than 5.9m/s ² (0.6M)
	Storage temperature	-20℃~+60℃
Structure	Protection class	IP20 (In service state or keyboard state.)
	Cooling way	Air-blast cooling
Installation Way	Wall-hanging,Cabinet	

2.3 Outline of inverter

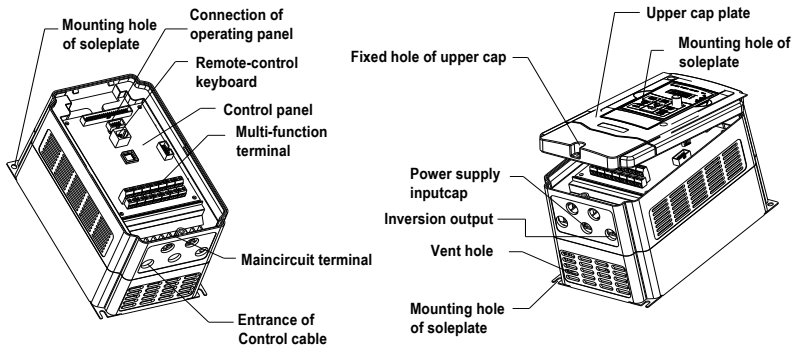

2.4 Outline size

MINI series

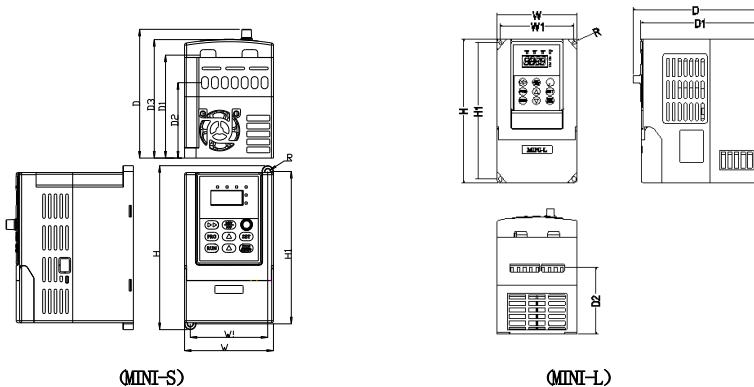

(unit : mm)

	W	W1	H	H1	H2	D	D1	D2	D3	R
MINI-S	85	74	155	144		122	72	98	112	2.5
MINI-L	98	88	175	165		152	142	80		3

CV3100 series

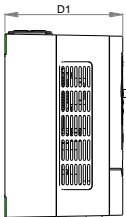
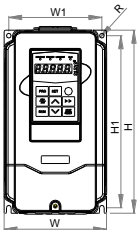
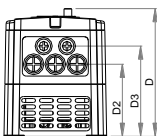

(a) : 0.75KW~4.0KW

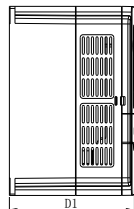
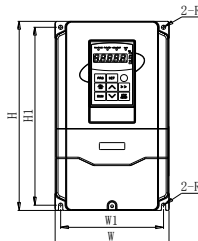
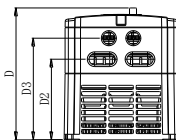

(b) : 5.5KW~7.5KW

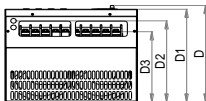
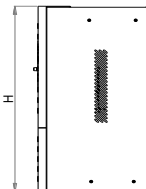
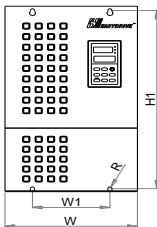
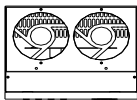

(c) : 11KW~75KW

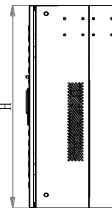
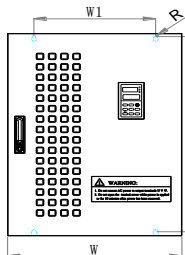
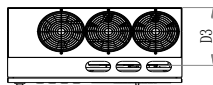

(d) : 93KW~280KW(wall mounting)

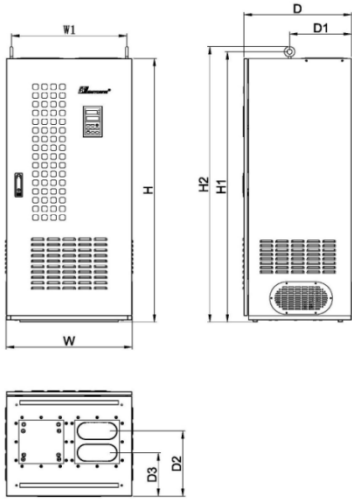

(e) : 160KW~200KW(cabinet)

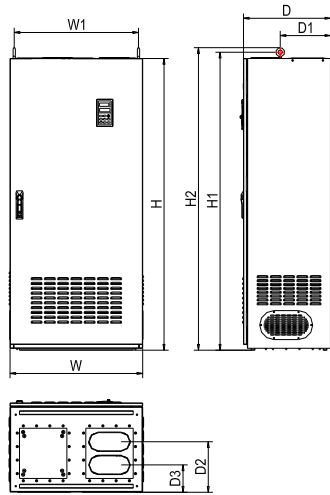

(f) : 220KW~280KW(cabinet)

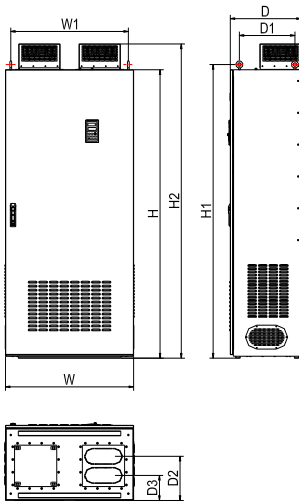

(g) : 315KW~400KW Size(cabinet)

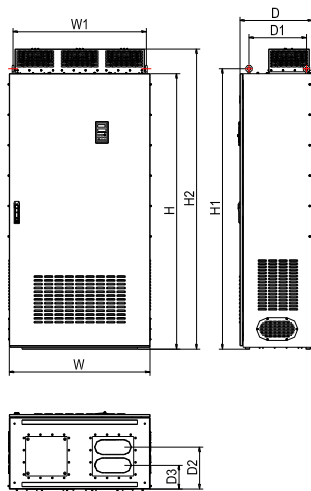

(h) : 500KW~630KW Size(cabinet)

Form 2-2 Exterior and Mounting Dimensions

Specification	W	H	D	W1	H1	D1	H2	D2	D3	Mounting Holes(R)	Refer
4T0007M/-	132	232	162	120	218	152		92	117	2.5	(a)
4T0015M/-											
4T0022M/-											
4T0040M/0055FP											
2S0007M/-											
2S0015M/-											
2S0022M/-											
4T0055M/0075FP	162.5	270	188.5	147	254	178.5		145	115	3	(b)
4T0075M/0110FP											
4T0110M/0150FP	249	352	229	200	334	218		181	156	4.5	(c)
4T0150M/0185FP											
4T0185M/0220FP											
4T0220M/0300FP	320	506	289	200	482	277		237	200	4.5	(c)
4T0300M/0370FP											
4T0370M/0450FP	342	561	292	200	529	281		246	213	5.5	(c)
4T0450M/0550FP											
4T0550M/0750FP	394	669	315	200	645	305		262	215	6	(c)
4T0750M/0930FP											
4T0930M/1100FP	573	776	298	400	748	287		219	221	5	(d)
4T1100M/1320FP											
4T1320M/1600FP	575	956	333	400	928	322		230	265	5	(d)
4T1600M/1850FP											
4T1850M/2000FP	625	1101	358	480	1073	348		234	272	5	(d)
4T2000M/2200FP											
4T2200M/2500FP	700	1100	446.5	500	1070	394		379	326	8	(d)
4T2500M/2800FP											
4T2800M/3150FP											

CV3100 series and MINI series high performance general purpose inverter instruction manual

Specification	W	H	D	W1	H1	D1	H2	D2	D3	Mounting Holes(R)	Refer
4T1600M/4T1850F	700	1510	407	656	1543	267	1566	262	142	cabinet	(e)
4T1850M/4T2000F											
4T2000M/4T2200F											
4T2200M/2500FP											
4T2500M/2800FP											
4T2800M/3150FP											
4T3150M/3550FP	850	1812	470.5	780	1845	368.5	1974	277.5	157.5	cabinet	(f)
4T3550M/4000FP											
4T4000M											
4T5000FP	950	1812	490.5	900	1845	388.5	1974	276	156	cabinet	(g)
4T5000M											
4T5600FP											
4T5600M											
4T6300FP											
4T6300M											

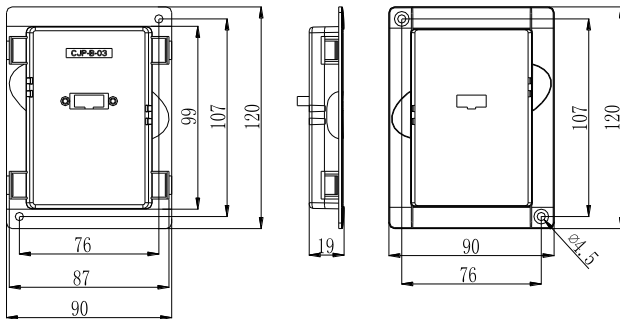

Diagram2-1 CV3100-LKD External lead splint Dimensions (Accessory Choosing)

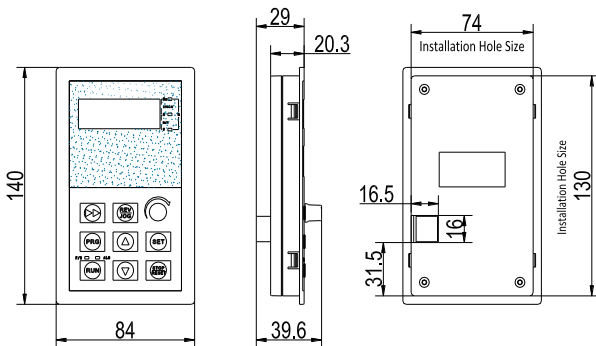

Diagram2-2 CV3100-RKD Remote Control Keyboard SPEC.

Note:Manufacturer reserves the right to modify the size without prior notice

2.5 Option: Following options please order separately.

2.5.1 Remote-control keyboard

Between CV3100 inverter and its remote-control keyboard are provided with RS485 communication way and connected by one 8-core network cable, the connection of port is provided with RJ45 network interface connection, it is very convenient to install. The max electric distance can reach as high as 500m. The remote-control keyboard has following functions:

- (1) Can control the running, stopping, jogging, fault resetting, change of setting frequency, change of function parameter and running direction of slave.
- (2) Can monitor operating frequency, setting frequency, output voltage, output current and so on.

2.5.2 Communication cable

Communication cable of remote-control keyboard

Model: CV3100-LAN0020 (2.0m)

Among the specifications, 1m, 2m, 5m, 10m and 20m are standard configuration of our inverter, if over 20m cables are is needed, please contact us. Be used for connection between remote operating keyboard and master of inverter.

2.5.3 Braking resistor

As CV3100 series inverter braking unit is option, if need, please indicate clearly when ordering. Energy-consumption braking resistor is provided as shown in table 2-4, and the installation of braking resistor wire is provided as shown in 2-3

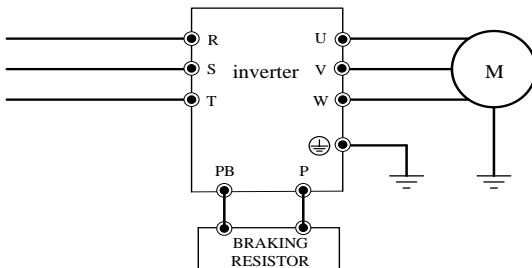

Diagram 2-3 Connection between inverter and braking unit (Below 380V 18.5 KW)

Table 2-4 Selectable table of braking resistor

Model No.	Applicable motor Power (KW)	Resistor Resistance (Ω)	Resistor Power (W)
CV3100-4T0007M	0.75KW	300 Ω	100W
CV3100-4T0015M	1.5KW	300 Ω	200W
CV3100-4T0022M	2.2KW	200 Ω	200W
CV3100-4T0040M	4.0KW	150 Ω	400W
CV3100-4T0055M	5.5KW	100 Ω	500W
CV3100-4T0075M	7.5KW	75 Ω	800W
CV3100-4T0110M	11KW	60 Ω	1000W
CV3100-4T0150M	15KW	45 Ω	1500W
CV3100-4T0185M	18.5KW	40 Ω	2000W

NOTE:

1. The standard product has built-in braking unit without braking resistor, if need braking resistor, user shall order from us separately and indicate clearly when ordering.
2. The device of 18.5KW and above need to be connected with braking resistor and unit outside. (If demands for them please inquire manufacturer).
3. Wiring of braking resistor should be less than 5m;The braking resistor would have temperature rise due to feedback energy consumption during dynamic braking, please ensure the safety protection and good ventilation.

Chapter 3 Installation and Wiring

3.1 Installation environment of inverter

3.1.1 Installation environment condition

- (1) The inverter shall be installed indoors of perfect ventilation, and the environment temperature shall be in the range of $-10\text{ }^{\circ}\text{C}\sim 40\text{ }^{\circ}\text{C}$, in case that the temperature exceeds $40\text{ }^{\circ}\text{C}$, the external air-blast cooling or derating shall be used.
- (2) Avoid being installed in the location where suffers from the sun, dust, floatation fiber and metallic powder.
- (3) Never to be installed in the location where corrosive and explosive gas has.
- (4) The humidity shall be lower than 95%RH, no condensation.
- (5) The inverter shall be installed in the location where the plane fixed vibration is less than $5.9\text{m/s}^2(0.6\text{g})$.
- (6) The inverter had better be kept far away from the electromagnetic interference device.

3.1.2 Installation direction and space

- (1) Shall be installed vertically usually.
- (2) The installation space and min distance are shown as diagram 3-1.
- (3) As is shown in diagram 3-2, there shall be a baffle mounted among them, when several inverters are installed vertically.

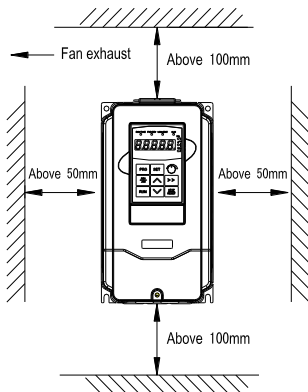

Diagram 3-1 Installation space

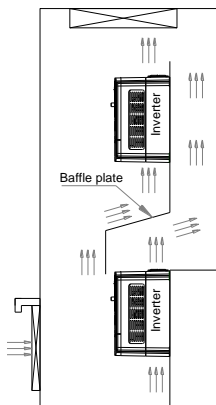

Diagram 3-2 Installation of multi inverters

3.2 Disassembling and installing of inverter panel

Disassemble: Remove two screws on the side of connection terminal with the cross screwdriver, i.e., the enclosure can be disassembled.

Install: Align the mounting screw, and then mount the screw.

3.3 Attentions of wiring



Warning

- (1) Before connecting, make sure the power supply has been cut off for more than 10min, otherwise, there would be electric shock danger.
- (2) Never to connect the power line to output terminals U,V,W of inverter.
- (3) Because there is leakage current in the inverter, the inverter and motor must be grounded safely, the grounding wire shall be copper conductor of more than 3.5 mm² and the grounding resistance shall be less than 10Ω.
- (4) User shall not conduct the withstand voltage test for the inverter as it has passed this test before leaving factory.
- (5) Between inverter and motor shall not be installed with the electromagnetic contactor and absorbing capacitor or other resistance--capacitance absorbing implements as diagram 3-3.
- (6) To take the convenience for over current protection of input side and power failure maintenance, the inverter shall be connected to power supply through intermediate breaker.
- (7) The connecting wire (DI1~DI6, DO1, DO2)of input and output circuit of relay shall be the stranded wire or shielded wire of over 0.75mm² one end of shielded layer shall be hung in the air, and the other is connected with the earthing terminal E of inverter, the connecting wire shall be less than 50m.



Danger

- (1) Make sure the power supply of inverter has been cut off thoroughly, all LED lamps of keyboard has went out, and wait for more than 10min, till now, can perform the wiring operation.
- (2) Make sure that DC voltage between main circuit terminals P+ and P- of inverter steps down to DC36V below, till now, start to perform the wiring operation.

- (3) Only the qualified professional who has been trained and authorized can perform the wiring operation.
- (4) Please pay attention that before energizing, check whether the voltage class of inverter is identical with the supply voltage, otherwise, it would result in person casualty and damage of device.

3.4 Wiring of main circuit terminal

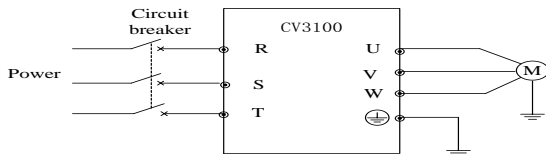

Diagram 3-3 Simple wiring of main circuit

3.4.1 Connection of inverter and option

- (1) Between power grid and inverter, breaking equipment like isolating switch shall be installed for human safety and compulsive power cutting during maintaining the device.
- (2) The supply circuit of inverter must be mounted with the fuse or circuit breaker with over current protection, to avoid the spread of fault.
- (3) When the power supply quality of power grid is not quite high, an AC input reactor shall be mounted additionally. The AC reactor also can improve the power factor of input side.
- (4) The contactor is only for control of power supply.

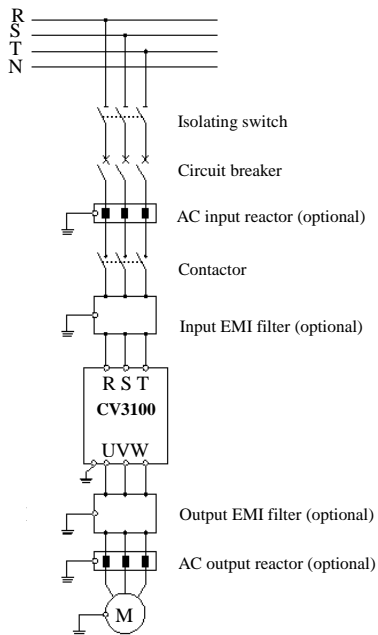

Diagram 3-4 Connection of inverter and option

- (5) EMI filter on the input side: The EMI filter can be used to prevent high-frequency conductivity interference and radio-frequency interference from the inverter power line.
- (6) EMI filter on the output side: The EMI filter can be used to prevent radio-frequency interference noise from output side of inverter and leakage current from conductor
- (7) AC output reactor When the wire connecting inverter to motor is more than 50m, AC output reactor had better be mounted to reduce the leakage current and prolong the service life of motor. When installing, please consider the voltage drop problem of AC output reactor; or the input/output voltage of inverter is stepped up or the motor is derated to protect the motor.
- (8) Safe grounding wire The inverter and motor must be earthed separately for safety as there is leakage current in the inverter; the grounding resistance shall be less than 10Ω . The grounding wire shall be as short as possible, and its diameter shall be in line with the standard given in table 3-1. Only two kinds of conductors are provided with the same metal, the value in the table can be correct, if not, the sectional area of protective conductor is determined with the equivalent conductive factor method and referred to table 3-1.

Table 3-1 Sectional area of protective conductor

Corresponding conductor sectional area (mm²)	Min sectional area of corresponding grounding conductor (mm²)
$S \leq 16$	S
$16 < S \leq 35$	16
$35 < S$	S/2

3.4.2 Wiring of main circuit terminal

(1)、Input/output terminal of main circuit shown as table 3-2

Applicable machine	Terminal of main circuit	Terminal name	Function description
CV3100-4T0007M- CV3100-4T0075M		R、S、T	Three-phaseAC 380V input
		U、V、W	Three-phaseAC output
		P+、PB	Braking resistor terminal
			DC bus“-”terminal
			Grounding terminal
CV3100-4T0110M- CV3100-4T0185M		R、S、T	Three-phaseAC 380V input
		U、V、W	Three-phaseAC output
		P+、PB	Braking resistor terminal
			DC bus“-”terminal
			Grounding terminal
CV3100-4T0220M- CV3100-4T0750M		R、S、T	Three-phaseAC 380V input
		U、V、W	Three-phaseAC output
		P、P1	External reactor terminal
			DC bus“-”terminal
			Grounding terminal
CV3100-4T0930M- CV3100-4T6300M		R、S、T	Three-phaseAC 380V input
		U、V、W	Three-phaseAC output
		P、P1	External reactor terminal
			DC bus“-”terminal
			Grounding terminal

(2) The specification of Main circuit cable date, inlet protective circuit breaker QF or fuse as follows:

Model	Circuit breaker (A)	Fuse (A)	Input wire (mm²)	Output wire (mm²)	Control wire (mm²)
CV3100-2S0007M	10	10	1.5	1.5	1
CV3100-2S0015M	20	16	1.5	1.5	1
CV3100-2S0022M	32	20	2.5	2.5	1
CV3100-4T0007M	10	10	1.5	1.5	1
CV3100-4T0015M	10	10	1.5	1.5	1
CV3100-4T0022M	16	10	2.5	2.5	1
CV3100-4T0040M	20	16	2.5	2.5	1
CV3100-4T0055M	32	20	4	4	1
CV3100-4T0075M	40	32	6	6	1
CV3100-4T0110M	63	35	6	6	1
CV3100-4T0150M	63	50	6	6	1
CV3100-4T0185M	100	63	10	10	1
CV3100-4T0220M	100	80	16	16	1
CV3100-4T0300M	125	100	25	25	1
CV3100-4T0370M	160	125	25	25	1
CV3100-4T0450M	200	160	35	35	1
CV3100-4T0550M	200	160	35	35	1
CV3100-4T0750M	250	200	70	70	1
CV3100-4T0930M	315	250	70	70	1
CV3100-4T1100M	400	315	95	95	1
CV3100-4T1320M	400	400	150	150	1
CV3100-4T1600M	630	450	185	185	1
CV3100-4T1850M	630	500	185	185	1

Model	Circuit breaker (A)	Fuse (A)	Input wire (mm ²)	Output wire (mm ²)	Control wire (mm ²)
CV3100-4T2000M	630	560	240	240	1
CV3100-4T2200M	800	630	150×2	150×2	1
CV3100-4T2500M	800	630	150×2	150×2	1
CV3100-4T2800M	1000	800	185×2	185×2	1

(3) Input AC reactor, Output AC Reactor Specifications

frequency inverter capacity (KW)	Input ac reactor		The output ac reactor	
	current (A)	inductance (mH)	current (A)	inductance (uH)
CV3100-4T0300M	60	0.24	63	90
CV3100-4T0370M	75	0.235	80	80
CV3100-4T0450M	91	0.17	100	60
CV3100-4T0550M	112	0.16	125	40
CV3100-4T0750M	150	0.12	160	35
CV3100-4T0930M	180	0.10	200	30
CV3100-4T1100M	220	0.09	224	20
CV3100-4T1320M	265	0.08	280	16
CV3100-4T1600M	300	0.07	315	13
CV3100-4T1850M	360	0.06	400	11
CV3100-4T2000M	360	0.06	400	11
CV3100-4T2200M	400	0.05	560	9
CV3100-4T2500M	560	0.03	600	8
CV3100-4T2800M	560	0.03	600	8
CV3100-4T3150M	640	0.0224	600	6

CV3100 series and MINI series high performance general purpose inverter instruction manual

CV3100-4T3550M	754	0.0196	720	6
CV3100-4T4000M	754	0.0196	720	6
CV3100-4T5000M	1000	0.0141	1000	5
CV3100-4T5600M	1250	0.0113	1250	4
CV3100-4T6300M	1250	0.0113	1250	4

3.5 Diagram of wiring for basic running

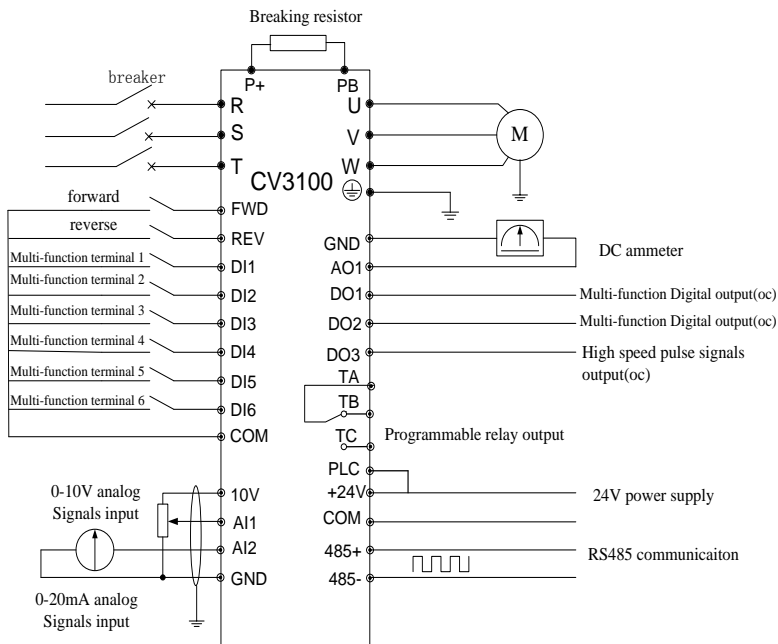

Diagram 3-5 Diagram of wiring for basic running

Applicable inverter: CV3100-4T0007M~CV3100-4T0185M

Remarks:

1. --AI2 is used to select voltage or current signal input, switched by the JP1 on the control panel.
2. --AO1 is used to select Output voltage or current signal, switch by the JP1 on the control panel.
- 3.--DI6 Terminal is used to distinguish high speed pulse signal, D03 could generate high speed pulse signal, but they are non-standard function, should make special description during ordering.

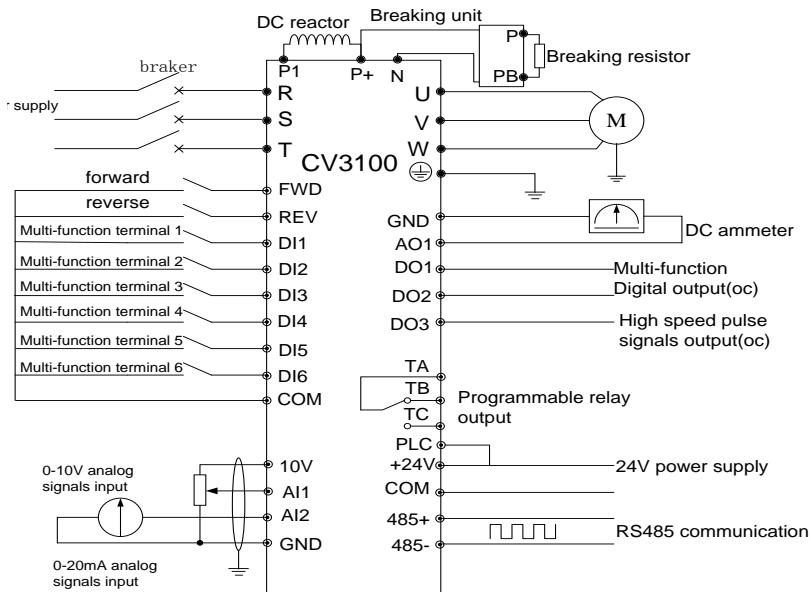

Diagram 3-6 Diagram of wiring for basic running

Applicable inverter: CV3100-4T0220M~CV3100-4T6300M

Remarks:

- 1.--AI2 is used to select voltage or current signal input, switched by the JP1 on the control panel.
- 2.--AO1 is used to select Output voltage or current signal, switch by the JP1 on the control panel.
- 3.--DI6 Terminal is used to distinguish high speed pulse signal, D03 could generate high speed pulse signal, but they are non-standard function, should make special description during ordering

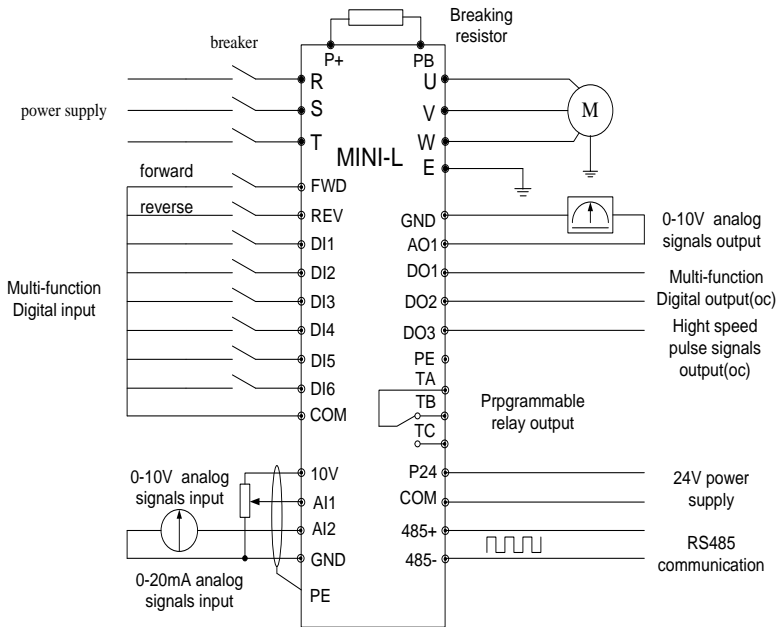

Diagram 3-7 Diagram of wiring for basic running

Applicable inverter: MINI-L-4T0007M-4T0015M/2S0007M-2S0015M

Remarks:

- 1.--AI2 is used to select voltage or current signal input, switched by the JP1 on the control panel.
- 2.--AO1 is used to select Output voltage or current signal, switch by the JP1 on the control panel.
- 3.--DI6 Terminal is used to distinguish high speed pulse signal, D03 could generate high speed pulse signal, but they are non-standard function, should make special description during ordering

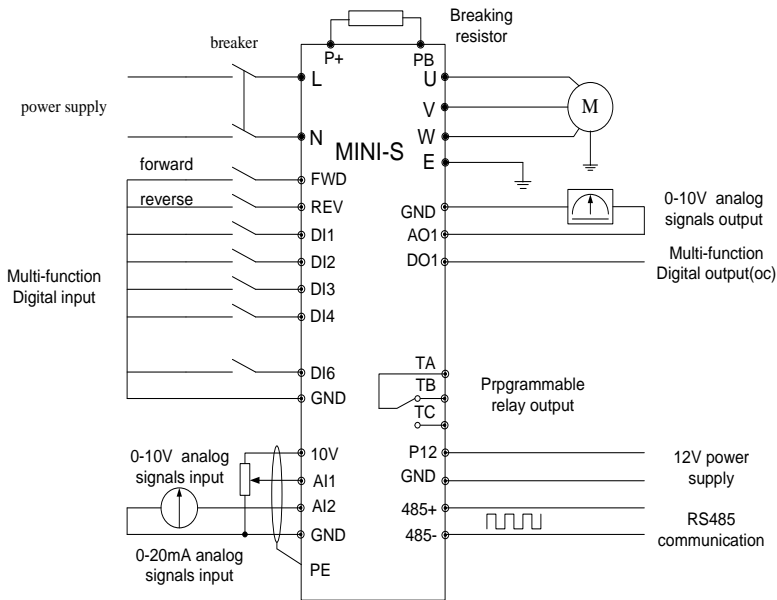

Diagram 3-8 Diagram of wiring for basic running

Applicable inverter: MINI-S-2S0007M-2S0015M

Remarks:

- 1.--AI2 is used to select voltage or current signal input, switched by the JP1 on the control panel.
- 2.--AO1 is used to select Output voltage or current signal, switch by the JP1 on the control panel.
- 3.--DI6 Terminal is used to distinguish high speed pulse signal, but it is non-standard function, should make special description during ordering.

3.6 Control circuit configuration and wiring

3.6.1 Layout of control circuit terminal CN3 as follows(CV3100 series):

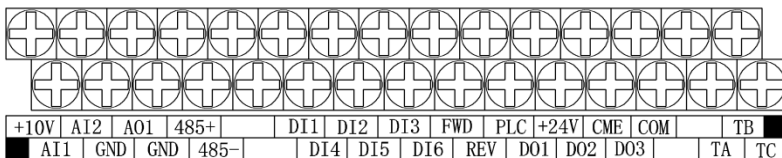

Diagram 3-9 Diagram of control panel terminals arrangement(0.7KW-7.5KW)

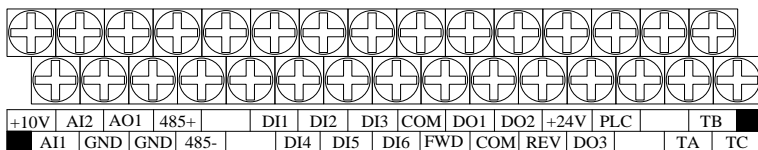

Diagram 3-10 Diagram of control panel terminals arrangement(11KW and above)

3.6.2 CN3 Description of J1 terminal function shown as table 3-4

Type	Terminal no.	Name	Terminal function	Spec.
Communication	485+	RS485 communication interface	RS485 differential signal positive terminal	Standard RS485 communication interface and twisted pair line or shielded line
	485-		RS485 differential signal negative terminal	
Multi-function output terminal	D01 D02	Open collector output terminal	Programmable multi-function digital output terminal is referred to the introduction about output terminal function of terminal function parameter P4.07、 P4.08. (Common terminal: COM)	Optic-coupling isolation output Working voltage:9~30V Max output current:50mA Refer to P078 parameter description for using methods.
	D03	High speed Opto-Couplers output	Output 0-20KHz pulse single, corresponding to output frequency, current, motor rev, voltage etc.	Opto-Couplers isolated output, working voltage range: 24V, max output current: 50mA
Relay output terminal	TA.TB.TC	Fault relay terminal	Normal: TA-TB NC; TA-TC NO Fault: TA-TB NO; TA-TC NC (refer to P4.09)	Rating of contact NO: 5A 250VAC NC: 3A 250VAC

Type	Terminal no.	Name	Terminal function	Spec.
Analog input	AI1	Analog input AI1	Accept the input of analog voltage(Reference ground: GND)	Input voltage range: 0~10V (input impedance: 94KΩ) Resolution: 1/1000
	AI2	Analog input AI2	Accept input of analog current and voltage (Reference ground: GND), diagram 3-9 is referred, select by dip switch on the left side of control terminal.	Input current range: 0~20mA (input impedance: 500Ω) Resolution: 1/1000
Analog output	AO1	Analog output AO1	Provide analog voltage output, can express 8 analog quantity, output frequency as factory default (Reference ground: GND)	Voltage output range: 0~10V/0-20mA; 2~10V/4-20mA
Running control terminal	FWD	Forward running order	Forward/reverse digital command, is referred to introduction of function parameter two-wire and three-wire control function	Optic-coupling isolation input Input impedance: R=2KΩ Max input frequency:200Hz Input voltage: 9~30V Closing available
	REV	Reverse running order		
Multi-function input terminal	DI1	Multi-function input terminal 1	Programmable multi-function digital output terminal is referred to introduction about output terminal function of terminal function parameter (Digital input/output). (Common terminal: COM)	<p>DI1-DI5 } FWD, REV } valid COM }</p>
	DI2	Multi-function input terminal 2		
	DI3	Multi-function input terminal 3		
	DI4	Multi-function input terminal 4		
	DI5	Multi-function input terminal 5		
	DI6	Multi-function input terminal 6		

Type	Terminal no.	Name	Terminal function	Spec.
Power supply	10V	+10V power supply	Provide +10V power supply for external. (Negative end: GND)	Max output current:20mA
	GND	+10V power common terminal	Analog signal and reference ground of +10V power supply	Mutual inner isolation shall be produced between COM and GND.
	COM	+24V power common terminal	Input/output common terminal of digital signal	
	24V	+24VDC	Digital signal power	Max output current: 50mA
	PLC	Multi-function input terminal	DI1-DI6 public terminal	Short circuit with 24V as factory default

Table 3-4 Control plate CN3 terminal function

3.6.3 Wiring of analog input/output terminal

- (1) AI1 terminal accepting input of analog voltage signal, its wiring as follows:
- (2) AI2 terminal accepting input of analog current and voltage signal, its wiring as follows

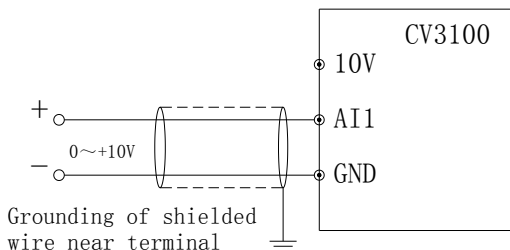

Diagram 3-10 AI1 terminal wiring

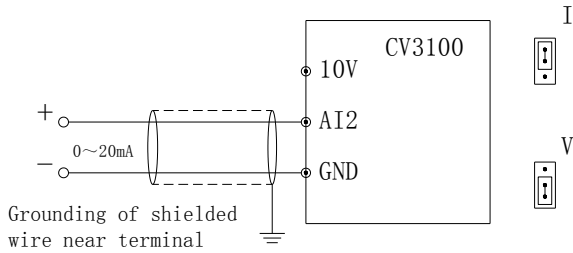

Diagram 3-11 AI2 terminal wiring

(3)Wiring of analog output terminal A01

Analog output terminal A01 with peripheric analog meter can indicate different physical quantities; its wiring is shown as diagram 3-12.

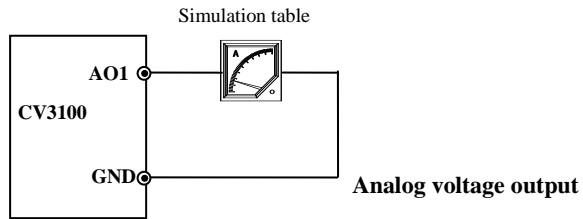

Diagram 3-12 Analog output terminal wiring

Note: Because analog input/output signal is apt to suffer from external interference, the wiring must be provided with the shielded cable; in addition, the cable shall be earthed reliably and as short as possible.

3.6.4 Wiring of communication terminal

Communication interface of CV3100 inverter is the standard RS485 interface.

- (1) The connection between remote-control keyboard and inverter is provided with RS485 interface, when being connected, the remote-control keyboard plug is directly connected to RS485 communication interface. The inverter keyboard and remote-control keyboard can't work simultaneously.
- (2) Connection of inverter RS485 interface and upper machine:

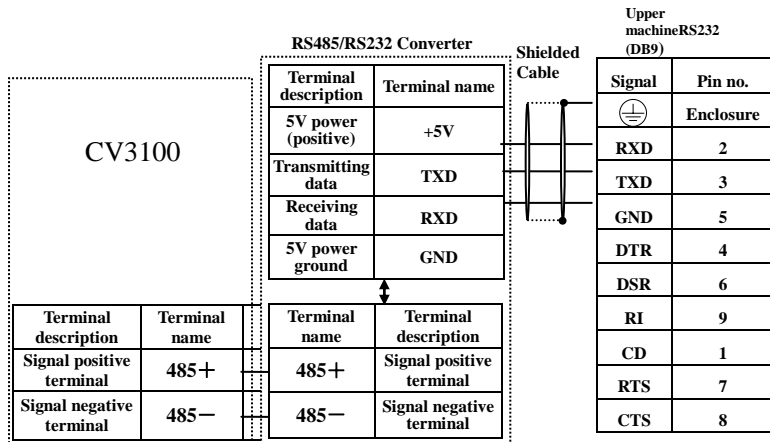
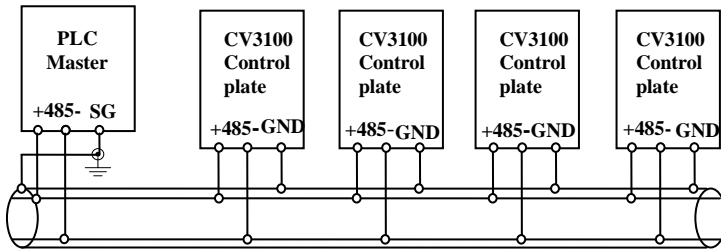
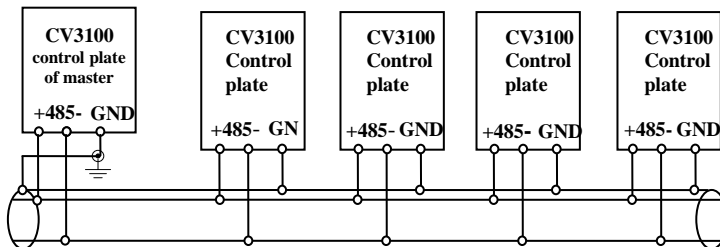

Diagram 3-13 RS485-(RS485/232)-RS232 communication wiring

- (3) As is shown in diagram 3-14 multi inverters may be connected together by RS485 interface, they are controlled by PLC (or upper machine) that is used as master. And as is shown in diagram 3-15 one inverter of them also can be used as master, and other inverters are used as slave. With the addition of inverters, the communication is apt to be interfered more easily, so we suggest the following connecting ways:



**Diagram 3-14 Wiring at communicating PLC with multi inverters
(All the inverters and motors shall be earthed well.)**



**Diagram 3-15 Wiring at communicating among multi inverters
(All the inverter sand motors shall be earthed).**

In case that aforementioned wiring can't provide the normal communication, the following measures may be tried.

- (1) Supply the power for PLC (or upper machine) individually or isolate its power supply.
- (2) Magnetic ring is used on the communicating wire; reduce the carrier frequency of inverter properly.

3.7 Installation guide in line with EMC requirement.

Because the inverter outputs PWM wave, some electromagnetic noise will be made when it operates, in order to prevent inverter interfering outside, this section mainly introduces the methods of installing inverter EMC on the aspect of noise suppression, field wiring, grounding, leakage current, power filter and so on.

3.7.1 Noise suppression

(1) Type of noise

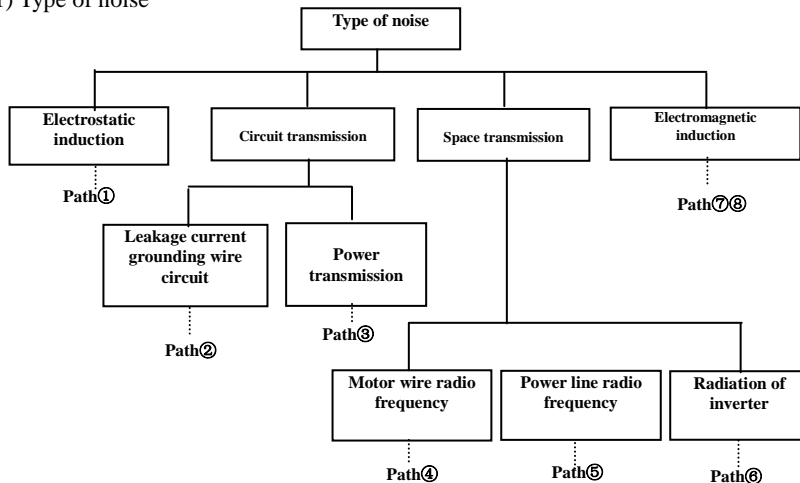

(2) Basic solution against suppressing noise

Table 3-5 Solution against suppressing the interference.

Noise transmission path	Solution
②	When the grounding wire of peripheral equipment with laying wire of inverter forms the closed loop circuit, the leakage current of grounding wire will enable the equipment to produce false operation. At this time, if the equipment isn't earthed, the false operation can be avoided.

<p>③</p>	<p>When the power supply of peripheral equipment and power supply of inverter are provided with the same system, the noise from inverter will transmit with inverting the power line, thus, other equipment in the same system will be affected. The following measures can be used to suppress the noise: Mount an electromagnetic noise filter at input terminal of inverter; other equipment is isolated with isolating transformer or power filter.</p>
<p>④⑤⑥</p>	<p>(1)The equipment and signal wire that is apt to be interfered shall be kept far from the inverter. The signal wire shall be shielded wire. The single end of shielded layer shall be earthed, and kept away the inverter and its input/output wire as far as possible. If the signal wire must be crossed with heavy-current cable, they are must be kept in quadrature.</p> <p>(2)The roots of input/output side of inverter are installed with high-frequency noise filter (common mode chock of ferrite), to suppress the radio frequency interference of power line effectively.</p> <p>(3)The cable of motor shall be put in the shield of large thickness, if installed in the pipe of over 2mm or embedded into cement slot, the power line shall be covered in the metallic pipe, and the shielded wire is used to earth (The motor cable shall be of 4 cores, one end is earthed on the side of inverter, the other is connected to enclosure of motor).</p>
<p>①⑦⑧</p>	<p>Avoid heavy and light current conductors being laid in parallel or tied together, the wiring shall be kept away from the installation equipment of inverter and input/output wire as far as possible. The signal wire and power wire shall be the shielded wire. The equipment with strong electric field or magnetic field shall be kept a certain distance from the installation place of inverter or be kept in quadrature.</p>

3.7.2 Field wiring and grounding

- (1) The line connecting the inverter to motor (U, V, W terminal outgoing wire) shall be avoided laying with the power line in parallel (R, S, T or R, T terminal input wire). And they shall be kept over 30cm gap.
- (2) Three motor lines of inverter U, V, W terminals shall be put in the metallic pipe or metallic wiring groove.
- (3) Control signal line shall be shielded cable; the shielded layer is connected to PE terminal of inverter, and earthed near the single end of inverter side.
- (4) The PE terminal grounding cable can't be provided with other equipment earth wire, it must be connected to grounding plate directly.
- (5) Control signal wire can't be laid with cable of heavy current in parallel or in a near distance (R, S, T or R、 T and U, V, W), and they can't be tied together either, shall be kept over 20-60cm distance (relevant to strong current size). As is shown in diagram 3-16, they shall be laid in vertical if need cross .
- (6) Light-current grounding wires like signal control line, sensor line and strong-current grounding wire must be earthed independently.
- (7) Never connect other equipment to power supply input terminal (R, S, T or R, T) of inverter.

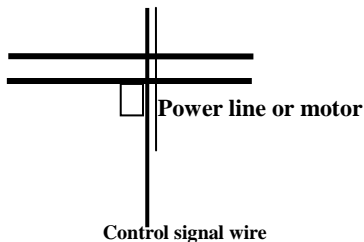

Diagram 3-16 System wiring

Chapter 4 Running and Operating

4.1 Running of inverter

4.1.1 Running order channels

CV3100 inverter has 3 kinds of order channels for controlling running operation such as start, stop, jog, etc.

Operation Panel

Control by keys    on keyboard to start or stop the motor.

Control terminal

Use control terminal FWD, REV, COM to make double-line control, or use one of the terminals of DI1~DI6 and two terminals FWD and REV to make 3-line control

Serial Port

Control start or stop of the inverter through upper machine or other devices which can communicate with the inverter.

Choose order channel by setting function code P0.04

4.1.2 Frequency-provision channels

Under common running mode, CV3100 series inverter has 9 kinds of provision channels:

0: keyboard analog potentiometer provision

1: Digital setting 1 keyboard  ,provision

2: Digital setting 2 terminal UP/DOWN provision

3: Digital setting 3, serial port provision

4: Analog voltage signal AI1 (0-10V) provision

5: Analog current signal AI2 (0-20mA) provision

6: Terminal pulse (0-10KHz) provision

7: Compounding setting

8: External terminal selection

4.1.3 Work State

Work states of CV3100 are classified as Stop State, Run State, Programming State and Failure Alarm State:

Stop State:

If there is no running command after the inverter electrified or after stop command during running state, the inverter enters into waiting state

Running State:

Received run command, the inverter enters into running state

Programming state:

By operating keyboard, modify and set the function parameters of the inverter

Failure Alarm State:

Malfunctions caused in external devices or the inverter or operation errors; the inverter shows relevant malfunctions codes and block outputs.

4.1.4 Run mode

CV3100 inverter has five run modes, followings in turn according to their priorities which are jog run→close-loop run→PLC run→multi-step speed run→common run, shown as diagram 4-1.

0: Jog run

Upon receiving jog run command(for instance, press the  keyboard)during stopping state, the inverter runs at jog frequency(see function code P2.19~P2.21).

1: Closed-loop run

The inverter will come into closed-loop run mode when closed-loop run control effective parameter is set P6.00. Namely carry on PID adjustment to specified value and feedback value and PID adjustor output is inverter output frequency.

2: PLC run

The inverter enters into PLC run mode and runs according to preset through setting PLC effective parameter (P7.00). PLC run mode can be paused by multi-function terminal (function 12).

3: Multi-step speed run

By nonzero combination of multi-function terminal (function 1, 2, 3), choose multi-frequency 1~7(P2.28~P2.34) to run at multi-speed speed

4: Common run

Simple open-loop run mode of general inverter.

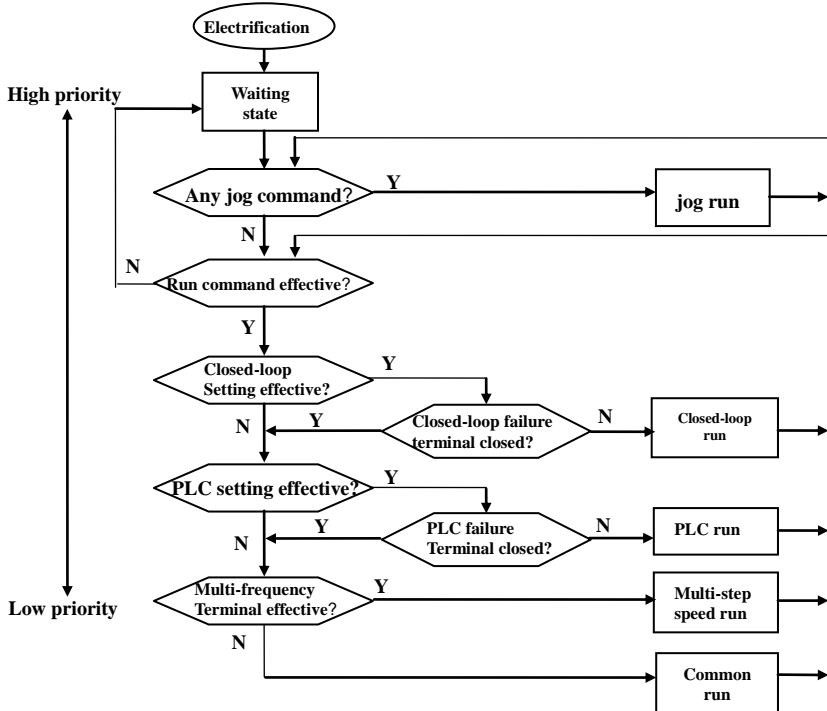

Diagram 4-1 Logic flow chart of CV3100 inverter run state

4.2 Operating and using of keyboard

4.2.1 Keyboard layout

Operating panel and control terminals can control the motor to run, change speed, stop, brake, set the run parameters and external devices. Operating panel is shown as diagram 4-2 and remote-control keyboard is shown as diagram 4-3,4-4.

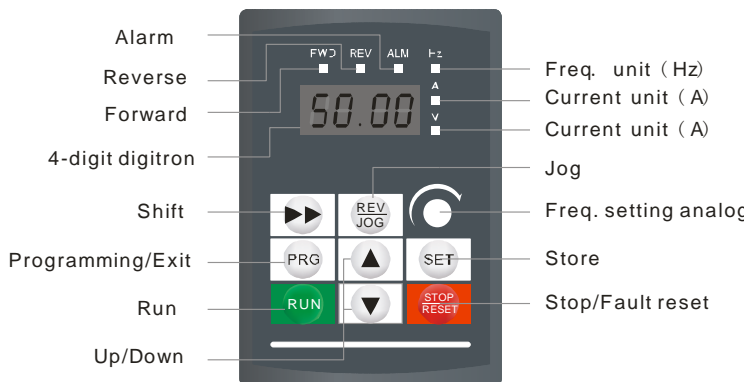

Diagram 4-2 LKD Operating keyboard map

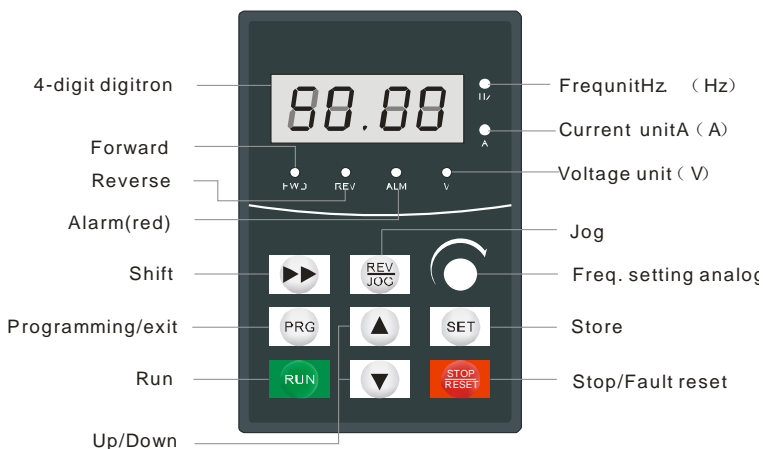

Diagram 4-3 RKB Operating keyboard map



Diagram 4-4 RKD Operating keyboard map

4.2.2 Keyboard function description

There are eight buttons and one keyboard analog POT on the inverter keyboard, they functions are defined as follows:

Item		Function definition
Status indication Fuction	Hz	When the LED display content is frequency data, the light is on
	A	When the LED display content is current data, the light is on
	V	When the LED display content is voltage data, the light is on
	ALM	When the inverter current limiting operation or pressure limiting operation or the failure occurs,the light is on
	FWD	When the inverter is forward running, this light is on
	REV	When the inverter is reverse running,this light is on
	Hz&A	When the LED display content is rotational speed, the two lights is on at the same time
	Hz&V	When the LED display content is percentage, the two lights is on at the same time







	A&V	When the LED display content is liner velocity, the two lights is on at the same time
	Hz&A&V	When the LED display content is temperature, the three lights is on at the same time
Key function		Run key: Inverter operation instruction of channel control mode is set to the panel([P0.04=0]), enter into run mode under keyboard mode. Inverter runs according to the specified acceleration/deceleration curve to the rated power.
		Jog/ Reverse key: This function is decided by parameter P0.23 When P0.23=0, reverse running. When P0.23=1, Jog running.
		Stop/Reset key: In common run status the inverter will stop according to set mode after this key is pressed if run command channel is set as panel effective mode([P0.04=0]). The inverter will reset and resume normal stop status after this key is pressed when the inverter is in malfunction status.
		Mode switch key: Used to change the operation mode of the operation panel. When press this button, control panel will enter parameters query mode to query operation parameters. Press this button again to parameters modification mode.
		Confirm key: confirm the current stage or parameters storage(store into internal storage)
		Data modification keys: Used to modify data function code or parameters. In condition monitoring mode, if the specified frequency channel is set to the panel digital set mode([P0.01=1]), press this key instructions directly modifying frequency values
		Shift/Monitor key: Choose the digit of the data which is to be set and modified when the inverter is in edition status; switch monitor parameter to be shown when the inverter is in other statuses. In condition monitoring mode, directly press this button to parameter query mode which could cycling show the content of d-00-d-28. Note: this query method will firstly display monitor code, 2 seconds later for detailed contents.

Diagram 4-1

The operation mode of the keyboard and switch state

According to different display content and receive instruction, there are 5 different working mode.

① Status monitoring mode

This is normal working mode. Under any circumstance, if there is no any key input for 1 minute, the keypad panel will recur to this mode automatically.

② Monitoring examining mode

Under this mode, press ▲/▼ key to choose the state of data, such as output voltage, output frequency, output current and so on. d-00 is the defaulted parameters for monitoring by system. Choose function parameter P3.04,P3.05 to monitor other parameters for a long time.

③ Functional parameters examining mode

Under this mode, press ▲/▼ key or ▶ key to choose parameters need to be modified or selected, such as P0.08,P5.02.

④ Functional parameters under modification mode

⑤ Digital setting frequency under modification mode

When P0.01 is set, under condition monitoring mode, press ▲/▼ key to enter for modifying.

The switch during them shown as following:

① → Press PRG key → ② → Press PRG key → ③ → Press SETS key → ④

① Press ▲/▼ key → ⑤

(P0.01 set to frequency given by digital setting)

4.3 Inverter electrification

4.3.1 Check before electrification

Please carry on wiring based on operation requirement provided in “Inverter wiring” of this manual.

4.3.2 Initial electrification

Close input side AC power supply switch after correct wiring and power supply confirmed, electrify the inverter and keyboard LED display starting status, contactor closes normally, and LED displaying set frequency shows that electrification is finished. First electrification operation process is shown as diagram 4-4.

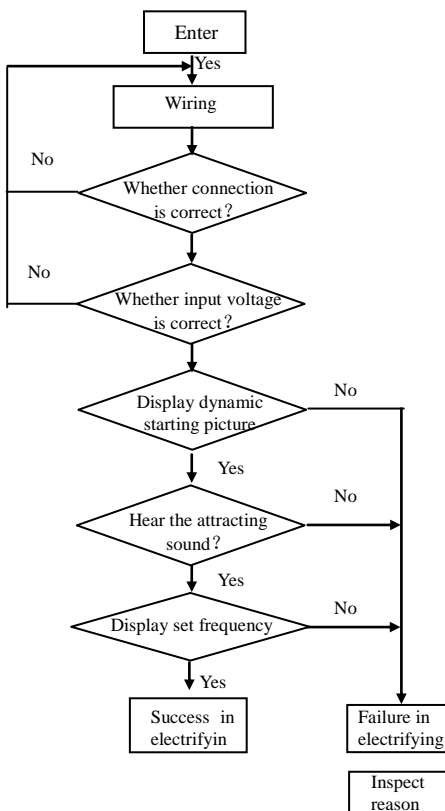

Diagram 4-4 Flow chart of inverter initially electrified operation

Chapter 5 Function parameter table



5.1 Introduction of symbol

@—Parameter function is non-standard option one;

×—Parameter can not be changed in process of running;

√—Parameter can be changed in process of running;

5.2 Function parameter table

Basic Parameter						
Function Code	Name & Definition	Set Range	Minimum Unit	Factory Default	Communication Address	Modify
P0.00	Control mode	0: Sensorless vector control 1: V/F control	1	1	0000H	×
P0.01	Frequency input channel selection	0: Panel potentiometer setting 1: Keypad digit setting by  /  or digital encoder 2: UP/DOWN terminal digit setting 3: Communication setting 4: AI1 analog voltage signal setting (0~10V) 5: AI2 analog current signal setting (0~20mA) 6: Terminal pulse (0~10KHZ) 7: Compounding setting (AI1+AI2) 8: External terminal selection	1	0	0001H	○
P0.02	Digital frequency control	LED single unit: memory during power off 0: storage 1: not storage LED decimal unit: holding during stop status 0: holding 1: not holding LED hundred & thousand unit: Reserved (Note: Only valid to P0.01=1,2, 3)	1	00	0002H	○
P0.03	Frequency setting	0.00~Upper limit frequency	0.01Hz	50.00Hz	0003H	○
P0.04	Running command selection	0: Keypad control available 1: External terminal control available 2: Serial port control available	1	0	0004H	○
P0.05	Run direction setting	0: Forward 1: Reverse 2: Reverse prevent	1	0	0005H	○
P0.06	Upper limit frequency	{P0.07} ~400.00Hz	0.01Hz	50.00Hz	0006H	×

CV3100 series and MINI series high performance general purpose inverter instruction manual

Function Code	Name & Definition	Set Range	Minimum Unit	Factory Default	Communication Address	Modify
P0.07	Lower limit frequency	0.00~【P0.06】	0.01Hz	00.00Hz	0007H	×
P0.08	Basic running frequency	1.00~Upper limit frequency	0.01Hz	50.00Hz	0008H	×
P0.09	Max.output voltage	200~500V 100~250V	1	380V 220V	0009H	×
P0.10	Model choose	0: G type (Constant torque load) 1: FP type (Fan, pump load)	1	0	000AH	×
P0.11	Torsion rising selection	0: Manual 1: Automatic	1	0	000BH	×
P0.12	Torsion rising setting	0.0~30.0% Note: available when F0.11=0	0.1		000CH	○
P0.13	Rotation deviation frequency compensation	0.0~150.0%	0.1	0.0	000DH	○
P0.14	Acceleration time 1	0.1~3600S Accel&Decel time unit reference P3.09)	0.1		000EH	○
P0.15	Deceleration time 1		0.1		000FH	○
P0.16	V/F curve setting	0: constant torsion curve 1: decreasing torsion curve 1 (1.7 hypo-power) 2: decreasing torsion curve 2 (2.0 hype-power) 3: Customer self-defined V/F curve mode (determined by P0.17~P0.22)	1	0	0010H	×
P0.17	V/F freq. value F1	0.00~frequency value F2	0.01Hz	12.50Hz	0011H	×
P0.18	V/F volt. value V1	0.0~voltage value V2	0.1%	25.0%	0012H	×
P0.19	V/F freq. value F2	Freq. value F1~Freq. value F3	0.01Hz	25.00Hz	0013H	×
P0.20	V/F volt. value V2	Volt. value V1~Volt. value V3	0.1%	50.0%	0014H	×
P0.21	V/F freq. value F3	Freq. value F2~basic running frequency	0.01Hz	37.50Hz	0015H	×
P0.22	V/F volt. Value V3	Voltage value V2~100.0%	0.1%	75.0%	0016H	×
P0.23	REV/JOG function selection	0: REV 1: JOG	1	1	0017H	○

Motor and Vector control Parameter						
Function Code	Name & Definition	Set Range	Minimum Unit	Factory Default	Communication Address	Modify
P1.00	Motorrated voltage	380V: 200~500V 220V: 100~250V	1V	380V 220V	0100H	○
P1.01	Motor rated current	0.1~600.0A	0.1A		0101H	○
P1.02	Motor rated rev.	300~3000RPM	1RPM		0102H	×
P1.03	Motor rated freq.	1.00~400.00Hz	0.01Hz	50.00Hz	0103H	×
P1.04	Motor no-loading current	0.1~500.0A	0.1A		0104H	○
P1.05	Motor stator resistance	0.001~10.000Ω	0.001		0105H	×
P1.06	Motor rotor resistance	0.001~10.000Ω	0.001		0106H	×
P1.07	Motor inductance	0.01~600.00mH	0.01mH		0107H	×
P1.08	Motor mutual inductance	0.01~600.00mH	0.01mH		0108H	×
P1.09	Reserved					
P1.10	Rotation deviation compensation	0.50-2.00	0.01	1.00	010AH	○
P1.11	Pre-excitation of-motor selection	0: conditionally available 1: available all along	1	0	010BH	×
P1.12	Pre-excitation continuing time	0.1~10S	0.1	0.2S	010CH	×
P1.13	Motor auto tuning	0: no action 1: statictuning (available P0.00=0)	1	0	010DH	×
P1.14	Auto speed regulation (ASR) proportion (P) gain	0.01~5.00	0.01	1.00	010EH	○
P1.15	ASR integration (I) time constant	0.01~10.00S	0.01s	2.00S	010FH	○

Auxiliary Parameter						
Function Code	Name & Definition	Set Range	Minimum Unit	Factory Default	Communication Address	Modify
P2.00	Starting mode	0: start with starting freq. 1: speed tracking start	1	0	0200H	×
P2.01	Starting freq.	0.00~10.00Hz	0.01Hz	1.00Hz	0201H	○
P2.02	Starting freq. duration	0.0~10.0s	0.1s	0.0s	0202H	×
P2.03	DC braking current level at starting	0.0~100.0%	0.1%	0.0%	0203H	○
P2.04	DC braking time at starting	0.1~30.0s (0: immovability of DC braking)	0.1s	0.0s	0204H	×
P2.05	Accel.&Decel .way	0: Beeline 1: S-curve	1	0	0205H	○
P2.06	S-curve starting duration proportion	10.0~40.0%	0.1%	20.0%	0206H	×
P2.07	S-curve ascend/descend duration proportion	10.0~80.0%	0.1%	60.0%	0207H	×
P2.08	AVR function	0: inhibitive 1: allowable	1	1	0208H	×
P2.09	Automatic energy saving operation	0: inhibitive 1: allowable	1	0	0209H	×
P2.10	Forward and reverser Rotation dead-zone interval	0.1~10.0s	0.1s	0.0s	020AH	×
P2.11	Stop mode	0: ramp to stop 1: coast to stop	1	0	020BH	×
P2.12	Starting frequency for DC braking during stop	0.00~20.00Hz	0.01Hz	0.00Hz	020CH	○
P2.13	DC braking current during stop	0.0~100.0%	0.1%	0.0%	020DH	○
P2.14	DC braking time during STOP	0.1~30.0s (0: No action during DC Braking)	0.1s		020EH	×

CV3100 series and MINI series high performance general purpose inverter instruction manual

Function Code	Name & Definition	Set Range	Minimum Unit	Factory Default	Communication Address	Modify
P2.15	Power-off restart setting	0: inhibitive 1: normal start 2: speed trucking start	1	1	020FH	×
P2.16	Restart waiting time after power-off	0.0~20.0s	0.1s	0.5s	0210H	×
P2.17	Failure self-reset times	0~10	1	0	0211H	×
P2.18	Failure self-reset interval	0.5~25.0s	0.1s	3.0s	0212H	×
P2.19	Jog running freq.	0.00~50.00Hz	0.01Hz	10.00Hz	0213H	○
P2.20	Jog accel. time	0.1~3600srefer to P3.09	0.1s		0214H	○
P2.21	Jog decel. time		0.1s		0215H	○
P2.22	Accel. time 2	0.1~3600srefer to P3.09	0.1s		0216H	○
P2.23	Decel. Time 2		0.1s		0217H	○
P2.24	Accel. time 3	0.1~3600srefer to P3.09	0.1s		0218H	○
P2.25	Decel. Time 3		0.1s		0219H	○
P2.26	Accel. time 3	0.1~3600srefer to P3.09	0.1s		021AH	○
P2.27	Decel. Time 3		0.1s		021BH	○
P2.28	The 1st step freq.	0.00~Upper limit freq.	0.01Hz	5.00Hz	021CH	○
P2.29	The 2nd step freq.	0.00~Upper limit freq.	0.01Hz	10.00Hz	021DH	○
P2.30	The 3rd step freq.	0.00~Upper limit freq.	0.01Hz	15.00Hz	021EH	○
P2.31	The 4th step freq.	0.00~Upper limit freq.	0.01Hz	20.00Hz	021FH	○
P2.32	The 5th step freq.	0.00~Upper limit freq.	0.01Hz	25.00Hz	0220H	○
P2.33	The 6th step freq.	0.00~Upper limit freq.	0.01Hz	30.00Hz	0221H	○
P2.34	The 7th step freq.	0.00~Upper limit freq.	0.01Hz	40.00Hz	0222H	○

CV3100 series and MINI series high performance general purpose inverter instruction manual

Function Code	Name & Definition	Set Range	Minimum Unit	Factory Default	Communication Address	Modify
P2.35	Reserved					
P2.36	Skip freq.1	0.00~Upper limit freq.	0.01Hz	0.00Hz	0224H	○
P2.37	Skip freq. band 1	0.0~10.0Hz	0.01Hz	0.00Hz	0225H	○
P2.38	Skip freq.2	0.00~Upper limit freq.	0.01Hz	0.00Hz	0226H	○
P2.39	Skip freq. band 2	0.0~10.0Hz	0.01Hz	0.00Hz	0227H	○
P2.40	Skip freq.3	0.00~Upper limit freq.	0.01Hz	0.00Hz	0228H	○
P2.41	Skip freq. band 3	0.0~10.0Hz	0.01Hz	0.00Hz	0229H	○
P2.42	Carrier freq. selection	1.0~12.0KHz	0.1KHz		022AH	○
P2.43	Carrier control method	0: fixed carrier 1: automatic adjustment	1	1	022BH	○
User Managing Interface Parameter						
P3.00	LCD language selection	0: Chinese 1: English	1	0	0300H	○
P3.01	Parameter initialization	0: disabled 1: revert to factory setting 2: eliminate fault record	1	0	0301H	×
P3.02	Parameter read-in protection	0: allowed to modify all parameters (some of which can not be changed during inverter running) 1: only allow to change the frequency 2: forbidden to modify all parameters	1	0	0302H	○
P3.03	Factory password	0~9999	1	0	0303H	○
P3.04	Monitoring parameter 1 selection	0~18	1	0	0304H	○
P3.05	Monitoring parameter 2 selection	0~18	1	1	0305H	○
P3.06	Linear velocity quotiety	0.01~100.0	0.01	1.00	0306H	○
P3.07	Close loop display quotiety	0.01~100.0	0.01	1.00	0307H	○

Function Code	Name & Definition	Set Range	Minimum Unit	Factory Default	Communication Address	Modify
P3.08	Software edition	0~99.99	0.01		0308H	×
P3.09	Accel. & Decel. time unit	0: Second 1: Minute	1	0	0309H	○
Digital Input and Output Parameter						
P4.00	Input terminal DI1 function	0: Leave control terminal unused	1	0	0400H	×
P4.01	Input terminal DI2 function	1: Multi-step speed definition 1 2: Multi-step speed definition 2 3: Multi-step speed definition 3 4: Accel. & Decel. 1 5: Accel. & Decel. 2	1	0	0401H	×
P4.02	Input terminal DI3 function	6: Freq. channel selection 1 7: Freq. channel selection 2 8: Freq. channel selection 3	1	0	0402H	×
P4.03	Input terminal DI4 function	9: Forward jog control 10: Reverse jog control 11: Free stop control	1	0	0403H	×
P4.04	Input terminal DI5 function	12: Freq. increasing command 13: Freq. decreasing command 14: Peripheral failure input	1	0	0404H	×
P4.05	Input terminal DI6 function	15: Three-line operation control 16: DC braking command 17: Counter reset signal input 18: Counter trigger signal input (Available to DI6) 19: Exterior pulse input (Available to DI6) 20: Exterior reset signal input 21: UP/DOWN terminal frequency reset 22: PID operation available 23: Programmable multi-step speed running available 24: Wobbling frequency operation available selection 25: Wobbling freq. status reset 26: Exterior stop command 27: Inverter running forbidden command 28: Reserve 29: Command channel input switched to terminal 30: Freq. input channel switched to AI2 31: Timer start 32: Timer reset	1	0	0405H	×

CV3100 series and MINI series high performance general purpose inverter instruction manual

Function Code	Name & Definition	Set Range	Minimum Unit	Factory Default	Communication Address	Modify
P4.06	FWD/REV terminal control method	0: Two-line control mode 1 1: Two-line control mode 2 2: Three-line control mode 1 3: Three-line control mode 2 (reserved)	1	0	0406H	×
P4.07	Open collector terminal DO1 output	0: Inverter running indication 1: Freq./speed arrival signal (FAR) 2: Freq./speed detecting signal (FDT)	1	0	0407H	○
P4.08	Open collector terminal DO2 output	3: Inverter zero speed running indication 4: Peripheral failure stop 5: Output freq. arriving at the upper limit 6: Output freq. arriving at the lower limit	1	1	0408H	○
P4.09	Programmable relay output	7: Programmable multi-step speed circular running finished 8: Inverter overload alarming signal 9: Inverter starts to run in train 10: Counter checkout signal output 11: Counter reset signal output 12: Inverter failure 13: less-voltage stopping 14: Wobbling frequency fluctuation limit 15: Programmable multi-step speed running finished. 16: Reserved 17: Timing to output	1	12	0409H	○
P4.10	FDT level setting	0.00Hz~Upper limit frequency	0.01Hz	10.00Hz	040AH	○
P4.11	FDT lag value	0.0~30.00Hz	0.1Hz	1.00Hz	040BH	○
P4.12	Freq. arrival FAR checkout width	0.00Hz~15.0Hz	0.01Hz	5.00Hz	040CH	○
P4.13	Overload pre-alarm checkout level	20~120%	1%	100%	040DH	○
P4.14	Overload pre-alarm delayed time	0.0~15.0s	0.1s	1.0s	040EH	×
P4.15	Counter reset value	【P4.16】~60000	1	1	040FH	×
P4.16	Counter checkout value	0~【P4.15】	1	1	0410H	×

Analog Input and Output Parameter						
Function Code	Name & Definition	Set Range	Minimum Unit	Factory Default	Communication Address	Modify
P5.00	AI1 input voltage of lower limit	0.0~【P5.01】	0.1V	0.0V	0500H	○
P5.01	AI1 input voltage of upper limit	【P5.00】~10.0V	0.1V	10.0V	0501H	○
P5.02	AI2 input current of lower limit	0.0~【P5.03】	0.1mA	0.0mA	0502H	○
P5.03	AI2 input current of upper limit	【P5.02】~20.0mA	0.1mA	20.0mA	0503H	○
P5.04	Pulse input frequency of lower limit	0.0~【P5.05】	0.1KHz	0.0KHz	0504H	○
P5.05	Pulse input frequency of upper limit	【P5.04】~20.0kHz	0.1KHz	10.0KHz	0505H	○
P5.06	Setting frequency to minimum input	0.0Hz~upper frequency	0.01Hz	0.00Hz	0506H	○
P5.07	Setting frequency to maximum input	0.0Hz~upper frequency	0.01Hz	50.00Hz	0507H	○
P5.08	Delayed time to analog input signal	0.1~5.0s	0.1s	0.5s	0508H	○
P5.09	AO1 multi-functional analog output terminal function selection	0: Output frequency 1: Setting frequency 2: Output current 3: Motor rev. 4: Output voltage 5: Bus voltage 6: PIDrivation 7: PID feedback	1	0	0509H	○
P5.10	DO3 multi-functional pulse output terminal function selection		1	2	050AH	○

CV3100 series and MINI series high performance general purpose inverter instruction manual

Function Code	Name & Definition	Set Range	Minimum Unit	Factory Default	Communication Address	Modify
P5.11	AO1 gain setting	20~200%	1%	100%	050BH	○
P5.12	Reserved				050CH	
P5.13	DO3 gain setting	20~200%(Rating 10KHZ)	1%	100%	050DH	○
P5.14	Reserved				050EH	
P5.15	Compounding specified channel setting	<p>LED single digit:Operand 1 0: Keypadpotentiometer; 1: Digit setting 2: reserved 3: Communication setting 4: AI1 5: AI2 6: Terminal pulse.</p> <p>LED tens digit: Operand 2 0: Keypadpotentiometer 1: Digit setting 2: reserved 3: Communication setting 4: AI1 5: AI2 6: Terminal pulse</p> <p>LED Hundreds digit: Operand 3 0: Keypadpotentiometer 1: Digit setting 2: reserved 3: Communication setting 4: AI1 5: AI2 6: Terminal pulse</p> <p>LED Thousands digit: Reserved</p>	1	000	050FH	×
P5.16	Compounding specified arithmetic setting	<p>LED single digit: Arithmetic 1 0: Addition 1: Subtraction 2: Absolute value (Subtraction) 3: Choose Maximum. 4: Choose Minimum.</p> <p>LED tens digit: Arithmetic 2 0: Addition 1: Subtraction 2: Absolute value (Subtraction) 3: Choose Maximum. 4: Choose Minimum. 5: Operand 3 not be concerned with operation</p> <p>LED Hundreds & thousands digit: Reserved</p>	1	00	0510H	○

Process PID Control Parameter						
Function Code	Name & Definition	Set Range	Minimum Unit	Factory Default	Communication Address	Modify
P6.00	PID action setting	LED single digit: Function setting 0: Close 1: Open LED tens digit: PIDavailability selection 0: Automatic availability 1: Manual availability by defining of multi-function terminal LED Hundreds & thousands digit: Reserved	1	00	0600H	×
P6.01	PID specified channel selection	0: Keypad potentiometer 1: Digit setting 2: Reserved 3: Reserved	1	1	0601H	×
P6.02	PID feedback channel selection	4: AI1 provision 5: AI2 provision 6: Terminal pulse 7: AI1+AI2 8: AI1-AI2 9: MIN {AI1,AI2} 10:MAX {AI1,AI2}	1	4	0602H	×
P6.03	Specified digital quantity setting	0.00~10.00V	0.01V	0.00V	0603H	○
P6.04	Gain of feedback channel	0.01~10.00	0.01	1.00	0604H	○
P6.05	Polarity of feedback channel	0: Positive 1: Negative	1	0	0605H	×
P6.06	Proportion gain P	0.01~10.00	0.01	1.00	0606H	○
P6.07	Integral time Ti	0.1~200.0s	0.1s	1.0s	0607H	○
P6.08	Differential coefficient time Td	0.0: No 0.1~10.0s	0.1s	0.0s	0608H	○
P6.09	Sampling time T	0.00: Automatic 0.01~10.00s	0.01s	0.00s	0609H	○
P6.10	Deviation margin	0.0~20.0%	0.1%	0.0%	060AH	○
P6.11	Closed-loop presetting frequency	0.0~Upper limit frequency	0.01Hz	0.00Hz	060BH	○

Function Code	Name & Definition	Set Range	Minimum Unit	Factory Default	Communication Address	Modify
P6.12	Duration of presetting frequency	0.0~6000.0s	0.1s	0.0s	060CH	×
P6.13	Sleeping threshold	0.0~10.00V	0.01	10.00V	060DH	○
P6.14	Waking threshold	0.0~10.00V	0.01	0.00V	060EH	○
P6.15	Sleep/Wake waiting time	0.1~600.00S	0.1	300.0S	060FH	○
Programmable Running Parameter						
P7.00	Programmable running control (includes simple PLC and wobbling frequency running)	<p>LED single digit: Running mode selection 0: No action 1: Single circulation(Simple PLC) 2: Continuous circulation (Simple PLC) 3: Holding ultimate value after single circulation (Simple PLC) 4: Wobbling frequency running</p> <p>LED tens digit: Programmable multi-step speed (PLC) runningavailability selection 0: Automatic availability 1: Manual availability by defining multi-function terminal</p> <p>LED Hundreds digit: Wobbling frequency running availability mode 0: Automatic availability 1: Manual availability by defining of multi-function terminal.</p> <p>LED thousands digit: Reserved</p>	1	000	0700H	×
P7.01	Stage 1 running time	0.0~6000.0s	0.1s	10.0s	0701H	○
P7.02	Stage 2 running time	0.0~6000.0s	0.1s	10.0s	0702H	○
P7.03	Stage 3 running time	0.0~6000.0s	0.1s	10.0s	0703H	○
P7.04	Stage 4 running time	0.0~6000.0s	0.1s	10.0s	0704H	○

CV3100 series and MINI series high performance general purpose inverter instruction manual

Function Code	Name & Definition	Set Range	Minimum Unit	Factory Default	Communication Address	Modify
P7.05	Stage 5 running time	0.0~6000.0s	0.1s	10.0s	0705H	○
P7.06	Stage 6 running time	0.0~6000.0s	0.1s	10.0s	0706H	○
P7.07	Stage 7 running time	0.0~6000.0s	0.1s	10.0s	0707H	○
P7.08	Reserved					
P7.09	Multi-step speed running direction 1	LED single digit: Stage 1 direction 0: Forward 1: Reverse LED tens digit: Stage 2 direction 0: Forward 1: Reverse LED hundreds digit: Stage 3 direction 0: Forward 1: Reverse LED thousands digit: Stage 4 direction 0: Forward 1: Reverse	1	0000	0709H	○
P7.10	Multi-step speed running direction 2	LED single digit: Stage 5 direction 0: Forward 1: Reverse LED tens digit: Stage 6 direction 0: Forward 1: Reverse LED hundreds digit: Stage 7 direction 0: Forward 1: Reverse LED thousands digit: Reserved	1	000	070AH	○

CV3100 series and MINI series high performance general purpose inverter instruction manual

Function Code	Name & Definition	Set Range	Minimum Unit	Factory Default	Communication Address	Modify
P7.11	Wobbling frequency running mode	<p>LED single digit: Reserved</p> <p>LED tens digit: Wobbling range control 0: Fixed 1: Variable</p> <p>LED hundreds digit: Selection of wobbling frequency start up mode after power off 0: Start up according to memory before stop 1: Restart</p> <p>LED thousands digit: Selection of Wobbling frequency status storage after power off 0: Storing after power off 1: Not storing</p>	1	000	070BH	×
P7.12	Wobbling pre-setting frequency	0.00Hz~Upper limit freq.	0.01Hz	10.00Hz	070CH	○
P7.13	Wobbling presetting frequency waiting time	0.0~3600.0s	0.1s	0.0s	070DH	×
P7.14	Wobbling frequency width	0.0~50.0%	0.1%	10.0%	070EH	○
P7.15	Skip frequency	0.0~50.0% (relate to wobbling frequency range)	0.1%	10.0%	070FH	○
P7.16	Wobbling freq. period	0.1~3600.0s	0.1s	10.0s	0710H	○
P7.17	Triangle wave risetime	0.0~100.0% (Wobbling period)	0.1%	50.0%	0711H	○
P7.18	Norm of central wobbling frequency	0.00Hz~Upper limit freq.	0.01Hz	10.00Hz	0712H	○

Communication Parameter						
Function Code	Name & Definition	Set Range	Minimum Unit	Factory Default	Communication Address	Modify
P8.00	Local communication address	0: Host station 1~31: Ancillary station	1	1	0800H	×
P8.01	Communication scheme	LED single digit: Baud rate selection 1: 2400BPS 2: 4800BPS 3: 9600BPS 4: 19200BPS 5: 38400BPS LED tens digit: Data form 0: No checkout 1: Even checkout 2: Odd checkout LED hundreds digit: Reserved LED thousands digit: 0: return information when modify data 1: no return information when modify data	1	013	0801H	×
P8.02	Communicating overtime checkout time	0.0~100.0s	0.1s	10.0s	0802H	×
P8.03	Response delay	0~1000ms	1ms	5ms	0803H	×
P8.04	Linkage proportion setting	0.01~10.00	0.01	1.00	0804H	○
Protection Function						
P9.00	Motor overload stall prevention factor	30%~110%	1%	105%	0900H	○
P9.01	Low voltage prevention level	360~480V(380V machine type)	1V	400V	0901H	○
P9.02	Over voltage prevention level	660~760V(380v machine type)	1V	700V	0902H	○
P9.03	Over current stall prevention level	80%~220%	1%	180%	0903H	○

Senior Function						
Function Code	Name & Definition	Set Range	Minimum Unit	Factory Default	Communication Address	Modify
PA.00	Zero frequency running threshold	0.00~50.00Hz	0.01Hz	0.00Hz	0A00H	○
PA.01	Zero frequency hysteresis	0.00~50.00Hz	0.01Hz	0.00Hz	0A01H	○
PA.02	Energy consuming braking initial voltage	600~750V	1V	700V	0A02H	○
PA.03	Energy consuming braking action percentage	10~100%	1%	50%	0A03H	○
PA.04	Cooling fan control	0: Automatic control 1: Working during power on	1	0	0A04H	○
PA.05	UP/DOWN terminal modifying speed	0.01Hz~100.0Hz/S	0.01Hz/S	1.00Hz/S	0A05H	○
PA.06	Over modulation enabling	0: Forbidden 1: Allowable	1	0	0A06H	×
PA.07	Timer value setting	0~65536S	1S	0	0A07H	×
PA.08	The Rang of AO1 output	0: 0~10V/0~20mA 1: 2~10V/4~20mA	1	0	0A08H	×
PA.09	Reserved					
PA.10	Reserved					
PA.11	Reserved					
PA.12	Reserved					

Monitoring Parameter		
Monitoring Code	Description	Communication Address
D-00	Output frequency (Hz)	0D00H
D-01	Setting frequency (Hz)	0D01H
D-02	Output current (A)	0D02H
D-03	Output voltage (V)	0D03H
D-04	Motor Rev. (RPM/min)	0D04H
D-05	Running linear speed(m/s)	0D05H
D-06	Setting linear speed (m/s)	0D06H
D-07	Bus voltage (V)	0D07H
D-08	Input voltage (V)	0D08H
D-09	PID setting value	0D09H
D-10	PID feedback value	0D0AH
D-11	Analog input AI1(V)	0D0BH
D-12	Analog input AI2(A)	0D0CH
D-13	Pulse input frequency (KHz)	0D0DH
D-14	Input terminal status	0D0EH
D-15	Radiator temperature (°C)	0D0FH
D-16	IGBT temperature (°C)	0D10H
D-17	Current count value	0D11H
D-18	Count value set	0D12H
D-19	First failure record	0D13H
D-20	Second failure record	0D14H
D-21	Third failure record	0D15H
D-22	Output frequency during first failure(Hz)	0D16H
D-23	Frequency setting before first failure(Hz)	0D17H

CV3100 series and MINI series high performance general purpose inverter instruction manual

Monitoring Code	Description	Communication Address
D-24	Output current during first failure(A)	0D18H
D-25	Output voltage during first failure (V)	0D19H
D-26	Bus voltage during first failure(V)	0D1AH
D-27	IGBT temperature during first failure(℃)	0D1BH
D-28	Soft edition	0D1CH
Fault Code		
Fault code	Description	Communication Address
Er00	Over current during accelerating operation	0E00H(High eight)
Er01	Over current during decelerating operation	
Er02	Over current during steady state operation	
Er03	Over voltage during accelerating operation	
Er04	Over voltage during decelerating operation	
Er05	Over voltage during steady state operation	
Er06	Over voltage during stopping	
Er07	Under voltage during running	
Er08	Phase failure of power input	
Er09	Power IGBT module failure	
Er10	Overheat of radiator	
Er11	Overload of inverter	
Er12	Overload of motor	
Er13	Peripheral equipment fault	
Er14	RS485 communication fault	
Er15	Reserved	
Er16	Incorrect current detection	
Er17	Fault of communication between keypad and control panel	
Er18	CPU failure	
Er19	Reserved	

Chapter 6 Specification of function

6.1 Basic parameter

P0.00	Control mode		Factory setting	1
	Setting range	0	Sensorless vector control (SVC)	
		1	V/F control	

0: Open-loop vector control

Namely Sensorless vector control (SVC), it is applied to the high-performance drive occasions without encoder PG. Under this control mode, one inverter only drives one motor, such as machine tools, centrifuges, wire drawing machine etc.

1: V/F control

Applying for occasions which ask for normal performance of speed control accuracy and torque output at low frequency, such as fan or pump loads, one inverter can drive for one more motors.

Note:

- When SVC mode is selected, it needs motor parameters auto tuning (self-learning) before first running, to obtain accurate motor parameters. Once the self-learning process is complete, the parameters will be stored in the internal control board for later use. Paying particular attention to that before self-learning you must ensure that data on the nameplate data of motor must be accordant with motor parameters of inverter, otherwise it will lead to self-learning process not be completed or getting the wrong results. If failing in getting motor nameplate data, V / F control is better choice.
- When selection of vector control mode, it is necessary to properly set up the relevant parameters of speed regulator (refer to P1.14, P1.15), in order to assure good steady and dynamic performance.
- Under vector control mode, a frequency inverter can only drive one motor, moreover the difference between grading capacity of inverter and motor can not be too large, or it can lead to the control performance drop or not working properly of inverter.

P0.01	Frequency input channel selection	Factory setting	0
Setting range	0	Panel potentiometer setting	
	1	Keypad setting by  or digital encoder	
	2	UP/DOWN terminal digit setting	
	3	Communication setting	
	4	All analog voltage signal setting (0~10V)	
	5	All analog current signal setting (0~20mA)	
	6	Terminal pulse (0~20kHz)	
	7	Compounding setting	
	8	External terminal selection	



0: Keypad potentiometer

Through the operation of potentiometer on the keypad to adjust running frequency

1: Digital setting 1

Operating frequency is set by parameter P0.03, which also can be changed by operating the keypad  key or digital encoder in the course of running, the revised frequency value will be stored into P0.03 when in power-down. If the frequency does not need storage, you can directly set parameters P0.02 in order to change frequency.

Note:

LCD keyboard does not provide analog potentiometer, but a digital encoder, which can completely replace the  and  button and their functions to achieve digital frequency adjustment and function parameters amendment, as well as data storage, making operation easy to the customer. So we particularly declare that when use of the encoder, P0.01 should be set to "1" (digital setting 1) rather than "0", otherwise the digital encoder for frequency setting will invalid. If the customers need to use analog potentiometer to achieve a given frequency, please choose LED keypad or external potentiometer.

2: Digital setting 2

Operating frequency by external terminals defined as UP/DOWN function. When UP-COM is closed, frequency rises; when DOWN-COM is closed, frequency decrease; UP/DOWN with COM are closed or opened at the same time, frequency keeps at the

same. The revised frequency value will be stored into P0.03. Function of UP/DOWN terminal changing running frequency speed is set by parameter PA.05.

3: Digital setting 3

Operating frequency set by frequency commands which are received by RS485 communication port from PC.

4: AI1 analog voltage setting (0~10V)

Operating frequency set by external terminal AI1 (0~10V) , details referred to P5.00-P5.01.

5: AI2 analog current setting (0~20mA)

Operating frequency set by external terminal AI2(0~20mA/0~10V) , details referred to P5.02-P5.03

6: Pulse signal setting (0~20kHz)

Operating frequency set by pulse signal from external terminal DI6 (0~20kHz) , details referred to P5.04-P5.05.

7: Compounding setting

Operating frequency set by linearity combination of each setting channel, compounding mode decided on P5.15-P5.16.

8: External terminal selection

Through 8 kinds of on-off combinations of external multi-function terminals to confirm the frequency input channel. (0 means disconnection of multi-function terminal and terminal COM, 1 shows multi-function terminal connected with terminal COM). The function terminals are defined by P4.00-P4.05.

The combinations corresponding to the channels as following:

Channel terminal 3	Channel terminal 2	Channel terminal 1	Frequency setting channel
0	0	0	Keypad potentiometer
0	0	1	Digital setting 1
0	1	0	Digital setting 2
0	1	1	Digital setting 3
1	0	0	AI1 analog signal setting

1	0	1	AI2 analog signal setting
1	1	0	Terminal pulse setting
1	1	1	Compounding setting

Table 6-1

Note:

This feature is very useful for the occasions asking for real-time switching to frequency channel. If there not only requires voltage setting, but also current setting, the dynamic switching can be realized through compounding of multi-functional terminal "100" and "101". Of course, it can also be achieved directly through the definition of "frequency switching to AI2" multi-functional terminal.

P0.02	Digit frequency setting	Factory setting	00
	Setting range	00-11	

LED single digit

0: When the inverter is power off, setting frequency will be stored into Parameter P0.03, when power on, the value will resume automatically.

1: When inverter is power off, original setting value of frequency will lose, when power on, inverter will run from 0.0Hz.

LED tens digit

0: Stop setting frequency holds on.

1: Setting frequency will renew to P0.03 when inverter stops.

Note:

LED single digit setting only available when P0.01=1、2、3.

LED tens digit setting only available when P0.01=2、3. When P0.01=1 (Digital setting 1), always default as holding of setting frequency at stop.

P0.03	Operating frequency digit setting	Factory setting	0
	Setting range	0.00-Upper limit frequency	

When frequency setting channel is defined as digit setting(P0.01=1、2、3), the Initial operating frequency is determined by this parameter. When operation keypad is under monitoring mode, if set P0.01=1, then pressing ▲/▼ key can change the parameter directly; If set P0.01=2, the inverter will first speed up to initial frequency, second its output frequency increases or decrease based on the close or open status of UP/DOWN terminal.

P0.04	Running command selection		Factory setting	0
	Setting range	0	Operation command of the digital keypad	
		1	Operation command of the external terminal	
		2	Operation command of Communication interface	

This parameter define inverter physical channel which receive the command of operation ,stop,etc.

0: Operation command by the digital keypad

Operation by keys such as **RUN**, **STOP/RESET**, **REV/JOG** etc. on the keypad to control the running command. Under this mode, external terminal FWD status will influence the output phase sequence of inverter. When terminal FWD and COM are connected together, the output phase sequence will reverse to the original setting; On the contrary, when FWD and COM are disconnected.

1: Operation determined by the external terminal

Inverter running command is controlled by the on-off status of external terminal FWD, REV and COM, of which control methods are determined by P4.06. Factory setting as below:

Command	Terminal Status
Stop	FWD, REV and COM disconnection at the same time
Forward	FWD and COM close, REV and COM open
Reverse	REV and COM close, FWD and COM open

Table 6-2

2: Operated by PC through Communication interface

P0.05	Run direction setting		Factory setting	0
	Setting range	0	Forward	
		1	Reverse	
		2	Reverse forbidden	

By changing this function code, it can change the rotation direction of motor. This function is equivalent to the change in the direction of rotation through adjusting any two output lines of motor.

Note:

If this parameter has been set, when initializing the system parameter, the motor rotation direction will be restored to the original state. It shall be carefully used for the occasion that doesn't allow changing the motor rotation direction!

P0.06	Upper limit frequency	Factory setting	50.00Hz
	Setting range	[F0.07]—400.0Hz	
P0.07	Lower limit frequency	Factory setting	0.00Hz
	Setting range	0.00Hz—[F0.06]	

Upper limit frequency is maximum output frequency of inverter, shown as f_u , setting range is from [P0.07] to 400.0Hz; Lower limit frequency is minimum output frequency of inverter, shown as f_l , setting range is from 0.00Hz to [P0.06]; Inverter starts to run from its basic frequency. If the frequency gave is less than lower f_l , the inverter will run on f_l until inverter stop or the frequency value gave more than f_l .

P0.08	Basic running frequency	Factory setting	50.00Hz
	Setting range	1.00-Upper limit frequency (f_u)	

Basic running frequency, shown as f_b , is the corresponding min. frequency at Max. voltage output of inverter, which is usually rated frequency of motor and the base to set frequency and acceleration or deceleration time.

Note: it can not be adjusted randomly.

P0.09	Max. Output voltage	Factory setting	380V/220V
	Setting range	200V—500V/100V—250V	

Max. output voltage correspond to the maximum output voltage when inverter output basic operation frequency, it is usually motor rated voltage. If under V/F control mode, adjustment of this parameter can change the output voltage value of inverter; it is invalid if under SVC mode.

P0.10	Model selection	Factory setting	0
	Setting range	0	M type
		1	FP type

0: M type

Suitable for constant torque loads.

1: FP type

Suitable for fan, pump loads, of which output torque and speed are into a relation of parabola. When inverter is applied for this kind load, power of the inverter can be increase a level grade.

Note: Please do not change this parameter optionally, or it will lead to incorrect display of current and abnormal operation.

P0.11	Torque rising selection	Factory setting	0
	Setting range	0	Manual
		1	Automatic

It is mainly used to improve the motor torque characteristics at low frequency when the inverter is under V / F control mode, when the inverter is under vector control mode, this feature is invalid.

0: Manual

Torque rising voltage is specified by P0.12.

1: Automatic

Torque rising voltage is direct proportion to the variation of stator current. When torque rising selection is “1”, it can effectively prevent motor which is under light load from magnetism saturation due to excessive voltage increase, thereby

avoiding overheating of the motor at low frequency running. Formula to automatically torque rising as below for reference:

$$\text{Voltage increasing} = (P0.12/200) \times P0.09 \times (\text{Inverter output current}/\text{rated current})$$

Calculation of manually torsion rising voltage is similar to the above, except deleting the item “Inverter output current/rated current”, i.e. the proportion of inverter output current and rated current. Choosing the torsion quantity shall be based on the loads, improving torsion rising for bigger load, but rising extent shall not be excessive, or it will lead to the motor over excitation running, efficiency falling and easy overheating.

P0.12	Torsion rising setting	Factory setting	
	Setting range	0—30%	

It compensates the output voltage of inverter which is under low frequency running, figure showing as below:

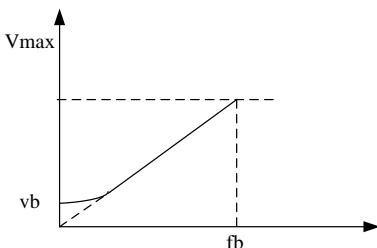

Diagram 6-1 Torque rising setting

P0.13	Rotation deviation frequency compensation	Factory setting	0.0%
	Setting range	0.0—150.0%	

Variation of loads sometimes can influence on the real rotation deviation of motor. Through this function setting, the inverter will automatically adjust the frequency output according to the loads situation. For example, running on 50Hz with rated current, the motor rev. must be less than synchronous rev. of running at 50Hz. Here it can improve motor rev. by setting this parameter.

Note: Only when P0.00=1, this parameter is available.

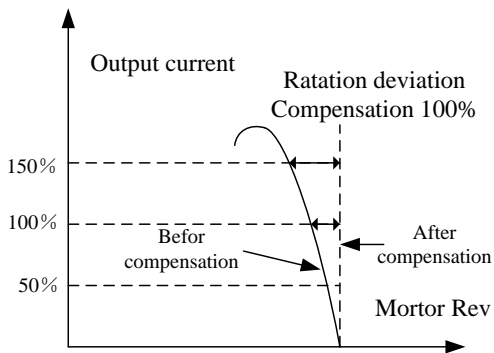

Diagram 6-2 Rotation deviation frequency compensation

P0.14	Acceleration time 1	Determined by inverter type
P0.15	Deceleration time 1	
	Setting range	0.1—3600s

Acceleration time is the time when inverter frequency output increases from 0Hz to basic frequency, shown in Diagram 6-3 as t1; Deceleration time is the time when inverter frequency output decreases from basic frequency to 0Hz, shown in Diagram 6-3 as t2.

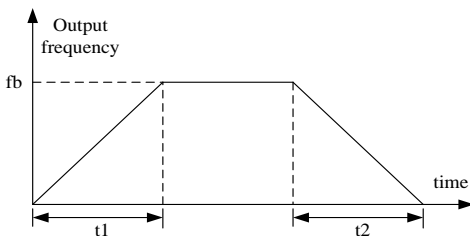

Diagram6-3Accel. & Decel. Time setting

There are four groups of Accel. & Decel., the others(2,3,4) are defined by P2.22-P2.27, which factory setting are P0.14、 P0.15. If other groups needed, please choose by control terminals.

P0.16	V/F curve setting	Factory setting	0
	Setting range	0-3	

0: Constant torque curve

Suitable for normal constant torque loads, of which voltage output is linearity to frequency output.

1: Decreasing torsion curve 1

Output 1.7 hypo-power decline torsion curves.

2: Decreasing torsion curve 2

Output 2.0 hypo-power decline torsion curves.

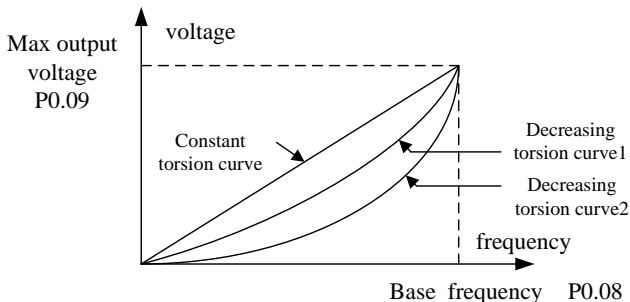

Diagram 6-4 V/F curve

Curve 1 and 2 are suitable for variable loads such as fan, pump and so on. Curve2 is better in energy saving than Curve 1. However, it will be unstable for the motor being out of excitation status under running at Curve 1 and 2. The curve choice or setting must base on specific conditions. Of course,the user can also adopt user-defined V/F curve.

3: User-defined V/F curve

Requisite V/F curve can be set through P0.17—P0.22, shown as Diagram 6-5.

Note: Only when P0.00=1, this group parameter is available.

P0.17	V/F Frequency F1	Factory setting	12.50Hz
	Setting range	0.00—Frequency F2	
P0.18	V/F Voltage V1	Factory setting	25.0%
	Setting range	0.0—Voltage V2	
P0.19	V/F Frequency F2	Factory setting	25.00Hz
	Setting range	Frequency F1—Frequency F3	
P0.20	V/F Voltage V2	Factory setting	50.0%
	Setting range	Voltage V1—Voltage V3	
P0.21	V/F Frequency F3	Factory setting	37.50Hz
	Setting range	Frequency F2—Basic operating frequency	
P0.22	V/F Voltage V2	Factory setting	75.0%
	Setting range	Voltage V2—100.0%	

This parameters group is used to expediently set requisite V/F curves.

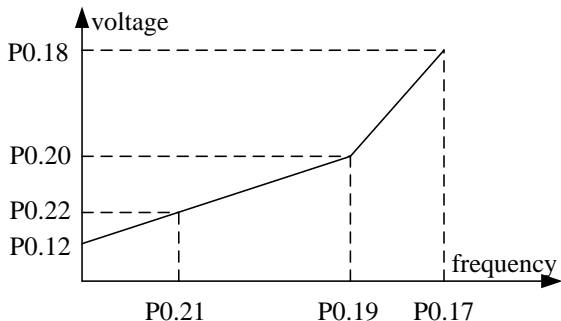

Diagram 6-5 V/F user-defined curve setting

P0.23	REV/JOG function selection	Factory setting	1
	Setting range	0	REV
		1	JOG

Function of key **REV/JOG** on operating keypad can be set by this parameter, which detailed setting as following:

0: This key is for REV running.

1: This key is for JOG running.

6.2 Motor and vector control parameter

P1.00	Motor rated voltage	Factory setting	380V/220V
	Setting range	200V—500V/100V—250V	
P1.01	Motor rated current	Factory setting	Determined by inverter type
	Setting range	0.1—600.0A	
P1.02	Motor rated rotation speed	Factory setting	Determined by inverter type
	Setting range	300—3000RPM	
P1.03	Motor rated frequency	Factory setting	50.00Hz
	Setting range	1.00—400.00Hz	
P1.04	Motor no-loading current	Factory setting	0.1A
	Setting range	0.1—500.0A	

The above parameters are for electric parameters of motor droved. If the power of motor is different from the inverter, the difference must keep within two-level grade, and the value of P1.01 must be same as the rated current of motor in order to ensure correct parameters checkout of motor when in motor auto tuning.

P1.05	Motor stator resistance	Factory setting	Determined by inverter type
	Setting range	0.001—10.000Ω	
P1.06	Motor rotor resistance	Factory setting	Determined by inverter type
	Setting range	0.001—10.000Ω	
P1.07	Inductance of stator and rotor	Factory setting	Determined by inverter type

	Setting range	0.01—600.00mH		
P1.08	Mutual inductance of stator and rotor	Factory setting	Determined by inverter type	
	Setting range	0.01—600.00mH		
P1.09	Reserved			

The above parameters which are necessary for vector control mode are used for setting basic electric parameters of motor.

These group parameters are fit for standard 4-pole motor which is factory setting, but not completely same. In order to achieve good controlling effect, motor parameters auto tuning is suggested. After auto tuning finishing, parameters of P1.05 to P1.08 will be renewed

Note: If you want to do parameters self-learning, please make sure correct input of motor parameters on the nameplate. If the capacity of inverter can not match with the motor's, which runs directly under vector control mode, it may cause damage or invalidity of inverter in controlling.

P1.10	Rotation deviation compensation factor	Factory setting	1.00
	Setting range	0.50—2.00	

For sensorless vector control mode, this parameter is used for adjusting the accuracy of steady-speed. When the motor drives heavy load, this parameter should be increased; on the other side, it should be decreased.

P1.11	Pre-excitation of motor selection	Factory setting	0
	Setting range	0	Conditionally available
		1	Available all long

In order to achieve enough starting torque when motor stay in stop stage before starting up, gap flux shall be built up.

0: Conditionally available

If this item is selected, the motor will do pre-excitation before startup, until the time

defined by P1.12, and then accelerate. Or the motor is controlled by the multi-functional terminals defined as pre-excitation command to produce with operation (provisional reservation).

1: Available all long

Execute pre-excitation to the motor when inverter starts to run. (Continued in 0.00Hz)

P1.12	Pre-excitation continuing time	Factory setting	0.2
	Setting range	0.1~10.0S	

This parameter specify the duration of motor pre-excitation under vector control mode.

During motor pre-excitation, the motor is under analogous DC brake status. So in this situation, DC brake function parameters are invalid. By adjusting the pre-excitation function and the continuing time, it can also achieve good effect of DC brake,

P1.13	Motor auto tuning	Factory setting	0
	Setting range	0	No action
		1	Static tuning

0: No action

1: Static tuning

If this function is selected, Press **RUN** key on the keypad to execute the motor auto-tuning operation. This process is accomplished by the system automatically, without human intervention. During this process, the other commands can not be responded. After the auto tuning procedure is complete, P1.13 will be cleared to zero. The parameters achieved will be stored into the inverter, namely parameter P1.05, P1.06, P1.07 and P1.08 have been updated.

Note: This parameter is only valid under vector control mode (P0.00=0) and keypad control mode (P0.04=0).

If over-current fault occur in the process of motor auto-tuning, please check whether the motor current is match with the rated current of inverter. Make sure that the inverter is in stop status before proceeding with the auto tuning, or else auto tuning will be not done. The advantage of static tuning is to determine motor parameter under the situation of motor shaft don't leave load.

P1.14	ASR proportion (P) gain	Factory setting	1.00
	Setting range	0.01~5.00	
P1.15	ASR integration (I) time constant	Factory setting	2.00S
	Setting range	0.01~10.00S	

Parameter P1.14, P1.15 are only valid to vector control mode. It is invalid for v/f control.

Increasing proportion gain can quicken dynamic response of system, but excessive increase will lead to easy vibration; decreasing integral time constant can quicken dynamic response either, be careful not to minish too much, since a rapid response may cause oscillation to the system. Generally, under the precondition of stable system, try to augment the proportion gain first, and then adjust the integration time constant, in order to make the system have quick response and not over tune.

6.3 Auxiliary parameter

P2.00	Starting mode	Factory setting	0
	Setting range	0	Star with starting frequency
		1	Speed tracking start
P2.01	Starting frequency	Factory setting	0.00Hz
	Setting range	0.00—10.00Hz	
P2.02	Starting frequency duration	Factory setting	0.0s
	Setting range	0.0~10.0s	

0: Star with starting frequency

The most loads start up though conventional ways which refer to the setting of P2.01 and P2.02. For the applications desiring for high starting torque, starting frequency can effectively meet for the requirement. Starting frequency duration is the time for the inverter running on starting frequency. When it is set to 0, it will be invalid and the motor will start to run from 0Hz. For starting with DC brake, please refer to setting of P2.03, P2.04.

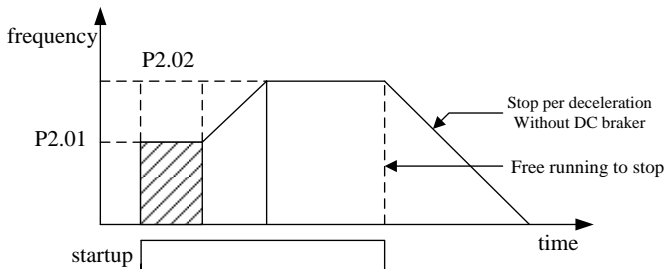

Diagram 6-6 Start and stop frequency output curve

1: Speed tracking start

When inverter runs, it check the rotation speed and direction of motor, then trucking current speed and direction of motor basing on the check result, smoothly starting the motor if it is in rotation.

Note: The inverter can't drive the motor of which power is bigger than itself when using this startup way, or else it will easily cause over current protection. When the system inertia is big, please properly increase the acceleration or deceleration time.

P2.03	DC braking current level at starting	Factory setting	0.0%
	Setting range	0—100.0%	
P2.04	DC braking time at starting	Factory setting	0.0s
	Setting range	0.0—30.0s	

DC braking current level at starting: Brake current percent when the inverter starts according to DC brake.

DC braking time at starting: DC brake current output duration during the inverter starts.

When DC braking time is 0, the function is invalid; when P2.03, P2.04 are set, the motor will execute DC brake function first, second start from starting frequency lasting for the time defined by P2.02, and then accelerate to requested frequency.

Note: Only when P0.00=1, this group parameters are valid.

P2.05	Accel.&Decel. way	Factory setting	0
	Setting range	0	Beeline
		1	S-curve

0: Beeline acceleration

The inverter frequency output vary by fixed speed, which is linear relationship with accel & decel time. The most of loads use this way.

1: S-curve acceleration or deceleration

During accelerating or decelerating, the inverter frequency output is S-curve relationship with accel & decel. time, shown as Diagram 6-7. This function is for reducing noise and load concussion during accelerating and decelerating process. Parameter for S-curve is determined by P2.06 and P2.07.

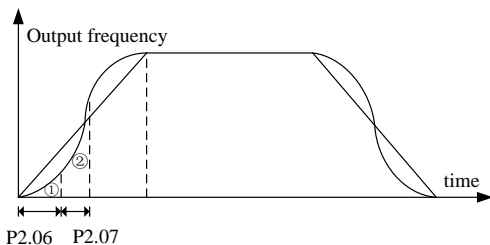

Diagram 6-7 S-curve accel. & decel.

P2.06	S-curve starting duration proportion	Factory setting	20.0%
	Setting range	10.0—40.0%	
P2.07	S-curve ascend/descend duration proportion	Factory setting	60.0%
	Setting range	10.0—40.0%	

S-curve starting stage, shown as ① in Diagram 6-7, is the process that slope of frequency output gradually increases from zero; S-curve ascending stage, shown as ② in Diagram 6-7, is the process that slope of frequency output keeps invariable. It specially apply for transmission and carrier loads with combination use of above parameter

P2.08	AVR function	Factory setting	1
	Setting range	0	Inhibitive
		1	Allowable

0: Inhibitive**1: Allowable**

AVR means automatic voltage adjustment, when there is deviation between voltage input and rated value of the inverter, it can through this function to ensure stable voltage output of the inverter, however it will be invalid if the value of voltage output bigger than input voltage of power supply. During decelerating, if no action of AVR, the deceleration time is short and running current is big; if action of AVR, motor deceleration is placid and running current is small, but the deceleration time will be long.

P2.09	Automatic energy-saving operation	Factory setting	0
	Setting range	0	Inhibitive
		1	Allowable

0: Inhibitive**1: Allowable**

If the inverter is under automatic energy-saving operation, it will automatically check the load situation and adjust voltage output in order to make the motor in high effect energy saving status.

The energy saving effect is much evident if the load's variation frequency is low and scope is large. The work principle is that adjusting motor excitation state make the motor work in a state of optimal efficiency under the light loads, and maximum limit reduces the energy consumption of the motor and gain additional energy saving effect.

Note: This function is mainly fit for loads of fan and pump.

P2.10	Forward and reverser rotation dead-zone interval		Factory setting	0.0s
	Setting range	0.1—10.0s		

When the inverter receives Reverser rotation command when inverter is running, it will run from the present direction to the opposite. The interval is the waiting transition time when the inverter outputs zero frequency during the above process, shown as t_1 in Diagram 6-8.

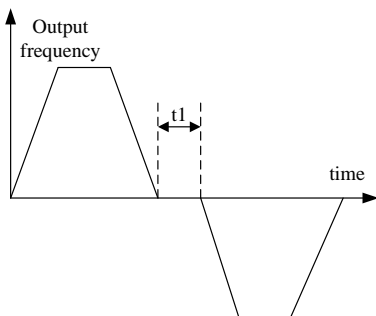

Diagram 6-8 forward and reverser rotation dead-zone interval

P2.11	Stop mode		Factory setting	0
	Setting range	0	Ramp to stop	
		1	Coast to stop	

0: Ramp to stop

The inverter frequency output decelerates in the time specified by P0.15, down to zero and then the inverter turns off.

If the DC brake function is selected for stop, when the output frequency decrease down to DC brake starting frequency, the inverter will start DC brake until completely stopping output.

1: Coast to stop

When the inverter receives stop command, it stops output immediately and the motor will run freely to stop. In general ,when you choose this way to achieve stop quickly ,it need to match up external mechanical brake .

It is inhibitive to be used for pump loads, or it may lead to water hammer effect and rupture pipe. Please refer to setting of P2.12, P2.13, P2.14 for Ramp to stop with DC brake.

P2.12	Starting frequency for DC braking during STOP	Factory setting	Determined by inverter type
	Setting range	0.0—20.00Hz	
P2.13	DC braking current during STOP	Factory setting	Determined by inverter type
	Setting range	0.0—100.0%	
P2.14	DC braking time durng STOP	Factory setting	Determined by inverter type
	Setting range	0.0—30.0s	

The DC brake parameter is set by above parameter when stop

P2.12 is the frequency for starting DC brake during inverter deceleration stop;

P2.13 is the inveter output current when starting DC brake, relative to percentage of the rated output current;

P2.14 is the duration of DC brake during stop.If P2.14=0, DC brake is invalid.

P2.15	Power-off restart setting	Factory setting	0
	Setting range	0	Inhibitive
		1	Normal start
		2	Speed trucking start
P2.16	Restar waiting time after power-off	Factory setting	0.5s
	Setting range	0.0—20.0s	

Note: It is only valid for terminal 2 line type control.

P2.15=0, the inverter will not automatically start to run at power-on after power-off

P2.15=1, When power comes after power loses, the inverter will start from starting frequency after the time defined by P2.16;

P2.15=2, When power comes after power loses, the inverter will start from trucking speed after the time defined by P2.16;

During the waiting time, any command input is invalid. If stop command is input, the inverter will release from speed trucking start status to normal stop status.

Note: It must be much careful to set this parameter, or it may take hurt to equipment or personnel because of unexpected startup of motor.

P2.17	Failure self-reset times	Factory setting	0
	Setting range	0-10	
P2.18	Failure self-reset interval	Factory setting	3.0s
	Setting range	0.5-25.0s	

During running, if the inverter is in fault, it will stop output and show out fault code.

After passing the time defined by P2.18, the inverter will self-reset from the failure and go on running. The times of failure self-reset is specified by P2.17, if which was set to 0, there is no self-reset function. Resetting the fault is only by hand pressing key

STOP/RESET.

The inverter do not allow to be self-reset to the failure of overheat of overload

P2.19	Jog running frequency	Factory setting	10.00Hz
	Setting range	0.00—50.00Hz	
P2.20	Jog accel. time	Determined by inverter type	
P2.21	Jog decel. time	Determined by inverter type	
	Setting range	0.1—3600s	

The above parameters specify the jog running parameters correlated, shown as the following Diagram 6-9:

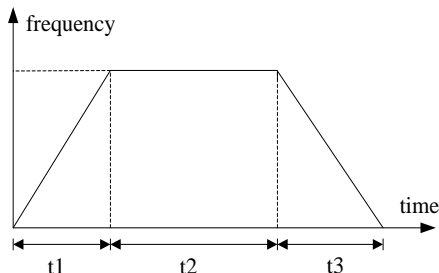

Diagram 6-9 Jog running parameters

t1: actual jog acceleration time;t3: actual jog deceleration time;

t2: Jog running time;f1: jog running frequency.

Note: P2.20, P2.21 is the accel.& decel time when jog frequency is equal to basic frequency (50Hz), however the factory setting of jog frequency is 10 Hz, so calculating according to this proportion, the actual accel. & decel. time shall be set as 20% of factory setting value. In addition, the jog running command can be realized by keypad, external terminals or PC input.

P2.22	Accel. time 2	Determined by inverter type
P2.23	Decel. time 2	Determined by inverter type
P2.24	Accel. time 3	Determined by inverter type
P2.25	Decel. time 3	Determined by inverter type
P2.26	Accel. time 4	Determined by inverter type
P2.27	Decel. time 4	Determined by inverter type
	Setting range	0.1-3600s

Please refer to P3.09 for the setting of above parameters.

The above parameter set the accel and decel.time of 2,3,4 respectively.

Accel. & decel. time 1、 2、 3、 4 all can selected by control terminals,and as the accel and decel.time during inverter running. The function of terminals is determined by the choice of P4.00-P4.05.

P2.28	The 1st step freq.	Factory setting	5.00Hz
P2.29	The 2nd step freq.	Factory setting	10.00Hz
P2.30	The 3rd step freq.	Factory setting	15.00Hz
P2.31	The 4th step freq.	Factory setting	20.00Hz
P2.32	The 5th step freq.	Factory setting	25.00Hz
P2.33	The 6th step freq.	Factory setting	30.00Hz
P2.34	The 7th step freq.	Factory setting	40.00Hz
P2.35	Reserved		
	Setting range	0.00—Upper limit frequency	

They are used to define the frequency for multi-step speed running from step 1 to 7. Please refer to P7.00 for details.

P2.36	Skip freq. 1	Factory setting	0.00Hz
P2.38	Skip freq. 2	Factory setting	0.00Hz
P2.40	Skip freq. 3	Factory setting	0.00Hz
	Setting range	0.0—Upper limit frequency	
P2.37	Skip freq. band 1	Factory setting	0.00Hz
P2.39	Skip freq. band 2	Factory setting	0.00Hz
P2.41	Skip freq. band 3	Factory setting	0.00Hz
	Setting range	0.0—10.0Hz	

Setting of above parameters is mainly used for avoiding mechanical resonance due to the inverter running on the resonant frequency points. When the skip frequency is set, the inverter will skip from the frequency points set them during running. No matter accel and decel, speed, the frequency of inverter will pass these points. If the skip frequency range is set to 0, the corresponding resonant frequency point has no function of skip. The output frequency of inverter can perform skip operation at some frequency points, shown as Diagram 6-10.

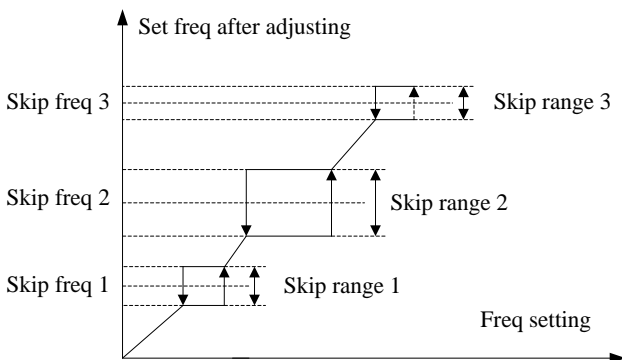

Diagram 6-10 Skip frequency action

P2.42	Carrier frequency selection	Determined by inverter type
	Setting range	1.0—12.0KHz

This parameter is used for setting carrier frequency of PWM wave by inverter output. Carrier frequency will affect the noise of the motor running. In the mute occasion, it is need to increase carrier frequency.

Increasing the setting value of carrier frequency can reduce the noise of motor, but also result in rise of inverter temperature, as well as augmentation of interference to the environment. Please adjust with caution

Running on the carrier frequency exceeding factory setting, inverter need to reduce 5% for per increasing 1 KHZ.

P2.43	Carrier control method	Factory setting	1
	Setting range	0	Fixed carrier
		1	Automatic adjustment

0: Fixed carrier

1: Automatic adjustment

When P2.43 is set to 1, the carrier is self-correcting according to frequency variation in order to improve torque feature at low frequency.

6.4 User managing interface parameter

P3.00	LCD language selection	Factory setting	0
	Setting range	0	Chinese
		1	English

0: Chinese**1: English (reserved)**

This parameter is used for setting language display on the operating keypad, which is only valid to LCD display keypad.

P3.01	Parameter initialization	Factory setting	0
	Setting range	0	Disabled
		1	Revert to factory setting
		2	Eliminate fault record

0: Disabled

Under this status, parameters of inverter can be read out and wrote in.

1: Revert to factory setting

Get all parameters from parameter group P0 to PA back to factory setting value.

Note: This parameter is invalid to parameter P0.00, P0.01, P0.04 and P0.10, which only can be manually modified; This parameter will eliminate the parameters obtaining from motor parameter auto tuning. If the vector control mode is selected, it need to auto tune again after parameter initialization.

2: Eliminate fault record

It will eliminate historical records of inverter.

P3.02	Parameter read-in protection	Factory setting	0
	Setting range	0	Allowed to modify all parameters
		1	Only allow to change the frequency
		2	Forbidden to modify all parameters

0: Allowed to modify all parameters

Note: Some of the parameters can not be changed during inverter running.

1: Only allow to change the frequency**2: Forbidden to modify all parameters**

This function can prevent others from arbitrarily modifying the parameters setting of inverter.

P3.03	Factory password	Factory setting	0
	Setting range	0—9999	
P3.04	Monitoring parameter 1 selection	Factory setting	0
	Setting range	0—18	
P3.05	Monitoring parameter 2 selection	Factory setting	1
	Setting range	0—18	

These parameters are used for display objects on the display panel, i.e. contents display on LED or LCD. Hereinto, LED displays monitoring parameter 1. LCD displays monitoring parameter 2 on its down left corner region.

P3.06	Linear velocity quotiety	Factory setting	1.00
	Setting range	0.01—100.0	

When the velocity display is linear velocity, the converting formula shows as below:
 Linear velocity = Frequency × Linear velocity quotiety

P3.07	Close loop display quotiety	Factory setting	1.00
	Setting range	0.01—100.0	

PID feedback value ÷ the setting value = Close loop display quotiety × Actual feedback value ÷ the setting value

P3.08	Software edition	Factory Setting
	Setting range	0—99.99

P3.09	Accel. & Decel. time unit	Factory setting	0
	Setting range	0	Second
		1	Minute

Default is second for the unit of setting accel.&decel.time

6.5 Digital input and output parameter

P4.00	Input terminal DI1 function	Factory setting	0
P4.01	Input terminal DI2 function	Factory setting	0
P4.02	Input terminal DI3 function	Factory setting	0
P4.03	Input terminal DI4 function	Factory setting	0
P4.04	Input terminal DI5 function	Factory setting	0
P4.05	Input terminal DI6 function	Factory setting	0
	Setting range	0—30(detail refers to the followings)	

0: Leave control terminal unused

1: Multi-step speed definition 1

2: Multi-step speed definition 2

3: Multi-step speed definition 3

ON/OFF combination of the input terminals with terminal COM for selection of multi-step speed output frequency, shown as Table 6-3:

Multi-step speed definition 3 terminal	Multi-step speed definition 2 terminal	Multi-step speed definition 1 terminal	Speed step available
OFF	OFF	OFF	No freq. variation
OFF	OFF	ON	1st
OFF	ON	OFF	2nd
OFF	ON	ON	3rd
ON	OFF	OFF	4th
ON	OFF	ON	5th
ON	ON	OFF	6th
ON	ON	ON	7th

Table 6-3

4: Accel. & Decel. 1**5: Accel. & Decel. 2**

There are 4 ways to achieve acceleration and deceleration time selection with ON/OFF combination, shown as Table 6-4:

Accel. & Decel 2	Accel. & Decel 1	Accel. & Decel time available
OFF	OFF	1
OFF	ON	2
ON	OFF	3
ON	ON	4

Table 6-4**6: Freq. channel selection 1****7: Freq. channel selection 2****8: Freq. channel selection 3**

When the frequency input channel is controlled by external terminal, namely P0.01=8, frequency setting channel are specified by status of the three terminals. Please refer to Table 6-1 for their corresponding relation.

9: Forward jog control

Operation of forward jog controlled by external terminals.

10: Reverse jog control

Operation of forward jog controlled by external terminals.

Forward jog gives priority to reverse jog. When they are closed at the same time, forward jog is in effect.

11: Free stop control

Used for stopping the inverter under external terminal control mode. When the terminal defined as this function with common terminal COM is closed, the inverter will stop. If they are open, it will start to run by speed tracking mode.

12: Freq. increasing command

Used for controlling frequency increasing.

13: Freq. decreasing command

Used for controlling frequency decreasing.

14: Peripheral failure input (constant open and effectual when closed)

Can by input the peripheral failure signal to enable inverter to perform fault monitoring against the exterior equipment.

15: Three-line operation control

When P0.04=1 and combination of running command terminals is three-line control, the terminals defined will become to stop trigger switch of the inverter. Detail is referred to parameter P4.06 explanation.

16: DC braking command

When inverter stop, if the terminals close defined by this parameter, DC braking function start up at the time output frequency is lower than start frequency of DC brake ,until the terminals brake up. Please refer to parameters P2.12-P2.14 for details.

17: Counter reset signal input

Working with the 18 item function to reset the counter built in the inverter.

18: Counter trigger signal input

Pulse input interface of counter built-in. Which frequency range is 0-500hz.

19: Exterior pulse input

The terminal receives exterior pulse as frequency given. Please refer to parameters P5.04 and P5.05 for correlated settings.

Note:

1. The 18, 19 items are only available to terminal DI6, i.e. terminal DI6 can be defined as these functions.
2. The max frequency of input pulse is 20 KHZ; low amplitude level is 0V, the high is 18~26V.

20: Exterior reset signal input (RESET)

When the inverter is in failure, it can clear the failures and resume the inverter to normal status, which function is equal to the function of key STOP/RESET.

21: UP/DOWN terminal frequency reset

When the frequency setting channel selection is available to terminal UP/DOWN control, it can clear the running frequency directly.

22: PID operation available

When the terminal is defined as this function under terminal control mode, it can make PID operation in effect.

23: Programmable multi-step speed running available

When the terminal is defined as this function under terminal control mode, it can make programmable multi-step speed running(PLC) in effect.

24: Wobbling frequency operation available selection

When the terminal is defined as this function under terminal control mode, it can make wobbling frequency operation in effect.

25: Wobbling freq. status reset

When the wobbling frequency function is selected, whether it is automatically or manually input by terminals, closure of the terminal defined as this function will remove memory-status information of wobbling frequency, which will restart if disconnection of the terminal.

26: Exterior stop command

This command is available to all running command channels. If this terminal function is available, the inverter will be stopped basing on mode defined by P2.11

27: Inverter running forbidden command

If this terminal function is available, the running frequency will stop freely and standby of inverter is forbidden to start. It main apply for security interaction occasion.

28: Inverter accel. & decel. forbidden command

If this terminal function is available, it can prevent the inverter from influence by extra signals except stop command, and keep same running speed to the inverter.

29: Commands input switched to terminal

If this terminal function is available, the channel of running command will be coercively switched to external terminal control; disconnection of the terminal, it will revert to original running command channel.

30: Freq. input channel switched to AI2

If this terminal function is available, the channel of frequency setting will be coercively switched to AI2 input; disconnection of the terminal, it will revert to original frequency setting channel.

31.Power-on by alarm

Terminal is valid,namely the timer timing starts

32.Zero clearing by alarm

Terminal is valid ,namely it will be cleared zero when the timer timing starts

P4.06	FWD/REV terminal control method	Factory setting	0
	Setting range	0	Two-line control mode 1
		1	Two-line control mode 2
		2	Three-line control mode 1
		3	Three-line control mode 2(Reserved)

0: Two-line control mode 1

Shown as Diagram 6-11 (Default mode):

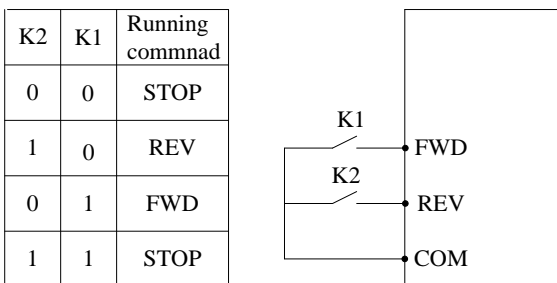
**Diagram 6-11 Two-line control mode 1****1: Two-line control mode 2**

Shown as Diagram 6-12:

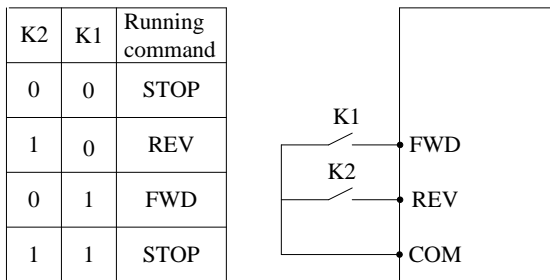
**Diagram 6-12 Two-line control mode 2****2: Three-line control mode 1**

Shown as Diagram 6-13, thereinto DI1 is the terminal for three-line operation control,

selected from any one of input terminals DI1 ~ DI6.

SB2—Switch for forward running (constant open)

SB1—Switch for stopping (constant closed)

SB3—Switch for reward running (constant open)

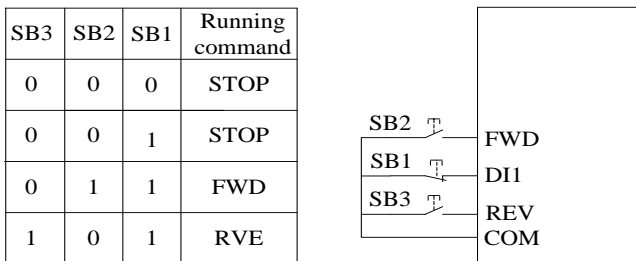

Diagram 6-13 Three-line control mode 1

3: Three-line control mode 2

Shown as Diagram 6-14, thereinto DI1 the terminal for three-line operation control, selected from any one of input terminals DI1 ~ DI6.

SB2—Switch for forward running (constant open)

SB1—Switch for stopping (constant closed)

K—Direction switch

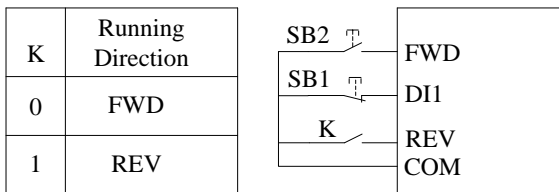

Diagram 6-14 Three-line control mode 2

P4.07	Open collector terminal DO1 output	Factory setting	0
P4.08	Open collector terminal DO2 output	Factory setting	1
P4.09	Programmable relay output	Factory setting	15
	Setting range	0—15(refer to following explanation)	

0: Inverter running indication

When the inverter is running, it has effective signal output, or it will output ineffective signal.

1: Frequency/speed arrival signal (FAR)

Please refer to P4.12 explanation for details.

2: Frequency/speed level detecting signal (FDT)

Please refer to P4.10 explanation for details.

3: Inverter zero speed running indication

Refers to inverter output frequency is 0.00HZ, but it is still be output indication signal in the running stage at the moment.

4: Peripheral failure stop

During the inverter running, when digital (on-off quantity) input terminal receives peripheral failure stop signal which results in failure stop, the inverter sends out indication signal.

5: Output freq. arriving at the upper limit

Indication signal output of the inverter reaching the upper limit frequency.

6: Output freq. arriving at the lower limit

Indication signal output of the inverter reaching the lower limit frequency.

7: Programmable multi-step speed circular running finished

Indication signal output is from this terminal when one cycle of programmable multi-step speed(PLC) circulation finish (Single pulse, signal width 500mS).

8: Inverter overload alarming signal

When the current output exceeds the overload alarming level, after the time delay set, it sends out indication signal.

9: Inverter start to run in train

It means that the inverter is without failure, bus voltage is normal; inverter forbidden operation terminal is invalid. It can start to run and then sends out indication signal.

10: Counter checkout signal output

Please refer to Parameter P4.16 explanation.

11: Counter reset signal output

Please refer to Parameter P4.15 explanation.

12: Inverter failure

When the inverter stops running due to failure, the terminal send out effective signal, low level voltage. In normal it is under high resistance status.

13: Less voltage stopping

When the bus voltage is less then the minimum value allowed, it sends out indication

signal and the LED displays “POFF”.

14: Wobbling frequency fluctuation limit

After choice of wobbling frequency function, if the frequency fluctuating range reckoned out by center frequency exceeds the upper limit frequency P0.06 or under the lower limit frequency P0.07, it sends out indication signal.

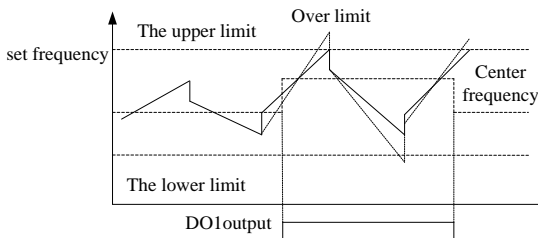

Table 6-15 Wobbling frequency fluctuation limit

15: Programmable multi-step speed running finished

It sends out an effective signal after one stage of Programmable multi-step speed running finished, of which width is 500mS.

16: Reserve

17: Timing to reach output

One pulse signal of 500mS width will be output when timing cumulative reach PA.07 setting.

Note: Terminal DO1, DO2 effective signals are of low voltage, asking for 24VDC power supply connected with resistor; The relay output is digital (on-off) signal.

P4.10	FDT level setting	Factory setting	0.00Hz
	Setting range	0.00Hz—upper limit frequency	
P4.11	FDT lag value	Factory setting	1.00Hz
	Setting range	0.00Hz—30.00Hz	

These parameters are used for setting frequency checkout level. When frequency output rise exceeds FDT level setting, inverter has open-loop collector output; when the frequency output decrease to the value less FDT lag value, inverter has high resistance status output, shown as Diagram 6-16:

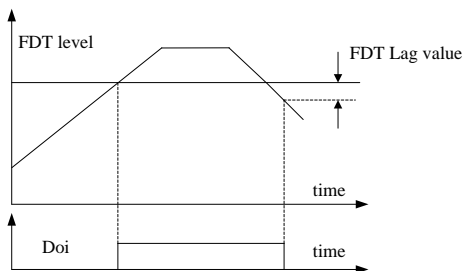

Diagram 6-16 FDT setting

P4.12	Freq. arrival FAR checkout width	Factory setting	0.00Hz
	Setting range	0.00—15.00Hz	

When output frequency of inverter is in the range of positive/negative checkout of setting frequency, the selected output terminals will output open collector signal, shown as Diagram 6-17:

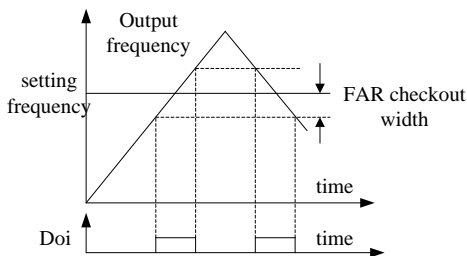

Diagram 6-17 FAR Frequency arrival signal output

P4.13	Overload pre-alarm checkout level	Factory setting	100%
	Setting range	20—120%	
P4.14	Overload pre-alarm delayed time	Factory setting	1.0S
	Setting range	0.0~15.0s	

Overload pre-alarm checkout level defines the current threshold of overload pre-alarm operation. Its setting range is corresponding to percentage of rated current, which shall be less than motor relaying protection factor usually.

When the output current is equal to overload pre-alarm level, and the time of output current exceeds the setting time of overload pre-alarm operation, the overload pre-alarm operation will act.

P4.15	Counter reset value	Factory setting	1
	Setting range	0—9999	
P4.16	Counter checkout value	Factory setting	1
	Setting range	0—F4.15	

The function of counter is defined by this parameters, the clock terminal of counter input from external terminal X6.

When the counting value of counter to exterior clock reach the value set by P4.15, the multi-function terminal concerned will send out signal, which is equal to exterior effective signal period, and reset the counter;

When the counting value reach the value set by P4.16, the multi-function terminal concerned will send out effective signal. If counting keeps on and the value exceeds the value set by P4.15, the signal will be canceled at the resetting to the counter.

Shown as following diagram, DO1 is defined as reset signal output, DO2 is defined as checkout signal output, P4.15 is set to “8”, and P4.16 is set to “5”.

When the checkout value is equal to “5”, DO2 will send out collector open signal and keep on; when the reset value is equal to “8”, DO1 will send out collector open signal and reset the counter, at the same time DO1, DO2 will cancel signal output.

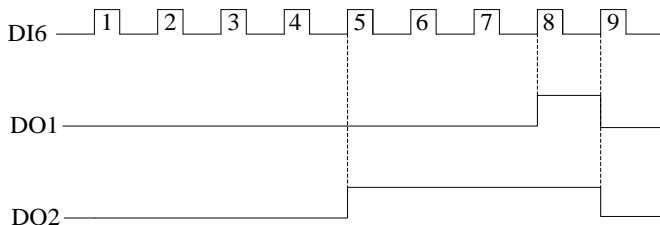

Diagram 6-18 Counter rest value and counter checkout value setting

6.6 Analog input and output parameter

P5.00	AI1 input voltage of lower limit	Factory setting	0.0V
	Setting range	0.0—F5.01	
P5.01	AI1 input voltage of upper limit	Factory setting	10.0V
	Setting range	P5.00—10.0V	

The above parameters define the range of analog voltage input channel AI1, which shall be set according to actual input signal.

P5.02	AI2 input current of lower limit	Factory setting	0.0mA
	Setting range	0.0—P5.03	
P5.03	AI2 input current of upper limit	Factory setting	20.0mA
	Setting range	P5.02—20.0mA	

The above parameters define the range of analog voltage input channel AI2, which shall be set according to actual input signal.

Note:

Usually AI2 is used for current signal input, if special need, it also can be used for voltage signal input by choosing jumper terminal JP1. The mathematical relationship between can refer to $20\text{mA}=10.0\text{V}$

P5.04	Pulse input frequency of lower limit	Factory setting	0.0kHz
	Setting range	0.0—P5.05	
P5.05	Pulse input frequency of upper limit	Factory setting	10.0kHz
	Setting range	P5.04—20.0KHz	

The above parameters define the frequency range of exterior pulse.

P5.06	Setting frequency to minimum input	Factory setting	0.00Hz
	Setting range	0.0Hz—upper limit frequency	
P5.07	Setting frequency to maximum input	Factory setting	50.00Hz
	Setting range	0.0Hz—upper limit frequency	

The above parameters are used for setting the corresponding relation between external analog input quantities and setting frequency, the relationship between frequency set signal after dealing with filter and gain with setting frequency shown as Diagram 6-19; both voltage signal and current analog can realize positive or negative action characteristics individually. Note: Fmax and Fmin separately correspond to the max analog input frequency and min analog input frequency.

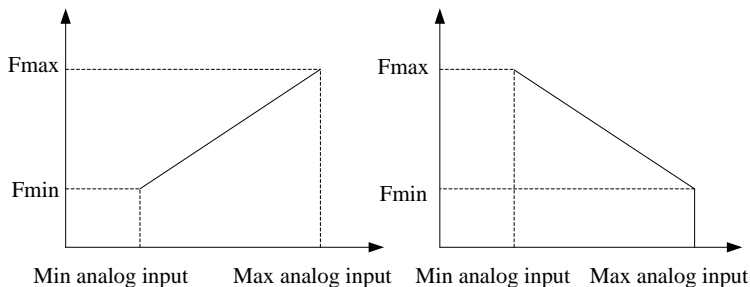

Diagram 6-19 The max & min analog input corresponding setting frequency

P5.08	Delayed time to analog input signal	Factory setting	0.5s
	Setting range	0.1—5.0s	

This parameter is used for filtering analog signal input by terminal AI1, AI2 and potentiometer on the keypad basing on the setting delayed time, in order to remove effect by interference signal. If the time set is too long, it will reduce responding speed of given signal.

P5.09	AO1 multi-functional analog output terminal function selection	Factory setting	0
	P5.10	DO3 multi-functional pulse output terminal function selection	Factory setting
Setting range	0	Output frequency	
	1	Setting frequency	
	2	Output frequency	
	3	Motor rev.	
	4	Output voltage	
	5	Bus voltage	
	6	PID ration	
	7	PID feedback	

AO1 is multi-function analog output terminal; DO3 is multi-function pulse output terminal. Their function setting as below:

0: Output frequency

Analog output width or pulse output frequency is positively proportional to inverter output frequency.

AO1: (0-AO1 upper limit) ~ (0.00-upper limit frequency)

DO3: (0-DO3 upper limit) ~ (0.00-upper limit frequency)

1: Setting frequency

Analog output width or pulse output frequency is positively proportional to inverter setting frequency.

AO1: (0- AO1 upper limit) ~ (0.00-setting frequency)

DO3: (0-DO3 upper limit) ~ (0.00-setting frequency)

2: Output current

Analog output width or pulse output frequency is positively proportional to inverter output current.

AO1: (0- AO1 upper limit) ~ (0.0- twice rated current)

DO3: (0- DO3 upper limit) ~ (0.0-twice rated current)

3: Motor rev.

Analog output width or pulse output frequency is positively proportional to motor rev.

AO1: (0- AO1 upper limit) ~ (0- motor synchronous speed)

DO3: (0- DO3 upper limit) ~ (0- motor synchronous speed)

4: Output voltage

Analog output width or pulse output frequency is positively proportional to inverter output voltage.

AO1: (0- AO1 upper limit) ~ (0-maximum/rated output voltage)

DO3: (0- DO3 upper limit) ~ (0-maximum/rated output voltage)

5: Bus voltage

Analog output width or pulse output frequency is positively proportional to inverter bus voltage.

AO1: (0- AO1 upper limit) ~ (0-800V)

DO3: (0- DO3 upper limit) ~ (0-800V)

6: PID ration

Analog output width or pulse output frequency is positively proportional to PID ration.

AO1: (0- AO1 upper limit) ~ (0.00-10.00V)

DO3: (0- DO3 upper limit) ~ (0.00-10.00V)

7: PID feedback

Analog output width or pulse output frequency is positively proportional to PID feedback.

AO1: (0- AO1 upper limit) ~ (0.00-10.00V)

DO3: (0- DO3 upper limit) ~ (0.00-10.00V)

P5.11	AO1 gain setting	Factory setting	100%
	Setting range	20—200%	
P5.13	DO3 gain setting	Factory setting	100%
	Setting range	20—200%	
P5.12	Reserved		
P5.14	Reserved		

P5.11 defines the upper limit output of AO1. When the factory setting is 100%, the output voltage & current range is 0-10V & 0-20mA. The analog voltage or current output is decided by jumper terminal JP2.

AO1 output=(0-10V/0-20mA)×AO1 gain setting (not more than 10V/20 mA)

P5.13 defines the upper limit output of DO3. When the factory setting is 100%, the output frequency range is 0-10KHz.

DO3 output=(0-10 KHz)×DO3 gain setting (not more than 20 KHz)

P5.15	Compounding given channel setting	Factory setting	000
	Setting range	000—666	

LED single digit: Operand 1

- 0: Keypad potentiometer;
- 1: Digital setting 1
- 2: reserved
- 3: Communication setting
- 4: AI1
- 5: AI2
- 6: Terminal pulse

LED tens digit: Operand 2

- 0: Keyboard potentiometer
- 1: Digital setting 1
- 2: Reserved
- 3: Communication setting
- 4: AI1
- 5: AI2
- 6: Terminal pulse

LED Hundreds digit: Operand 3

- 0: Keyboard potentiometer
- 1: Digital setting 1
- 2: Reserved
- 3: Communication setting
- 4: AI1
- 5: AI2
- 6: Terminal pulse

LED Thousands digit: Reserved

P5.16	Combination given arithmetic setting	Factory setting	00
	Setting range	00—54	

LED single digit: Arithmetic 1

- 0: Addition
- 1: Subtraction
- 2: Absolute value (subtraction)
- 3: Choose Maximum.
- 4: Choose Minimum.

LED tens digit: Arithmetic 2

- 0: Addition
- 1: Subtraction

- 2: Absolute value (Subtraction)
- 3: Choose Maximum.
- 4: Choose Minimum.
- 5: Operand 3 not be concerned with operation

LED Hundreds & thousands digit: Reserved

Note: only P0.01=7, parameter P5.15、 P5.16 are effective.

When P0.01=7, each analog and digital input quantity compounding arithmetic formula as below:

If P5.16 LED tens digit is set to “5”, operand 3 will not participate in the arithmetic, and only the other two operands 1 and 2 are in operation compounding.

For example first, if P5.15 is set to “531” and P5.16 is set to “10”, the operation compounding is equal to $\{(digital\ setting\ 1 + communication\ setting) - AI2\}$

For example second, if P5.15 is set to value “410” and P5.16 is set to “21”, the operation compounding is equal to $\{(keypad\ potentiometer - digital\ setting) - AI1\}$.

Note:

Algorithm 1: Under any circumstances, the operation process is operating operand 1 and operand 2 according to algorithm 1 to get result 1, then operating result 1 and operand 3 to get the final result. If operation result 1 of the former two operands is negative, the negative is defaulted to 0.

Algorithm 2: If the operation result is always negative, moreover algorithm 2 is not absolute value operation, system will default the result to 0.

6.7 Process PID control parameter

Analog feedback control system:

Pressure given quantity input through AI1 and 4-20mA signal feedback from pressure sensor input through AI2 are connected with PID adjustor built-in to compose the close loop control system, shown as Diagram 6-20:

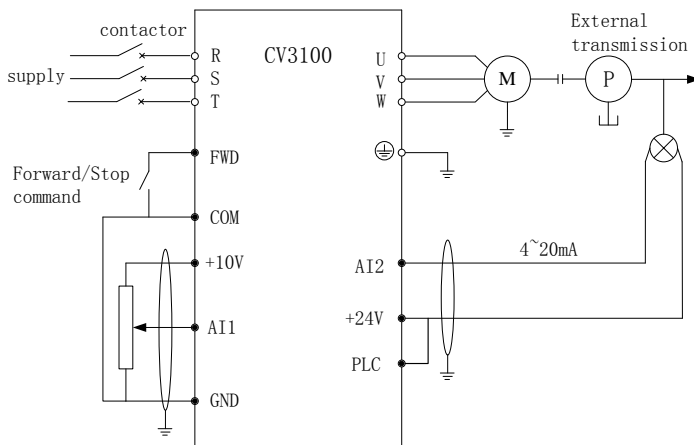

Diagram 6-20 Analog feedback control system

P6.00	PID actiong setting	Factory setting	00
	Setting range		00-11

LED single digit: Function setting

0: Close

1: Open

LED tens digit: PID availability selection

0: Automatic availability

1: Manual availability by defining of multi-function terminal

LED Hundreds & thousands digit: Reserved

PID function as followings:

PID gives comparison to the system ration and feedback quantity which was detected from the sensor to the object controlled, proceeding with operation of proportion, integral and differential coefficient to their deviation in order to adjust the inverter output frequency, applying for process control of physical quantity, such as flow, pressure, temperature and so on, the system network shown as Diagram 6-21:

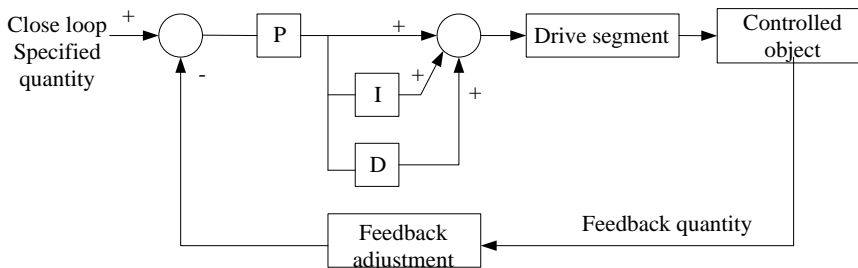

Diagram 6-21 PID system network

P6.01	PID given channels selection	Factory setting	1
Setting range	0	Keypad potentiometer setting	
	1	Digit setting	
	2	Reserved	
	3	Reserved	
	4	AI1 provision	
	5	AI2 provision	
	6	Terminal pluse provision	
	7	AI1+AI2	
	8	AI1-AI2	
	9	MIN { AI1,AI2 }	
10	MAX { AI1,AI2 }		

0: Keypad potentiometer setting

PID ration given by keypad potentiometer.

1: Digit setting

PID ration given by digit and parameter P6.03.

2: Reserved.

3: Reserved.

4: AI1 provision

PID ration given by exterior voltage signal AI1(0~10V).

5: AI2 provision

PID ration given by exterior current signal AI2(0~20mA/0~10V).

6: Terminal pulse provision

PID ration given by exterior pulse.

7: AI1+AI2

PID ration given by summation of AI1 and AI2 provision.

8: AI1-AI2

PID ration given by difference of AI1 and AI2 provision.

9: MIN {AI1,AI2}

PID ration given by the smaller one of AI1 and AI2.

10: MAX {AI1,AI2}

PID ration given by the bigger one of AI1 and AI2.

P6.02	PID Feedback channel selection	Factory setting	4
Setting range	4	AI1	
	5	AI2	
	6	Terminal pulse	
	7	AI1+AI2	
	8	AI1-AI2	
	9	MIN {AI1,AI2}	
	10	MAX {AI1,AI2}	

Note: The value of provision channel set can't be same as feedback channel, or else the ration will be same as feedback quantity, deviation value is 0, and PID can't work normally. In addition, there is without any sense if Feedback channel is set between 0 and 3.

P6.03	Specified digital quantity setting	Factory setting	0.00V
	Setting range	0.00—10.00V	

When PID specified channel selection is digit setting(P6.01=1), this parameter is used for setting the digital quantity value of PID control.

For constant pressure water supply close loop control system, setting of this parameter shall base on carefully considering the relationship between capacity and output feedback signal of manometer far away from the inverter.

For example, if the capacity manometer is 0-10Mpa and we need 6Mpa pressure toward 0-10V(0-20mA) voltage output, we can set digital quantity to 6.00V in order to get pressure of 6Mpa after stable adjustment of PID.

P6.04	Gain of feedback channel	Factory setting	1.00V
	Setting range	0.01—10.00	

When the feedback channel and specified channel are not at the same level, it can adjust the gains of feedback channel signal through this parameter.

P6.05	Polarity of feedback channel	Factory setting	0
	Setting range	0	Positive
		1	Negative

0: Positive

When the feedback signal is more than PID specified quantity, the inverter is asked to decrease frequency output, namely minish feedback signal in order to balance PID. Giving out winding of tension control system and constant pressure water supply system are all fit for this situation.

1: Negative

When the feedback signal is more than PID specified quantity, the inverter is asked to increase frequency output, namely minish feedback signal in order to balance PID. Drawing in winding of tension control system and central air-condition control system are all fit for this situation, shown as

Diagram 6-22:

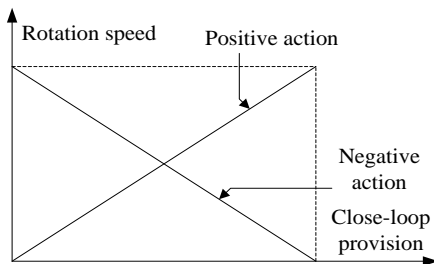

Diagram 6-22 Positive & negative charactercharacteristic

P6.06	Proportion gain P	Factory setting	1.00
	Setting range	0.01—10.00	
P6.07	Integral time Ti	Factory setting	1.00s
	Setting range	0.1—200.0s	
P6.08	Differential coefficient time Td	Factory setting	0.0s
	Setting range	0.0—10.0s	

The parameters of PID controller should be set according to the system properties and the actual situation.

Proportion gain P: Decide the whole PID controller adjustment intension, The larger P keeps , the stronger the adjustment intension gets.

Integral time Ti : Decide the speed(quick or slow) ,to which PID controller integral adjust the deviation between PID feedback quantity and specified quantity

Differential coefficient time Td: Decide the intension, to which PID controller adjusts the variation rate of deviation between PID feedback quantity and specified quantity, lies on the differential coefficient time.

Note: If P6.08=0.0, the function of differential coefficient is invalid.

P6.09	Sampling time T	Factory setting	0.00s
	Setting range	0.00—10.00s	

The sampling period is of the feedback quantity, adjust PID once every sampling period, the longer the sampling period goes by, the slower the response gets, but the suppression effect to disturbance signal is better, so setting is done according to the concrete situation.

Note: If P6.09=0.00, sampling finishes automatically.

P6.10	Deviation margin	Factory setting	0.0%
	Setting range	0.0—20.0%	

The deviation margin refers the ratio between deviation absolute value of feedback quantity and specified quantity and basic value 10v. When the ratio value is lower than the setting parameter value, PID adjustment will not be done.

This function is used for the system without high control accuracy but with avoiding frequent adjustment,the correct setting of this function is good for improving the stability of system .

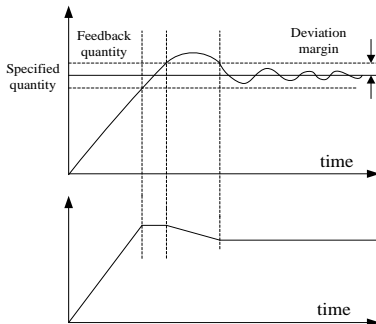

Diagram 6-23 Deviation margin

P6.11	Closed-loop presetting frequency	Factory setting	0.00Hz
	Setting range	0.0- upper limit frequency	
P6.12	Duration of presetting frequency	Factory setting	0.0s
	Setting range	0.0—6000.0s	

The parameters define the inverter running frequency and time before PID function available when the PID control is valid. In some control system, in order to make the controlling object reaching to the predetermined value quickly, the inverter will be forcibly set to output some frequency P6.11 until predetermined time p6.12. When the control object reach to the control target, then PID is workable to improve the response speed.

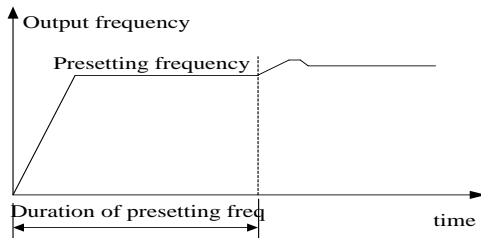

Diagram 6-24 Close-loop presetting frequency operation

P6.13	Sleeping threshold	Factory setting	10.00V
	Setting range	0.0—10.00V	

This parameter defines inverter feedback limit from working status to sleeping status. If the feedback value is more than the setting value, when the inverter output frequency drops to low limit frequency after the delay time of P6.15, then the inverter go into sleeping.(0 rotate speed running)

P6.14	Waking threshold	Factory setting	0.00V
	Setting range	0.0—10.00V	
P6.15	Sleep/Wake waiting time	Factory setting	300.0S
	Setting range	0.1—600.0S	

P6.14 parameter defines inverter feedback limit from sleeping status to working status, P6.15 parameter defines the transferring time between sleep and wake status. If the feedback value is less than the setting value, the inverter will wake up from sleeping status after P6.15 waiting delay time and start to run again.

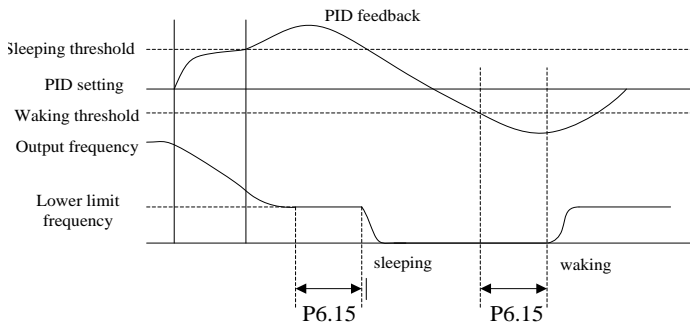

Diagram 6-25 Sleeping & waking function

6.8 Programmable running parameter

P7.00	Programmable running control	Factory setting	000
	Setting range	000-114	

LED single digit: Running mode selection

- 0: No action
- 1: Single circulation(Simple PLC)
- 2: Continuous circulation (Simple PLC)
- 3: Holding ultimate value after single circulation (Simple PLC)
- 4: Wobbling frequency running

LED tens digit: Programmable multi-step speed (PLC) running availability selection

- 0: Automatic availability
- 1: Manual availability by defining of multi-function terminal

LED Hundreds digit: Wobbling frequency running availability mode

- 0: Automatic availability
- 1: Manual availability by defining multi-function terminal.

LED thousands digit: Reserved

Detailed function explanation as below:

0: No action

Programmable multi-step speed running is invalid.

1: Single circulation

The inverter will stop automatically after single circulation, startup of which asks for running command input. If the running time of some stage is zero, it will jump this stage to enter into next stage when running, details shown as Diagram 6-26:

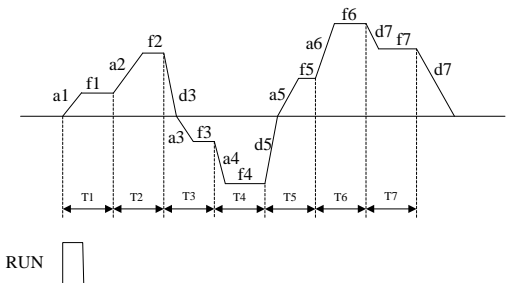

Diagram 6-26 Single circulation running

f1~f7: Running frequency corresponding from Stage 1 to 7;
 T1~T7: Running time corresponding from Stage 1 to 7;
 a1~a6: Acceleration time corresponding from Stage 1 to 7;
 d3、d5 & d7: Deceleration time for stag 3、stage 5 and stage7.

Note:

Multi-step speed running time must be longer than acceleration time, however, this parameter only defines the running time, so it is necessary to learn the calculation of multi-step speed running acceleration/deceleration time, shown as following:

Multi-step speed acceleration/deceleration time= { (Current multi-step speed frequency- multi-step speed starting frequency) ÷Basic running frequency } × Acceleration & Deceleration time (P0.14, P0.15)

For example, if basic running frequency is 50Hz, acceleration time is 10S, and deceleration time is 20S, during multi-step speed running, the accelerating time for inverter increasing from 20HZ to 30HZ as below:

$$T1= \{ (30\text{HZ}-20\text{HZ}) \div 50\text{HZ} \} \times P0.14=2\text{S}$$

Decreasing from 30HZ to 10HZ, the decelerating time as below:

$$T2= \{ (30\text{HZ}-10\text{HZ}) \div 50\text{HZ} \} \times P0.15=8\text{S}$$

2: Continuous circulation

When the stop command is input, the continuous circulation will be ceased, shown as Diagram 6-27:

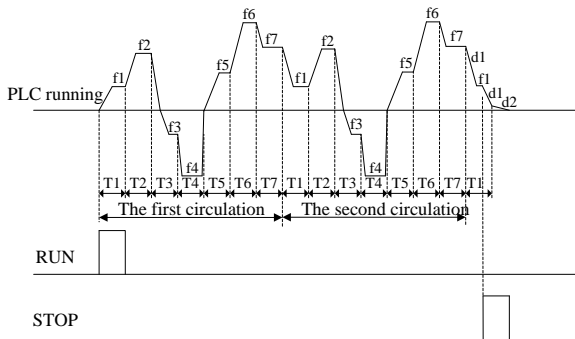

Diagram 6-27 Continuous circulation

3: Holding ultimate value after single circulation

As is shown in Diagram 6-28, the inverter finishes multi-step speed single circulation, then it will keep the running frequency and direction of last section, of which running time is not set to “0”.

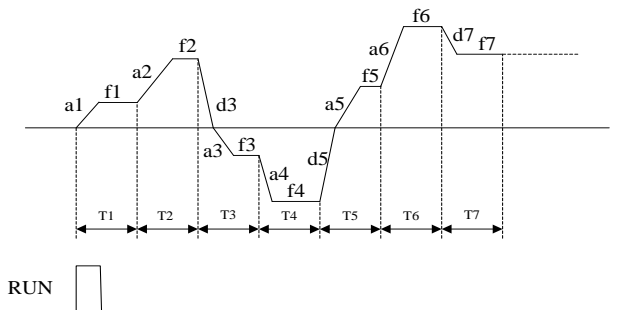

Diagram 6-28 Holding ultimate value after single circulation

4: Wobbling frequency running

The inverter output frequency varies periodically within accel & decel time preset. It mainly applies for the system, such as textile of synthetic fibre machine of which speed changes according to different diameter in the front and the back of tubeshown as Diagram 6-29:

P7.01	Stage 1 running time	Factory setting	10.0s
P7.02	Stage 2 running time	Factory setting	10.0s
P7.03	Stage 3 running time	Factory setting	10.0s
P7.04	Stage 4 running time	Factory setting	10.0s
P7.05	Stage 5 running time	Factory setting	10.0s
P7.06	Stage 6 running time	Factory setting	10.0s
P7.07	Stage 7 running time	Factory setting	10.0s
P7.08	Reserved		
	Setting range	0.0—6000.0s	
P7.09	Multi-step speed running direction 1	Factory setting	0000
P7.10	Multi-step speed running direction 2	Factory setting	-000
	Setting range	0000—1111(0:Rotation 1:Reverse)	

These above parameters are used for providing the running time, running direction and acceleration & deceleration time of simple programmable multi-step speed, which are

only effective when multi-step speed running function is available.

The priority of programmable multi-step speed is higher than external terminals multi-step speed

P7.11	Wobbling frequency running mode	Factory setting	000
	Setting range	0000—111	

LED single digit: Reserved

LED tens digit: Wobbling range control

0: Fixed

1: Variable

LED hundreds digit:

Selection of wobbling frequency start up mode after power off

0: Start up basing on memory before stop

1: Restart

LED thousands digit:

Selection of Wobbling frequency status storage after power off

0: Storing after power off

It recovery status automatically and run from the broken status after power-on.

1: Not storing

It restarts to run in wobbling frequency after startup.

P7.12	Wobbling pre-setting frequency	Factory setting	10.00Hz
	Setting range	0.00Hz—upper limit frequency	
P7.13	Wobbling presetting frequency waiting time	Factory setting	0.0s
	Setting range	0.0—3600.0s	

Presetting frequency is the operating frequency of which before the inverter running into wobbling frequency control mode or which after the inverter running out of wobbling frequency control mode. If P7.00=4, the inverter will run in wobbling frequency presetting frequency after startup and ten run into wobbling frequency running mode after the wobbling frequency presetting frequency waitingtime . If the running command is controlled by terminal input, parameter P7.13 is invalid.

Note:

If the hundreds digit of parameter P7.11 is set to “0”, the wobbling presetting frequency is invalid; If it is set to “1”, then each time wobbling frequency running

starts after stop, with frequency starting from wobbling presetting frequency point. Function of thousands digit of parameter P7.11 is to decide whether the former running information be stored or not when the power supply is on after off; If the storage is effective, the hundreds digit of parameter P7.11 will decide whether the first startup runs from the wobbling presetting frequency or not; If the storage is disabled, the first startup will run from the wobbling presetting frequency during each running under power on. In addition, resetting to the wobbling frequency running status can be realized by the multi-function terminal that is defined as Wobbling freq. status reset.

P7.14	Wobbling frequency width	Factory setting	10.0%
	Setting range	0.0—50.0%	

This parameter is the rate of wobbling frequency width.

When the fixed wobbling frequency is selected, the actual wobbling frequency width is calculated as following:

Wobbling frequency width = P7.14 × upper limit frequency

When the variable wobbling frequency is selected, the actual wobbling frequency width is calculated as following:

Wobbling frequency width = P7.14 × (Wobbling frequency centre frequency basic P7.18 + P0.01 frequency setting)

P7.15	Skip frequency	Factory setting	0.0%
	Setting range	0.0—50.0%	

It is the rapidly degressive extent during wobbling frequency running, when the frequency arrives at the wobbling upper frequency; on the contrary, when it arrives at the wobbling lower frequency.

Actual skip frequency = P7.15 × Wobbling frequency width value

P7.16	Wobbling frequency period	Factory setting	10.0s
	Setting range	0.1—3600.0s	

This parameter is used for setting one time wobbling frequency period.

P7.17	Triangle wave risetiem	Factory setting	50.0%
	Setting range	0.0—100.0%	

This parameter define the wobbling frequency running time from its lower limit frequency to upper limit frequency, namely acceleration time of wobbling period.

Actual triangle wave risetime = Wobbling frequency period × P7.17

P7.18	Norm of central wobbling freq.	Factory setting	10.00Hz
	Setting range	0.00—Maximum frequency	

It is the normal value of central output frequency of the inverter.

Actual wobbling center frequency is the accumulated value of this parameter value and the setting frequen from external frequency setting passage P0.01.

Actual wobbling center frequency = [P7.18] + Frequency set by the channel which is specified by P0.01.

Note: Wobbling operating frequency is restricted by the upper and lower limit frequency. Incorrect setting will lead to abnormal running of wobbling frequency.

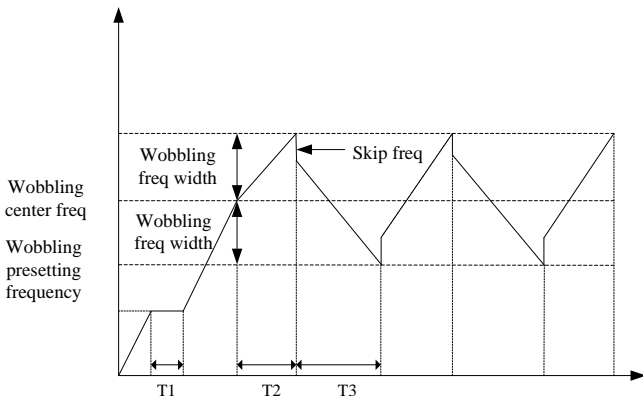

Diagram 6-29 Wobbling frequency setting

Note:

Priority to frequency setting as below:

Jog operating frequency > Wobbling frequency operating frequency > PID provision operating frequency > Programmable multi-step speed operating frequency > Multi-function terminal selection frequency > frequency setting channel selection.

6.9 Communication parameter

P8.00	Local communication address	Factory setting	1
	Setting range	0—31	

This parameter is used to identify the address when the inverter is set to RS485 communication, the address is unique.

0: Master station

It means the inverter is used as master when serial port communicates, to control the running of the other connected inverters.

1-31: Slave station

It means the inverter is used as slave to receive the data from PC or master station. The inverter only received the data form PC or master in accordance with the address marked.

P8.01	Communication scheme	Factory setting	013
	Setting range	0000—0125	

This parameter defines the RS485 communication baud rate. In order to normal communication, all relative communication parties must be set the same baud rate and prescribed the same communication data format.

LED single digit: Baud rate settin

- 1: 2400BPS
- 2: 4800BPS
- 3: 9600BPS
- 4: 19200BPS
- 5: 38400BPS

LED tens digit: Data format

- 0: No checkout
- 1: Even checkout
- 2: Odd checkout

LED hundreds digit: Reserved

LED thousands digit:

- 0: Feedback information when modifying parameters
- 1: No feedback information when modifying parameters

P8.02	Communicating overtime checkout time	Factory setting	10.0s
	Setting range	0.0-100.0s	

If the inverter can't receive correct data during the interval time defined by this parameter, it will take for communication failure and stop running or maintain the status according to setting of communication failure action manner.

P8.03	Response delay	Factory setting	5ms
	Setting range	0-1000ms	

This parameter defines the delay time during the inverter correctly receiving the information code from PC and then sending out data frames back to PC.

P8.04	Linkage proportion setting	Factory setting	1.00
	Setting range	0.01-10.00	

This parameter is used to set weight coefficient of frequency command received from PC by RS485 interface. The actual running frequency is equal to the value off this parameter multiplying with frequency setting command value received by RS485 interface. More running frequency proportion can be set by this parameter in Linkage control system .

6.10 Protection parameter

P9.00	Motor overload stall prevention factor	Factory setting	105%
	Setting range	30%—110%	

In order to carry out effective overload protection for different model motors , setting motor overload stall prevention factor reasonably and limiting inverter allowable output max current are necessary. Motor overload stall prevention factor is the percentage of motor rated current to inverter rated output current.

When the inverter and motor are at the same power rate, motor overload stall prevention factor can be set to 100% generally.

When the capacity of inverter is big than motor, the factor setting shall be reasonable in order to execute effective overload stall prevention to the motor, shown as the following Diagram:

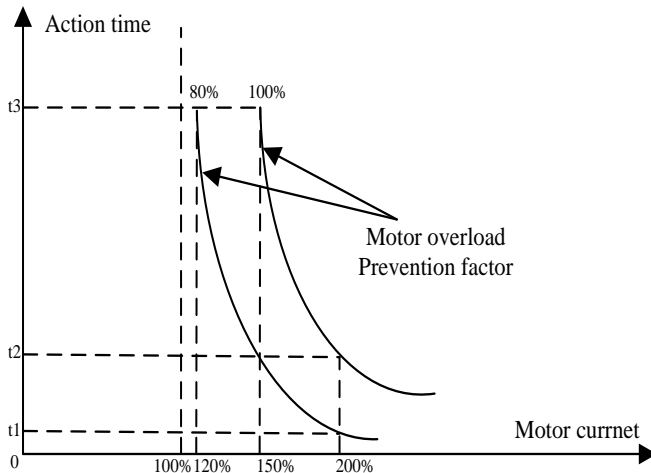

Diagram 6-30Curve for overload stall prevention of motor

The motor prevention factor is decided by following formula:

Motor overload stall prevention factor = Allowable max load current/inverter rated output current ×100%

Generally, allowable max load current is the motor rated current.

P9.01	Low voltage prevention level	Factory setting	400V (380V type)
	Setting range	360V—480V (380V type)	220V-240V (220V type)

This parameter defines the allowable low voltage of DC bus when normal working of inverter.

Note:

Excessively low grid voltage will cause reduction of motor torque output. For constant power load or constant torque load, over low grid voltage can bigger input and output current of inverter, accordingly reducing the running reliability of inverter. So the inverter needs to be devaluated when it works under low grid voltage for long time.

P9.02	Over voltage prevention level	Factory setting	700V (380Vtype)
	Setting range	660—760V (380V type)	330-380V (220V type)

This parameter defines the threshold of voltage stall prevention during motor deceleration. If the inverter DC bus voltage feedback exceeds the value specified by this parameter, the inverter will adjust the deceleration time automatically to decelerate or maintain constant output frequency until the DC bus voltage drops below the over voltage prevention level, it will resume deceleration, shown as Diagram 6-31.

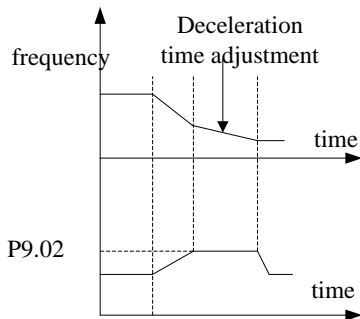

Diagram 6-31 Over voltage prevention level

P9.03	Over current stall prevention level	Factory setting	180%
	Setting range	80%—220%	

During periods of rapid acceleration or excessive load on the motor, the inverter output current may increase abruptly and exceed the value specified by P9.03. When over current occurs, the inverter will cease to accelerate and will maintain a constant output frequency until the current falls below the preset value. It will resume acceleration when the current drops below the preset value.

During constant speed running, the inverter output current may also exceeds the value specified by P9.03. In order to avoid over current stall, the inverter will adjust the output frequency to restrict the current in specified range.

6.11 Senior function parameter

PA.00	Zero frequency running threshold	Factory setting	0.00Hz
	Setting range	0.00—50.00Hz	
PA.01	Zero frequency hysteresis	Factory setting	0.00Hz

	Setting range	0.00—50.00Hz
--	---------------	--------------

This parameter defines the characteristic when the frequency passes zero.

If the frequency setting is specified by analog signal, there is certain interference to the inverter output due to the instability of analog signal. The lag function of this parameter is used to avoid fluctuation around zero frequency.

Taken example to analog input channel AI1 as below:

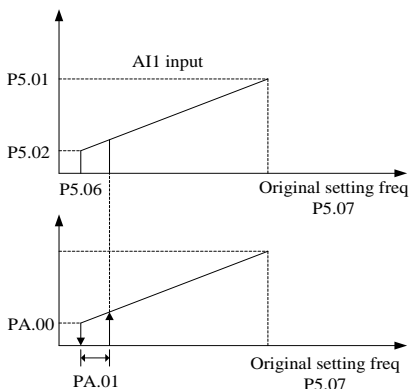

Diagram 6-32 Zero frequency hysteresis running

If the running command is given and the above parameters (PA.00、PA.01) are not be set, the frequency output will be rigidly according to the relationship between analog voltage and frequency. When the factory setting value of PA.00 and PA.01 are changed, the inverter will not start to run if the AI1 input frequency value is less than the summation by PA.00 and PA.01; if the it is equal to or exceeds the summation by PA.00 and PA.01, can the motor start to run and accelerate to the frequency corresponding to AI1 input according to preset acceleration time.

During decelerating, when the frequency output reaches the summation by PA.00+PA.01, the inverter will not stop running, only when the frequency corresponding to AI1 input reaches or be lower than PA.00, it can stop running.

This function can be used to realize the sleeping function of inverter as well as energy saving operating.

PA.02	Energy consuming braking initial voltage	Factory setting	740V
	Setting range	600—750V	
PA.03	Energy consuming braking action percentage	Factory setting	50%
	Setting range	10—100%	

The above two parameters are used for defining the action of brake unit built-in the inverter. If the inverter DC voltage is higher than the energy consuming braking initial voltage, brake unit acts. If there is resistance connecting with it, the inverter inside current pumping voltage energy will be released by the resistance to make DC voltage reducing. When dc voltage reducing to some value, the inverter built-in unit will closed.

Energyconsumingbraking action percentage is used for defining the average voltage value inflicted upon the resistance during energy consuming braking. Bigger value of PA.03 leads to more quickly energy consuming.

PA.04	Cooling fan control	Factory setting	0
	Setting range	0	Automatic control
		1	Working during power on

0: Automatic control

The fan always works during the inverter runs. When the inverter stops and the temperature of radiator is below 40℃ , the fan will stop working.

1: Working during power on

It suits for some application that asks for non-stop running of the fan.

PA.05	UP/DOWN terminal modifying speed	Factory setting	1.00Hz/S
	Setting range	0.01Hz~100.0Hz/S	

When the frequency command is input by UP/DOWN terminals, it can adjust the rise and decline speed of frequency output through this parameter setting.

PA.06	Over modulation enabling	Factory setting	0
	Setting range	0	Forbidden
		1	Allowable

When PWM works under the modulation percentage more than 1, allowable over modulation enabling can improve the frequency output and torque output. However, the function can increase voltage harmonic waves output either, resulting in bad current waves output.

Note: When the grid voltage is less than 15% of rated voltage or the situation that the output torque under variable frequency running is lower than that under industrial frequency happens(the inverter drives heavy duty for long), this function is allowable to use.

PA.07	Timer value setting	Factory setting	0
	Setting range	0~65536S	

This function is used to set the timing setting, minimum unit setting unit is 1s, when the setting is 0, it is invalid.

PA.08	The Rang of AO1 output	Factory setting	0
	Setting range	0	0:0~10V/0~20mA
		1	1: 2~10V/4~20mA

This function is used to set AO1 output type. 0~10V/0~20mA and 2~10V/4~20mA output are optionals.

Note:

The nonstandard edition with Double analog output can realize AO1 and AO2 output setting separately.

PA.08(FA.08)----AO1/AO2 output range optional

LED single digit--AO1 output range optional:

0----0~10V/0~20mA

1----2~10V/4~20mA

LED ten digit--AO2 output range optional:

0----0~10V/0~20mA

1----2~10V/4~20mA

Chapter 7 Troubleshooting

7.1 Failure and countermeasure

When the inverter occurs abnormality, LED digitron will display the function code and information about corresponding fault, fault relay will operate and inverter will stop outputting, when the fault occurs, in case that the motor still rotates, it will perform free stop, till it stops rotating. The permissible fault of CV3100 series is shown as table 7-1, the fault code display range is Er00-Er18. When finding the fault of inverter, user shall examine according to this table first and record the symptom in detail, and may contact our after-sale service center or our sales agencies if need technical service.

7.2 Enquiry of fault record

This series of inverters keeps the code of latest three times faults and the inverter operating parameters of the last fault helping user to find out the fault reason. All fault information is stored in group D19-D27 parameters; user can refer to the keyboard operating method to enter into D group parameters for inquiring the information concerned.

7.3 Fault reset

Please choose following any operation if requiring the fault inverter to recover normal running.

- (1) When the inverter displays the fault code, you can press  key to reset.
- (2) When any one terminal of DI1~DI6 has been set to external **RESET** input (P4.00~P4.05=20), it can break after closing with COM terminal
- (3) Cut off power supply and restart



Warning:

- (1) Prior to resetting, user must find the fault reason thoroughly and remove the fault; otherwise, it would result in irremediable defect of inverter.
- (2) User shall find the reason if the inverter can't be reset or fault reoccurs after resetting; otherwise, the consecutive resetting would cause the damage of inverter.
- (3) After delaying 5 min, the inverter can be reset when it performs the operation of overload and overheating protection.

7.4 Fault code and countermeasure

7-1 Table of fault code and solution

Fault code	Fault name	Possible cause	Solution
Er00	Over current at accelerating operation	① Too short accelerating time ② Ultra large load inertia. ③ Unsuitable V/F curve ④ Ultra low main voltage ⑤ Too small inverter power ⑥ Restart the rotating motor	① Extend accelerating time ② Reduce the load inertia ③ Reduce torque boost value or adjust V/F curve ④ Examine input power supply ⑤ Choose the inverter of large power ⑥ Set the speed-detection start function
Er01	Over current at decelerating operation	① Too short decelerating time ② Ultra large load inertia. ③ Too small inverter power	① Extend decelerating time ② Reduce the load inertia ③ Choose the inverter of large power
Er02	Over current at constant speed operation	① Abnormal input voltage ② Load occurs abrupt change or abnormality ③ Too small inverter power	① Examine input power ② Examine load or reduce the abrupt change of load ③ Choose the inverter of large power
Er03	Over voltage at accelerating operation	① Abnormal input voltage ② Restart the rotating motor	① Examine input power ② Set the speed-detection start function
Er04	Over voltage at decelerating operation	① Too short decelerating time ② There is energy feedback load ③ Abnormal input power supply	① Extend decelerating time ② Add braking power of external energy consumption braking unit ③ Examine input power
Er05	Over voltage at constant speed operation	① Abnormal input voltage ② Ultra large load inertia.	① Examine input power ② Choose energy consumption braking unit
Er06	Over voltage at stopping	① Abnormal input supply voltage	① Examine input supply voltage
Er07	Under voltage at operating	① Abnormal input voltage	① Examine supply voltage
Er08	Phase failure of input power	① Input power occurs phase failure or abnormality	① Examine input power supply

Fault code	Fault name	Possible cause	Solution
Er09	Module fault	① Inverter outputs short circuit or earthing. ② Instant over current of inverter ③ Too high environment temperature ④ Air flue is blocked or fan is damaged ⑤ DC auxiliary power supply occurs fault ⑥ Abnormal controlpanel	① Examine the connecting wire; ② Refer to solution against over current ③ Clean the air flue or change the fan; ④ Ask for service from manufacturer or agency.
Er10	Over heat radiator	① Too high environment temperature ② Fan is damaged ③ Flue is blocked	① Lower environment temperature ② Change the fan ③ Clean the flue and change the ventilation condition;
Er11	Overload of inverter	① Too high torque boost or unsuitable V/F curve ② Too short accelerating time ③ Too large load	① Reduce the torque boost and adjust the V/F curve. ② Extend accelerating time ③ Reduce load or choose the inverter of large power
Er12	Overload of motor	① Too high torque boost or unsuitable V/F curve ② Too low main voltage ③ Locked rotor of motor or too large abrupt change of load ④ Incorrect setting of motor overload protection factor	① Reduce the torque boost value or adjust the V/F curve. ② Examine main voltage ③ Examine load ④ Set the motor overload protection factor correctly
Er13	Fault of peripheral equipment	① Fault input terminal of peripheral equipment is close	① Disconnect the terminal input and remove the fault.
Er14	Fault of serial port communication	① Improper setting of baud rate ② False of serial port communication ③ Without upper machine communication signal	① Set baud rate correctly ② Examine communication cable and ask for service ③ Check whether PC works and the connection is correct.
Er15	Reserved		
Er16	Incorrect current detection	① The current detecting device is damaged or the circuit occurs fault ② DC auxiliary power is damaged	① Ask for service from manufacturer or agency. ② Ask for service from manufacturer or agency.
Er17	Fault of communication between keyboard and control panel	① The circuit connecting keyboard and control panel occurs fault ② The terminal is poor in connecting	① Ask for service ② Examine and reconnect
Er18	CPU fault	--	--

Chapter 8 Maintenance

8.1 Maintenance

In case of change of service environment for inverter, such as temperature, humidity, smog and aging of inverter internal parts, the inverter fault may occur. Therefore, the inverter must be examined daily and given the regular maintenance in period of storing and using.

8.1.1 Daily maintenance

When the inverter is turned on normally, please make sure the following items:

- (1) Whether the motor has abnormal noise and vibration.
- (2) Whether inverter and motor heat or occur abnormality.
- (3) Whether environment temperature is too high.
- (4) Whether the value of load ammeter is in conformity with the former.
- (5) Whether the fan of inverter rotates normally.

8.2 Regular maintenance

8.2.1 Regular maintenance

Before the inverter is maintained and checked, the power supply must be cut off, in addition, the monitor shall have no display and main circuit power indicator lamp goes out. The examined content is shown as table 8-1.

Table 8-1 Regular examined contents

Item	Content	Solution
Screw of main circuit terminal and control circuit terminal	Whether the screw is slack	Tightened by screwdriver
Heat sink	Whether there is dust on it	Blow it away with the dry compressed air of 4-6kg/cm ² Pressure
PCB(printed circuit board)	Whether there is dust or vapor on it	Clean the surface of PCB board
Fan	Whether it runs normally and makes abnormal sound or vibration ,and whether the accumulated time runs up to more than 20000 hours	Change the fan
Power unit	Whether there is dust on it	Clear the foreign matter
Aluminum electrolytic capacitor	Whether it has color change,peculiar smell,bubbling,liquid leakage	Changed Aluminum electrolytic capacitor

8.2.2 Regular maintenance

In order to make the inverter run normally for a long time, the electronic elements mounted in inverter shall be maintained regularly. And the service life of electronic elements is different with the service environment and service condition. The maintenance period of inverter as shown in the table 8-2 is provided for referring.

Table 8-2 Changing time of inverter parts

Part name	Standard changing time
Fan	2~3 years
Electrolytic capacitor	4~5 years
PCB	5~8 years
Fuse	10 years

Applicable condition for changing time of aforementioned inverter parts

- (1) Environment temperature: Annual average is 30°C.
- (2) Load factor: Less than 80%
- (3) Running time: Less than 12 hours every day

Warranty Agreement

1. Warranty scope only includes the frequency inverter body.
2. For normal use, the drives fail or be damaged within 18 months, the company is responsible for the warranty; more than 18 months, will charge a reasonable maintenance costs.
3. Warranty period starting time is the date of manufacture.
4. Within 18 months, some maintenance fees should be charged in the following situations:
 - Do not follow the operating manual steps to cause the damage to the inverter.
 - Damaging the inverter because of fires, water, abnormal voltage and etc..
 - Wiring error causes the damage to the drive.
 - Damaging the inverter because of using non-normal functions .
5. Related services fees are according to the actual costs. If the fees are written in the contract , the contract prevails.
6. Please keep this card and show it to the maintenance supporter when the frequency inverter is repaired
7. If the problems happen, please contact directly with the supplier, or with our company.

CV3100 Series Inverter warranty

User's Company:	
Address:	
Zip:	Contact:
Phone:	Fax:
Machine series number:	
Power:	Machine series:
Contract Number:	Purchase Date:
Service company:	
Contact:	Phone:
Repairer:	Phone:
Service Date:	
User opinions and reviews: <input type="checkbox"/> Good <input type="checkbox"/> Better <input type="checkbox"/> General <input type="checkbox"/> Poor Other comments: User's Signature: _____ day month year Company re-visitrecord: Other:	